

EMHEATER

User's Manual

EM11 Series Frequency Inverter

EM11 Series Inverter User's Manual



China EM Technology Limited

Address: No.80, Baomin 2 road, Xixiang, Bao'an District, Shenzhen, China

Phone: 86-0755-29985851

Fax: 86-0755-29970305

Zip code: 518101

Website: [Http://www.emheater.com](http://www.emheater.com)

China EM Technology Limited

Preface

Thank you for purchasing the EM11 series frequency inverter developed by China EM Technology Limited.

The high-performance EM11 series vector control frequency inverter has the following features:

1. Multiple voltage classes

It provides coverage of single-phase 220 V, three-phase 220 V, three-phase 380 V, three-phase 480 V, three-phase 690 V and three-phase 1140 V.

2. Support multiple motor types

It supports vector control of three-phase AC asynchronous motor and three-phase AC permanent magnet synchronous motor (PMSM).

3. Diversified control modes

It supports four control modes: sensor-less vector control (SVC), closed-loop vector control (VC) and V/F control and V/F separately control.

4. Multiple communication protocols

It supports communication via Modbus-RTU, Profibus-DP and CANopen bus.

5. Multiple encoder types

It supports various encoders such as differential encoder, open-collector encoder, resolver and UVW encoders.

6. Super SVC algorithm

It adopts high-speed response, enhanced low-frequency loading capacity and supports torque control of SVC, which will bring you a new using experience.

EM11 series frequency inverter is a continuable and vigorous product, and we will offer customized service to our customers!

Before unpacking, please check carefully:

- Whether the nameplate model of frequency inverter are consistent with your order ratings. The box contains the frequency inverter, user manual.
- Whether the frequency inverter is damaged during transportation. If you find any omission or damage, please contact us or your local supplier immediately.

First-time Use

For the users who use this product for the first time, read the manual carefully. If in doubt concerning some functions or performances, contact the technical support personnel to ensure correct use.

Due to the continuous improvement of frequency inverter, this document will be updated without prior notice.

EM11 series Frequency inverter complies with the following international standards. All products have passed the CE certification.

IEC/EN61800-5-1: 2003 Variable speed electric drive system safety requirements;

IEC/EN61800-3: 2004 Variable speed electric drive system, Part 3: The Electro Magnetic Compatibility (EMC) Standards of Product and its specific testing methods.

Note:

- **There are all parameters list integrated at appendix II.**
- **First time use this inverter, please do motor auto-tuning according to “d0-30”page 104.**

Table of Contents

1. Safety Information and Precautions	1
1.1 Safety Information.....	1
1.1.1 Before installation	1
1.1.2 During installation	1
1.1.3 wiring	1
1.1.4 Before power-on	2
1.1.5 After power-on	2
1.1.6 During operation.....	3
1.1.7 Maintenance	3
1.2 General Precautions.....	3
1.2.1 Motor insulation test.....	3
1.2.2 Thermal protection of motor	3
1.2.3 Running at over 50 Hz.....	3
1.2.4 Vibration of mechanical device	4
1.2.5 Motor heat and noise	4
1.2.6 Voltage-sensitive device or capacitor at output side of the Frequency inverter.....	4
1.2.7 Contactor at the Input/Output side of the frequency inverter	4
1.2.8 When input voltage is over rated voltage range	4
1.2.9 Prohibition of three-phase input changed into two-phase input	4
1.2.10 Surge suppressor.....	4
1.2.11 Altitude and de-rating	4
1.2.12 Some special usages	4
1.2.13 Disposal	5
1.2.14 Adaptable Motor.....	5
2. Product Information	6
2.1 Designation Rules	6
2.2 Nameplate.....	6
2.3 EM11 Series Frequency Inverter.....	6
2.4 Technical Specifications.....	8
2.5 Product appearance and installation dimension.....	11
2.5.1 Product appearance.....	11
2.5.2 Appearance and Installation Hole Dimension (mm) of EM11 Frequency Inverter	12
2.5.3 Appearance and installation dimension of external keypad (keypad tray)	13
2.6 Options	13
2.7 Daily maintenance of frequency inverters.....	14
2.7.1 Daily maintenance	14
2.7.2 Regular inspection	14
2.7.3 Wearing parts replacement	15
2.7.4 Storage of the frequency inverter	15
2.8 Warranty Items	15
2.9 Selection Guide of braking component	15
2.9.1 Selection of braking resistance value	16
2.9.2 Selection power of braking resistor	16
2.9.3 Braking resistor connection description	17
3. Installation of Frequency Inverter	18
3.1 Installation environment.....	18
3.2 Installation direction and space	18
3.3 Peripheral Devices Connection Diagram	19
3.4 Instructions of Main Circuit Peripheral Devices	20
3.5 Model Selection of Main Circuit Peripheral Devices.....	21
3.6 Removal and mounting of operating panel and cover	22
3.6.1 Removal and mounting of operating panel (keypad)	22
3.6.2 Removal and Mounting of Frequency Inverter	22
3.7 Connection Terminals Diagram Description	23
3.8 Sketch and Description of Main Circuit Terminals	24

3.8.1 Function and description of Main Circuit Terminals	24
3.9 Cautions for Main Circuit Wiring	25
3.9.1 Power Supply Wiring	25
3.9.2 Motor Wiring	25
3.9.3 Grounding Wiring	26
3.9.4 Countermeasures for Conduction and Radiation Interference	26
3.10 Control Circuit and Main Circuit Terminals Description	27
3.10.1 Control Circuit and Main Circuit Wiring	27
3.10.2 Control Circuit Terminal Layout	28
3.10.3 Description of control circuit terminals	28
3.10.4 Wiring of Analog Input Terminals	29
3.10.5 Wiring of Multi-functional Input Terminals	30
3.10.6 Wiring of digital output terminals when using internal and external power supply	30
3.10.7 Description of Control Circuit Jumper	31
4. Operation and display	32
4.1 Instruction of operation and display	32
4.2 Viewing and Modifying Function Codes	33
4.3 Parameter Display Mode	34
4.4 The operation of User-defined Fast Menu of Parameters	35
4.5 Monitoring Status Parameters	36
4.6 Password Setting	36
4.7 Motor parameter auto-tuning	36
5. Description of Function Codes	38
5.1 Group b0: Basic Function Parameters	38
5.2 Group b1: Start/Stop Control Parameters	46
5.3 Group b2: Auxiliary Functions	49
5.4 Group b3: Input Terminals	54
5.5 Group b4: Output Terminals	60
5.6 Group b5: Pulse/Analog input terminals	68
5.7 Group b6: Pulse/analog output terminals	71
5.8 Group b7: Virtual digital input (VDI)/digital output (VDO) terminals	72
5.9 Group b8: AI/AO Correction	75
5.10 Group b9: Operation Panel and Display	76
5.11 Group bA: Communication parameters	79
5.12 Group bb: Fault and Protection	81
5.13 Group bC: Fault detection Parameters	89
5.14 Group C0: Process Control PID Function	90
5.15 Group C1: Multi-function	95
5.16 Group C2: Simple PLC	96
5.17 Group C3: Swing Frequency, Fixed Length and Count	99
5.18 Group d0: Motor 1 Parameters	101
5.19 Group d1: Motor 1 vector control parameters	105
5.20 Group d2: Motor 1 V/F Control Parameters	110
5.21 Group d3 to d5: Relevant parameters of motor 2	114
5.22 Group d6: Control Optimization Parameters	114
5.23 Group U0: Monitoring Parameters	116
5.24 Group A0: System parameters	121
5.25 Group A1: User-Defined Function Codes	123
6. EMC (Electromagnetic compatibility)	125
6.1 Definition	125
6.2 EMC Standard Description	125
6.3 EMC Guide	125
6.3.1 Harmonic Effect	125
6.3.2 Electromagnetic Interference and Installation Precautions	125
6.3.3 Handling method for the interferences of the surrounding equipment on the inverter	126
6.3.4 Handling method for the interferences of frequency inverter on the surrounding equipment	126
6.3.5 Leakage current and handling	126

6.3.6 Precautions for Installing EMC input filter at the input end of power supply	127
7. Fault Diagnosis and Solution	128
7.1 Fault Alarm and Countermeasures	128
7.2 Common Faults and Solutions	132
Appendix I. Modbus communication protocol	134
I. About Protocol	134
II. Application Methods	134
III. Bus structure	134
Appendix II. Function Code Table	143
Warranty Agreement	182

1. Safety Information and Precautions

In this manual, the notices are graded based on the degree of danger:

 **Danger:** Indicates that failure to comply with the notice will result in severe personal injury or even death.

 **Warning:** Indicates that failure to comply with the notice will result in personal injury or property damage.

Read this manual carefully so that you have a thorough understanding. Installation, commissioning or maintenance may be performed in conjunction with this chapter. EMHEATER will assume no liability or responsibility for any injury or loss caused by improper operation.

1.1 Safety Information

1.1.1 Before installation

 **Danger**

- Do not use damaged or missing components frequency inverter. Failure to comply will result in personal injury.
- Please use the electric motor with upper B insulation class. Failure to comply will result in personal injury.

1.1.2 During installation

 **Danger**

- Install the frequency inverter on incombustible objects such as metal, and keep it away from combustible materials. Failure to comply may result in a fire.

 **Warning**

- When two frequency inverters are laid in the same cabinet, arrange the installation positions properly to ensure the enough cooling effect.
- Do not drop wire residue or screw into the frequency inverter. Failure to comply will result in damage to the frequency inverter.

1.1.3 wiring

 **Danger**

- Wiring must be performed only by qualified personnel under instructions described in this manual. Failure to comply may result in unexpected accidents.
- A circuit breaker must be used to isolate the power supply and the frequency inverter. Failure to comply may result in a fire.
- Ensure that the power supply is cut off before wiring. Failure to comply may result in electric shock.
- Connect the frequency inverter to ground properly by standard. Failure to comply may result in electric shock.

 **Warning**

- Never connect the power supply cables to the output terminals (U, V, W) of the Frequency inverter. Failure to comply will result in damage to the frequency inverter.
- Make sure that all the connecting wires comply with the requirement of EMC and the safety standard in the region. Use wire sizes recommended in the manual. Failure to comply may result in accidents.
- Never connect the braking resistor between the DC bus terminals (P+) and (P-). Failure to comply may result in a fire.

1.1.4 Before power-on

 **Danger**

- Check that the following requirements comply with:
 - The voltage class of the power supply is consistent with the rated voltage class of the frequency inverter.
 - The input terminals (R, S, T) and output terminals (U, V, W) are properly connected.
 - No short-circuit exists in the peripheral circuit.
 - The wiring is fastened.
- Failure to comply will result in damage to frequency inverter.
- Cover the frequency inverter properly before power-on to prevent electric shock.

 **Warning**

- Do not perform the voltage resistance test on any part of the frequency inverter because such test has been done in the factory. Failure to comply will result in accidents.
- All peripheral devices must be connected properly under the instructions described in this manual. Failure to comply will result in accidents.

1.1.5 After power-on

 **Danger**

- Do not open the frequency inverter's cover after power-on to prevent from electric shock.
- Do not touch the frequency inverter with wet hand and its peripheral circuit to prevent from electric shock.
- Do not touch the terminals of the frequency inverter (including the control terminals). Failure to comply may result in electric shock.
- Do not touch the U, V, W terminal or motor connecting terminals when frequency inverter automatically does safety testing for the external high-voltage electrical circuit. Failure to comply may result in electric shock.

 **Warning**

- Note the danger during the rotary running of motor when check the parameters. Failure to comply will result in accidents.
- Do not change the factory default settings of the frequency inverter. Failure to comply will result in damage to the frequency inverter.

1.1.6 During operation



Danger

- Do not go close to the equipment when selected the restart function. Failure to comply may result in personal injury.
- Do not touch the fan or the discharging resistor to check the temperature. Failure to comply will result in personal injury.
- Signal detection must be performed only by qualified personal during operation

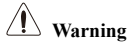

Warning

- Avoid objects falling into the frequency inverter when it is running. Failure to comply will result in damage to frequency inverter.
- Do not start/stop the frequency inverter by turning the contactor ON/OFF. Failure to comply will result in damage to the frequency inverter.

1.1.7 Maintenance



Danger

- Do not repair or maintain the frequency inverter at power-on. Failure to comply will result in electric shock.
- Repair or maintain the frequency inverter only after the charge light on frequency inverter is powered off. This allows for the residual voltage in the capacitor to discharge to a safe value. Failure to comply will result in personal injury.
- Repair or maintenance of the frequency inverter may be performed only by qualified personnel. Failure to comply will result in personal injury or damage to the frequency inverter.

1.2 General Precautions

1.2.1 Motor insulation test

Perform the insulation test when the motor is used for the first time, or when it is reused after being stored for a long time, or in a regular check-up, in order to prevent the poor insulation of motor windings from damaging the frequency inverter. The motor must be disconnected from the frequency inverter during the insulation test. A 500-V mega-Ohm meter is recommended for the test. The insulation resistance must not be less than 5 MΩ.

1.2.2 Thermal protection of motor

If the rated capacity of the motor selected does not match that of the frequency inverter, especially when the frequency inverter's rated power is greater than the motor's, adjust the motor protection parameters on the operation panel of the frequency inverter or install a thermal relay in the motor circuit for protection.

1.2.3 Running at over 50 Hz

The frequency inverter provides frequency output of 0 to 3000 Hz (Up to 300 Hz is supported if the frequency inverter runs in VC and SVC mode). If the frequency inverter is required to run at over 50 Hz, consider the bearable capacity of the machine.

1.2.4 Vibration of mechanical device

The frequency inverter may encounter the mechanical resonance point at some output frequencies, which can be avoided by setting the skip frequency.

1.2.5 Motor heat and noise

The output of the frequency inverter is pulse width modulation (PWM) wave with certain harmonic frequencies, and therefore, the motor temperature, noise, and vibration are slightly greater than those motor runs at grid power frequency (50 Hz).

1.2.6 Voltage-sensitive device or capacitor at output side of the Frequency inverter

Do not install the capacitor for improving power factor or lightning protection voltage-sensitive resistor at the output side of the frequency inverter because the output of the frequency inverter is PWM wave. Otherwise, the frequency inverter may suffer transient over current and even to be damaged.

1.2.7 Contactor at the Input/Output side of the frequency inverter

When a contactor is installed between the input side of the frequency inverter and the power supply, the frequency inverter must not be started or stopped by switching the contactor on or off. If the frequency inverter has to be operated by the contactor, ensure that the time interval between switching is at least one hour. Since frequently charge and discharge will shorten the service life of the capacitor inside of frequency inverter.

When a contactor is installed between the output side of the frequency inverter and the motor, do not turn off the contactor when the frequency inverter is active. Otherwise, IGBT modules inside of frequency inverter may be damaged.

1.2.8 When input voltage is over rated voltage range

The frequency inverter must not be used over the allowable voltage range specified in this manual. Otherwise, the frequency inverter's components may be damaged. If required, use a corresponding voltage transformer device.

1.2.9 Prohibition of three-phase input changed into two-phase input

Do not change the three-phase input of the frequency inverter to two-phase input. Otherwise, a fault will be result or the frequency inverter will be damaged.

1.2.10 Surge suppressor

The frequency inverter has a built-in voltage dependent resistor (VDR) for suppressing the surge voltage. For frequently surge place, please add extra surge voltage protection device at input side of frequency inverter.

Note: Do not connect the surge suppressor at the output side of the AC.

1.2.11 Altitude and de-rating

In places where the altitude is above 1000 m and the cooling effect reduces due to thin air, it is necessary to de-rate the frequency inverter. Please contact our company for technical support.

1.2.12 Some special usages

If wiring that is not described in this manual such as common DC bus is applied, please contact the agent or our company for technical support.

1.2.13 Disposal

The electrolytic capacitors on the main circuits and PCB may explode when they are burnt. Poisonous gas is generated when the plastic parts are burnt. Please treat them as industrial waste.

1.2.14 Adaptable Motor

The standard adaptable motor is adaptable four-pole squirrel-cage asynchronous induction motor. For other types of motor, select a proper frequency inverter according to the rated motor current. If user uses inverter for permanent magnet synchronous motor, please contact my company for technical support.

The cooling fan and rotor shaft of non-variable-frequency motor are coaxial, which results in reduced cooling effect when the rotational speed decreasing. If variable speed is required, add a more powerful fan or replace it with variable-frequency motor in applications where the motor overheats easily.

The standard parameters of the adaptable motor have been configured inside the frequency inverter. It is still necessary to perform motor auto-tuning or modify the default values based on actual conditions. Otherwise, the running result and protection performance will be affected.

The frequency inverter may alarm or even be damaged when short-circuit exists on cables or inside the motor. Therefore, perform insulation short-circuit test when the motor and cables are newly installed or during routine maintenance. During the test, make sure that the frequency inverter is disconnected from the tested parts.

2. Product Information

2.1 Designation Rules

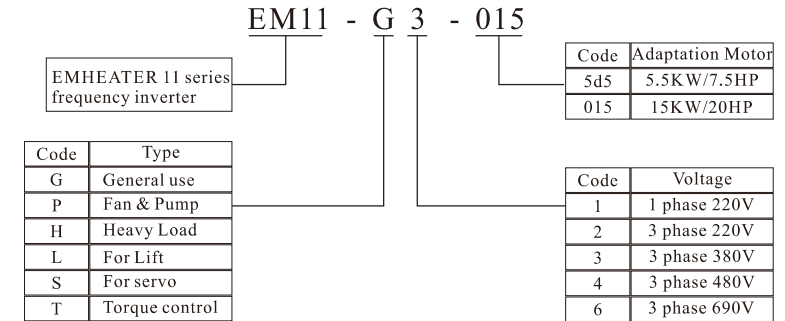

Diagram 2-1 Designation rules

2.2 Nameplate

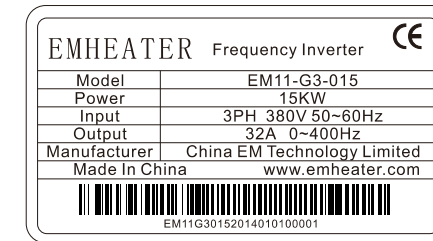

Diagram 2-2 Nameplate

2.3 EM11 Series Frequency Inverter

Table 2-1 Models and technical data of EM11

Model	Adaptable Motor		Input	Output	Power Capacity (KVA)	Thermal Power Consumption (KW)
	KW	HP	Current (A)	Current (A)		
Single-phase 220V , 50/60Hz						
EM11-G1-d75	0.75	1.0	8.2	4	1.5	0.030
EM11- G1-1d5	1.5	2.0	14	7	3.0	0.055
EM11- G1-2d2	2.2	3.0	23	9.6	4.0	0.072
Three-phase 220V , 50/60Hz						
EM11-G2-d75	0.75	1	5	3.8	3	0.030
EM11- G2-1d5	1.5	2	5.8	5.1	4	0.055
EM11- G2-2d2	2.2	3	10.5	9	5.9	0.072

Model	Adaptable Motor		Input Current (A)	Output Current (A)	Power Capacity (KVA)	Thermal Power Consumption (KW)	
	KW	HP					
EM11- G2-004	3.7	5	14.6	13	8.9	0.132	
EM11- G2-5d5	5.5	7.5	26	25	17	0.214	
EM11- G2-7d5	7.5	10	35	32	21	0.288	
EM11- G2-011	11	15	46.5	45	30	0.489	
EM11- G2-015	15	20	62	60	40	0.608	
EM11- G2-018	18.5	25	76	75	57	0.716	
EM11- G2-022	22	30	92	91	69	0.887	
EM11- G2-030	30	40	113	112	85	1.11	
EM11- G2-037	37	50	157	150	114	1.32	
EM11- G2-045	45	60	180	176	134	1.66	
EM11- G2-055	55	75	214	210	160	1.98	
EM11- G2-075	75	100	307	304	231	2.02	
Three-phase 380V , 50/60Hz							
EM11- G3-d75	0.75	1	3.4	2.1	1.5	0.027	
EM11- G3-1d5	EM11- P3-1d5	1.5	2	5	3.8	3	0.050
EM11- G3-2d2	EM11- P3-2d2	2.2	3	5.8	5.1	4	0.066
EM11- G3-004	EM11- P3-004	3.7	5	10.5	9	5.9	0.120
EM11- G3-5d5	EM11- P3-5d5	5.5	7.5	14.6	13	8.9	0.195
EM11- G3-7d5	EM11- P3-7d5	7.5	10	20.5	17	11	0.262
EM11- G3-011	EM11- P3-011	11	15	26	25	17	0.445
EM11- G3-015	EM11- P3-015	15	20	35	32	21	0.553
EM11- G3-018	EM11- P3-018	18.5	25	38.5	37	24	0.651
EM11- G3-022	EM11- P3-022	22	30	46.5	45	30	0.807
EM11- G3-030	EM11- P3-030	30	40	62	60	40	1.01
EM11- G3-037	EM11- P3-037	37	50	76	75	57	1.20
EM11- G3-045	EM11- P3-045	45	60	92	91	69	1.51
EM11- G3-055	EM11- P3-055	55	75	113	112	85	1.80
EM11- G3-075	EM11- P3-075	75	100	157	150	114	1.84
EM11- G3-090	EM11- P3-090	90	125	180	176	134	2.08
EM11- G3-110	EM11- P3-110	110	150	214	210	160	2.55
EM11- G3-132	EM11- P3-132	132	200	256	253	192	3.06
EM11- G3-160	EM11- P3-160	160	250	307	304	231	3.61
EM11- G3-200	EM11- P3-200	200	300	385	377	250	4.42
EM11- G3-220	EM11- P3-220	220	300	430	426	280	4.87
EM11- G3-250	EM11- P3-250	250	400	468	465	355	5.51
EM11- G3-280	EM11- P3-280	280	370	525	520	396	6.21
EM11- G3-315	EM11- P3-315	315	500	590	585	445	7.03
EM11- G3-355	EM11- P3-355	355	420	665	650	500	7.81
EM11- G3-400	EM11- P3-400	400	530	785	725	565	8.51
	EM11- P3-450	450	600	883	820	630	9.23

2.4 Technical Specifications

Table 2-2 Technical specifications of EM11

Item	Specifications	
Standard functions	Maximum frequency	Vector control: 0~300 Hz V/F control: 0~3000 Hz
	Carrier frequency	0.5~16 kHz (The carrier frequency is automatically adjusted based on the load features.)
	Input frequency resolution	Digital setting: 0.01 Hz Analog setting: maximum frequency x 0.025%
	Control mode	Sensor-less vector control (SVC) Closed-loop vector control (VC) (+ PG card) Voltage/Frequency (V/F) control
	Startup torque	G type: 0.5 Hz/150% (SVC); 0 Hz/180% (VC) P type: 0.5 Hz/100%
	Speed range	1:100 (SVC) Speed range
	Speed stability accuracy	± 0.5% (SVC) ± 0.02% (VC)
	Torque control accuracy	± 5% (VC)
	Overload capacity	G type: 60s for 150% of the rated current, 3s for 180% of the rated current P type: 60s for 120% of the rated current, 3s for 150% of the rated current
	Torque boost	Auto boost Manual boost 0.1%~30.0%
	V/F curve	Straight-line V/F curve Multi-point V/F curve N-power V/F curve (1.2-power, 1.4-power, 1.6-power, 1.8-power, square)
	V/F separation	Two types: complete separation; half separation
	Acceleration/deceleration curve	Straight-line ramp S-curve ramp Four groups of acceleration/deceleration time with the range of 0.0s~65000s
	DC braking	DC braking frequency: 0.00 Hz ~ maximum frequency Braking time: 0.0s~36.0s Braking trigger current value: 0.0%~100.0%
	Standard functions	JOG control
Built-in simple PLC, multiple speeds		It realizes up to 16 speeds via the simple PLC function or combination of DI terminal states.
Built-in PID		It realizes closed loop control system easily.
Auto voltage regulation (AVR)		It can keep constant output voltage automatically when the mains voltage fluctuation.

Item		Specifications
	Overvoltage/ Over current stall control	The current and voltage are limited automatically during the running process so as to avoid frequently tripping due to overvoltage / over current.
	Rapid current limit function	It can auto limit running current of frequency inverter to avoid frequently tripping.
	Torque limit and control	(Excavator characteristics) It can limit the torque automatically and prevent frequently over current tripping during the running process. Torque control can be implemented in the VC mode.
Individualized functions	High performance	Control of asynchronous motor and synchronous motor are implemented through the high-performance current vector control technology.
	Instant power off not stop	The load feedback energy compensates the voltage reduction so that the frequency inverter can continue to run for a short time.
	Rapid current limit	To avoid frequently over current faults of the frequency inverter.
	Virtual I/O	Five groups of virtual DI/DO can realize simple logic control.
	Timing control	Time range: 0.0~6500.0 minutes
	Multi-motor switchover	Two motors can be switched by two groups of motor parameters.
	Multiple communication protocols	It supports communication bus via Modbus-RTU, PROFIBUS-DP, CANlink and CANopen.
	Motor overheat protection	The optional I/O extension card enables AI3 to receive the motor temperature sensor input (PT100, PT1000) so as to realize motor overheat protection.
RUN	Multiple encoder types	It supports various encoders such as differential encoder, open-collector encoder, resolver, UVW encoder, and SIN/COS encoder.
	Advanced background software	It supports the operation of frequency inverter parameters and virtual oscillograph function, by which the state of frequency inverter can be monitored.
RUN	Running command giving	key panel Control terminals Serial communication port You can switch between these giving in various ways.
RUN	Frequency giving	There are 10 kinds frequency giving: digital setting, analog voltage setting, analog current setting, pulse setting and serial communication port setting. You can switch between these giving in various ways.
	Auxiliary frequency giving	There are 10 kinds auxiliary frequency giving. It can implement tiny tuning of auxiliary frequency and frequency synthesis.

Item		Specifications
RUN	Input terminal	Standard: 6 digital input (DI) terminals, one of which supports up to 50 kHz high-speed pulse input 2 analog input (AI) terminals, one of which only supports 0V~10 V voltage input and the another supports 0V~10 V voltage input or 0~20 mA current input expanding capacity: many DI terminals 1 AI terminal that supports -10V~10 V voltage input.
	Output terminal	Standard 1 high-speed pulse output terminal (open-collector) that supports 0~50 kHz square wave signal output. 1 digital output (DO) terminal. 1 relay output terminal. 2 analog output (AO) terminals, one of them supports 0~20 mA current output or 0V~10 V voltage output expanding capacity: many DO terminals. many relay output terminals.
Display and keypad operation	LED display	It displays the parameters.
	LCD display	It is optional, supports panel display in Chinese or English language.
	Parameters copy	Optional LCD keypad can copy parameters.
	Key locking and function selection	It can lock the keys partially or completely and define the function range of some keys so as to prevent misoperation.
	Protection mode	Motor short-circuit detection at power-on, input/output phase loss protection, over current protection, overvoltage protection, less voltage protection, overheat protection and overload protection,etc.
Environment	Installation location	Indoor, no direct sunlight, dust, corrosive gas, combustible gas, oil smoke, vapour, drip or salt.
	Altitude	Lower than 1000 m
	Ambient temperature	-10°C~ +40°C (de-rated if the ambient temperature is between 40°C and 50°C)
	Humidity	Less than 95%RH, without condensing
	Vibration	Less than 5.9 m/s ² (0.6 g)
Storage temperature	-20°C ~ +60°C	

2.5 Product appearance and installation dimension

2.5.1 Product appearance

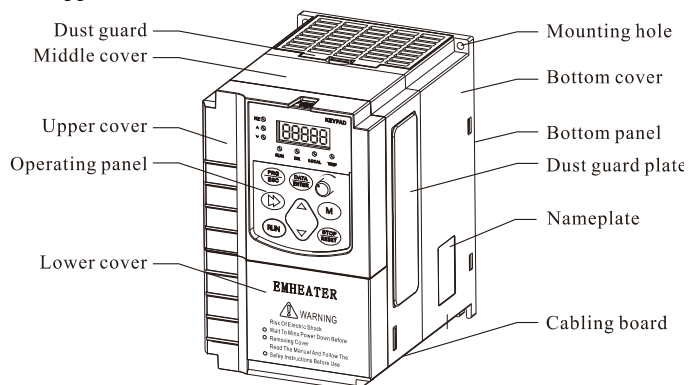

Diagram 2-3 Product appearance

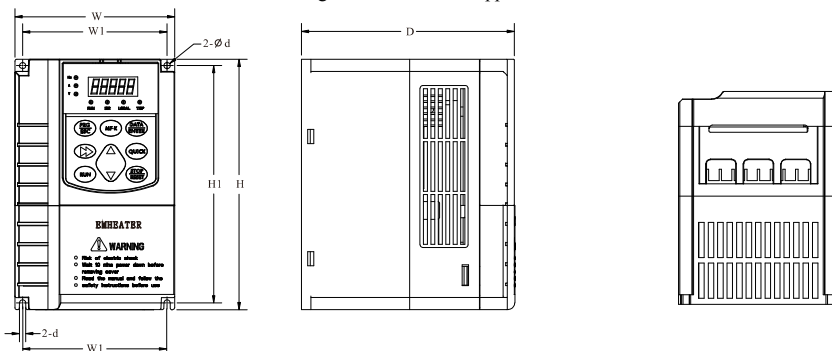

Diagram 2-4 Appearance and installation dimension of EM11 series (Plastic housing structure)

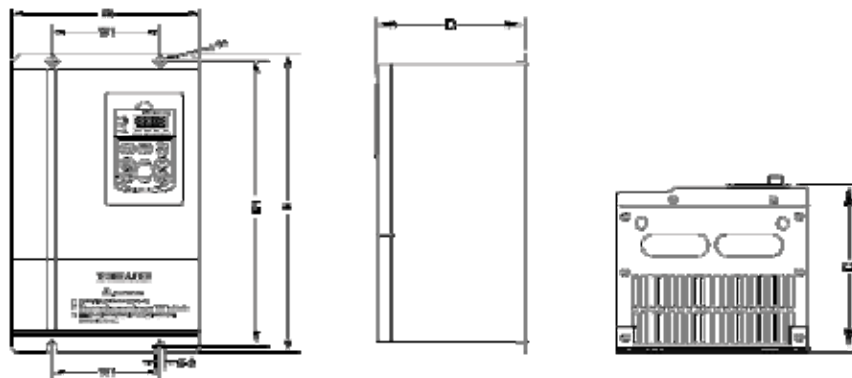

Diagram 2-5 Appearance and installation dimension of EM11 series (Metal housing structure)

The housing types of the EM11 models are listed in the following table.

Voltage & Power	Housing Type
Single-phase 220 V	
0.4–2.2 kW	Plastic housing
Three-phase 220 V	
0.4–4 kW	Plastic housing
5.5–75 kW	Sheet metal housing
Three-phase 380 V	
0.75–7.5 kW	Plastic housing
11–400 kW	Sheet metal housing

2.5.2 Appearance and Installation Hole Dimension (mm) of EM11 Frequency Inverter

Table 2-3 Appearance and installation hole dimension (mm) of EM11 frequency inverter

Model	Appearance and installing dimension (mm)					
	W	W1	H	H1	D	Φd
Single-phase 220V						
EM11-G1-d75						
EM11- G1-1d5						
EM11- G1-2d2						
Three-phase 220V						
EM11-G2-d75						
EM11- G2-1d5						
EM11- G2-2d2	160	148	247	235	177	Φ5.5
EM11- G2-004	220	126	349	334	194	Φ7
EM11- G2-5d5	290	230	455	440	218	Φ7
EM11- G2-011	320	230	555	540	240	Φ10
EM11- G2-015	410	320	635	610	239	Φ12
EM11- G2-018	460	320	654	630	340	Φ12
EM11- G2-022	560	420	847	820	348	Φ14
EM11- G2-030						
EM11- G2-037						
EM11- G2-045						
EM11- G2-055						
EM11- G2-075						
Three-phase 380V						
EM11- G3-d75/P3-1d5						
EM11- G3-1d5/P3-2d2	118	106.5	185	175.5	157	Φ4.5
EM11- G3-2d2/P3-004						
EM11- G3-004/P3-5d5	160	148	247	235	177	Φ5.5
EM11- G3-5d5/P3-7d5	220	126	349	334	194	Φ7
EM11- G3-7d5/P3-011						
EM11- G3-011/P3-015						
EM11- G3-015/P3-018						

Model	Appearance and installing dimension (mm)					
	W	W1	H	H1	D	Φd
EM11- G3-018/P3-022	290	230	455	440	218	Φ7
EM11- G3-022/P3-030						
EM11- G3-030/P3-037						
EM11- G3-037/P3-045	320	230	555	540	240	Φ10
EM11- G3-045/P3-055						
EM11- G3-055/P3-075	410	320	635	610	239	Φ12
EM11- G3-075/P3-090						
EM11- G3-090/P3-110						
EM11- G3-110/P3-132	460	320	654	630	340	Φ12
EM11- G3-132/P3-160						
EM11- G3-160/P3-200						
EM11- G3-200/P3-220	560	420	847	820	348	Φ14
EM11- G3-220/P3-250						
EM11- G3-250/P3-280						
EM11- G3-280/P3-315	700	520	956	920	368	Φ14
EM11- G3-315/P3-355						
EM11- G3-355/P3-400						
EM11- G3-400/P3-450	800	620	1232	1200	378	Φ18

2.5.3 Appearance and installation dimension of external keypad (keypad tray)

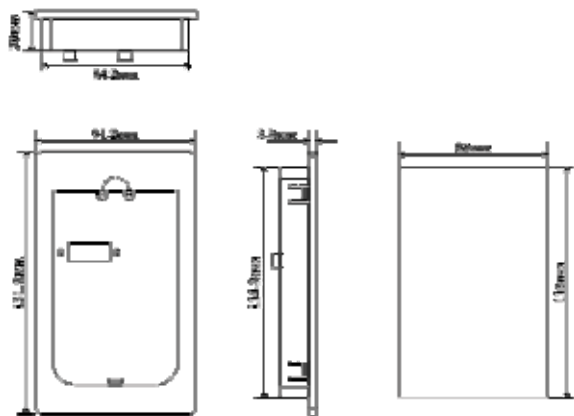

Diagram 2-6 Appearance and installation dimension of external keypad (keypad tray)

2.6 Options

Please indicate if the following options are needed when placing order.

Table 2-4 Options of EM11 frequency inverter

Item	Model	Functions	Remarks
Internal braking unit	With "-B" after the product model	Single-phase: 0.4kw~2.2kw; Three-phase: 0.75kw~15kw, Standard built-in brake unit	The internal braking unit is optional for 18.5kw~75kw.
External braking unit		External braking unit for above 75kw(including 75kw)	
Energy-regeneration unit		Energy saving product makes the electric energy of frequency inverter feedback to the AC power grid.	
Rectifying unit		To use the unit when many frequency inverters use the one DC bus, the way can save energy.	

2.7 Daily maintenance of frequency inverters

2.7.1 Daily maintenance

Due to the influence of temperature, humidity, dust and vibration, it will lead to poor heat dissipation and component aging of frequency inverter, and results in potential failure or reducing the service life of frequency inverter. Therefore, it is necessary to do daily and regular maintenance of the frequency inverter.

Daily check items:

1. Check if the sound is normal during the running of the motor;
2. Check if there is a vibration during the running of the motor;
3. Check whether the installation environment of frequency inverter has changed;
4. Check if the cooling fan of frequency inverter is working correctly, the cooling air duct is clear;
5. Check if the frequency inverter is overheating;
6. Make sure that the frequency inverter should always be kept in a clean state;
7. Clear up effectively the dust on the surface of the frequency inverter, prevent the dust from entering into the inside of the frequency inverter, especially for the metal dust;
8. Clear up effectively the oil and dust on the cooling fan of frequency inverter.

2.7.2 Regular inspection

Please regularly check frequency inverter, especially for the difficult checking place of running.

Regular inspection items:

1. Check the air duct and clear up regularly;
2. Check if there are any loose screws;
3. Check if the inverter has been corroded;
4. To do insulation test for the main circuit;
5. Check if the terminals have arcing mark.

Note: When using the megger (please use the DC 500V meg ohm meter) to measure the insulation resistance, you shall disconnect the main circuit to the frequency inverter. Do not use the insulation resistance meter to test the control circuit. Do not to do the high voltage test (It has been done when the frequency inverter producing in factory.)

2.7.3 Wearing parts replacement

The wearing parts of frequency inverter include the cooling fan and filtering electrolytic capacitor, its service life is closely related to the using environment and maintenance status. The general service life is:

Part Name	Service Life
Fan	3 to 4 Years
Electrolytic capacitor	5 to 6 Years

The user can confirm the replace time according to the running time.

- Possible reasons for the damage of cooling fan: bearing wear and blade aging. Distinguish standard: Any cracks in the fan blade, any abnormal vibration sound during the starting of frequency inverter.
- Possible reasons for the damage of filtering electrolytic capacitor: poor quality of the input power supply, the environment temperature is higher, the load change frequently and the electrolyte aging. Distinguish standard: Any leakage of its liquid, if the safety valve is protruding, electrostatic capacitance and insulation resistance measurement.

2.7.4 Storage of the frequency inverter

After buying the frequency inverter, users shall pay attention to the temporary and long-term storage as following:

- Store the frequency inverter in the original packaging;
- Long-term storage can lead to the degradation of electrolytic capacitors, and must ensure to power on for once within 2 years. And the power-on time is at least 5 hours. The input voltage must slowly rise to the rating by using the voltage regulator.

2.8 Warranty Items

- Warranty only refers to frequency inverter.
- Under normal use, if there is any failure or damage, our company is responsible for the warranty within 12 months. (Leave factory date is subjected to the S/N on the frequency inverter nameplate or the contract). When over 12 months, reasonable maintenance fee will be charged;
- During 12 months, if the following situation happens, certain maintenance fee will be charged;
 - The users don't follow the manual stated makes the frequency inverter damaged;
 - The damage caused by fire, flood and abnormal voltage;
 - The damage caused by using the frequency inverter for abnormal functions;
 - The relevant service fee is calculated according to the manufacturer's standard, if there is contract, then it carries out subject to the contract.

2.9 Selection Guide of braking component

Table 2-5 is the recommended value of braking resistor, users can select the different resistance value and power according to the actual situation, (but the resistance value must not be less than the recommended value in the table, and the power can be bigger.) The selection of braking resistance need to be confirmed according to the power that the motor generated in the practical application systems, and is relevant to the system inertia, deceleration time, the energy of the potential energy load, needs customers to choose according to actual situation. The greater the inertia the shorter deceleration time is needed and more frequently braking, so the braking resistor needs the one with bigger power but smaller resistance value.

2.9.1 Selection of braking resistance value

When braking, almost all the renewable energy of motor is consumed on the braking resistor.

According to the formula: $U * U/R = P_b$

In the formula:

U --- The braking voltage when the system brake stably (different system is different, for the 380VAC system generally take 700V)

R - Braking resistor

P_b – Power of braking

2.9.2 Selection power of braking resistor

In theory the power of braking resistor is consistent with the braking power, but it need to be taken into consideration that the braking resistor power will derate to 70%.

According to the formula: $0.7 * P_r = P_b * D$

In this formula:

P_r --- Power of resistor

D --- Braking proportion (the proportion that the regeneration process accounts for the whole process)

Elevator --- 20%~30%

Uncoiling and coiling machine --- 20%~30%

Centrifugal machine --- 50%~60%

Occasionally braking load --- 5%

Other machine generally --- 10%

Table 2-5 EM11 Inverter braking components selection table

Model	Recommend power of braking resistor	Recommend resistance value of braking resistor	Braking unit	Remarks
Single-phase 220V				
EM11-G1-d75	80W	$\geq 150\Omega$		
EM11- G1-1d5	100W	$\geq 100\Omega$		
EM11- G1-2d2	100W	$\geq 70\Omega$		
Three-phase 220V				
EM11-G2-d75	150W	$\geq 110\Omega$		
EM11- G2-1d5	250W	$\geq 100\Omega$		
EM11- G2-2d2	300W	$\geq 65\Omega$		
EM11- G2-004	400W	$\geq 45\Omega$		
EM11- G2-5d5	800W	$\geq 22\Omega$		
EM11- G2-7d5	1000W	$\geq 16\Omega$		
EM11- G2-011	1500W	$\geq 11\Omega$		
EM11- G2-015	2500W	$\geq 8\Omega$		
EM11- G2-018	3.7 kW	$\geq 8.0\Omega$	Built-in as option	Add "-B" to the model
EM11- G2-022	4.5 kW	$\geq 8\Omega$		
EM11- G2-030	5.5 kW	$\geq 4\Omega$		
EM11- G2-037	7.5 kW	$\geq 4\Omega$		
EM11- G2-045	4.5 kW×2	$\geq 4\Omega \times 2$	External	
EM11- G2-055	5.5 kW×2	$\geq 4\Omega \times 2$	External	

Model	Recommend power of braking resistor	Recommend resistance value of braking resistor	Braking unit	Remarks
EM11- G2-075	16k W	$\geq 1.2\Omega$	External	
Three-phase 380V				
EM11- G3-d75/P3-1d5	150W	$\geq 300\Omega$	Built-in as standard	No special instructions
EM11- G3-1d5/P3-2d2	150W	$\geq 220\Omega$		
EM11- G3-2d2/P3-004	250W	$\geq 200\Omega$		
EM11- G3-004/P3-5d5	300W	$\geq 130\Omega$		
EM11- G3-5d5/P3-7d5	400W	$\geq 90\Omega$		
EM11- G3-7d5/P3-011	500W	$\geq 65\Omega$		
EM11- G3-011/P3-015	800W	$\geq 43\Omega$		
EM11- G3-015/P3-018	1000W	$\geq 32\Omega$		
EM11- G3-018/P3-022	1300W	$\geq 25\Omega$	Built-in as option	Add "-B" to the model
EM11- G3-022/P3-030	1500W	$\geq 22\Omega$		
EM11- G3-030/P3-037	2500W	$\geq 16\Omega$		
EM11- G3-037/P3-045	3.7 kW	$\geq 16.0\Omega$	Built-in as option	Add "-B" to the model
EM11- G3-045/P3-055	4.5 kW	$\geq 16\Omega$		
EM11- G3-055/P3-075	5.5 kW	$\geq 8\Omega$		
EM11- G3-075/P3-090	7.5 kW	$\geq 8\Omega$	External	EM-BU3
EM11- G3-090/P3-110	4.5 kW×2	$\geq 8\Omega \times 2$		
EM11- G3-110/P3-132	5.5 kW×2	$\geq 8\Omega \times 2$	External	EM-BU3H
EM11- G3-132/P3-160	6.5 kW×2	$\geq 8\Omega \times 2$		
EM11- G3-160/P3-200	16kW	$\geq 2.5\Omega$	External	EM-BU4H
EM11- G3-200/P3-220	20 kW	$\geq 2.5\Omega$		
EM11- G3-220/P3-250	22 kW	$\geq 2.5\Omega$	External	EM-BU5H
EM11- G3-250/P3-280	12.5 kW×2	$\geq 2.5\Omega \times 2$		
EM11- G3-280/P3-315	14 kW×2	$\geq 2.5\Omega \times 2$	External	EM-BU4H*2
EM11- G3-315/P3-355	16 kW×2	$\geq 2.5\Omega \times 2$		
EM11- G3-355/P3-400	17 kW×2	$\geq 2.5\Omega \times 2$	External	EM-BU4H*2
EM11- G3-400/P3-450	14 kW×3	$\geq 2.5\Omega \times 3$		

2.9.3 Braking resistor connection description

The braking resistor connection of EM11 series frequency inverter is showed as below:

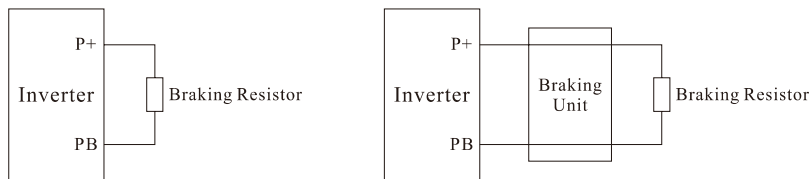

Diagram 2-7 Braking resistor connection scheme

3. Installation of Frequency Inverter

3.1 Installation environment

1. The place with indoor vents or ventilation devices.
2. The environment temperature shall be $-10 \sim 40$. If the temperature is over 40 but less than 50 , better to take down the cover of frequency inverter or open the front door of cabinet to facilitate heat dissipation.
3. Try to avoid high temperature and wet place; the humidity shall be less than 90% without frost deposit.
4. Avoid direct sunlight.
5. Keep away from flammable, explosive and corrosive gas and liquid.
6. No dust, floating fiber and metal particles.
7. Install on the place without strongly vibration. And the vibration should be not over 0.6G, Especially pay attention to far away from the punching machine, etc.
8. Keep away from electromagnetic interference source.

3.2 Installation direction and space

In order to not affect the service life of frequency inverter and reduce its performance, note for its installation direction and space and correctly fasten it.

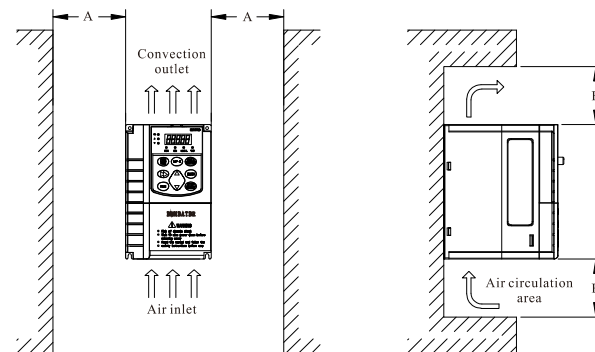

Diagram 3-1 Ventilating duct installation dimension diagram of frequency inverter

Power class	Installation dimension	
	A	B
$\leq 7.5\text{kW}$	$\geq 20\text{mm}$	$\geq 100\text{mm}$
11kW - 30kW	$\geq 50\text{mm}$	$\geq 200\text{mm}$
$\geq 37\text{kW}$	$\geq 50\text{mm}$	$\geq 300\text{mm}$

Please install the frequency inverter vertically, to send out the heat upward, and pay attention to direction of frequency inverter to avoid inversion.

If there are several units of frequency inverter installed, please install them side by side, do not to install up and down.

3.3 Peripheral Devices Connection Diagram

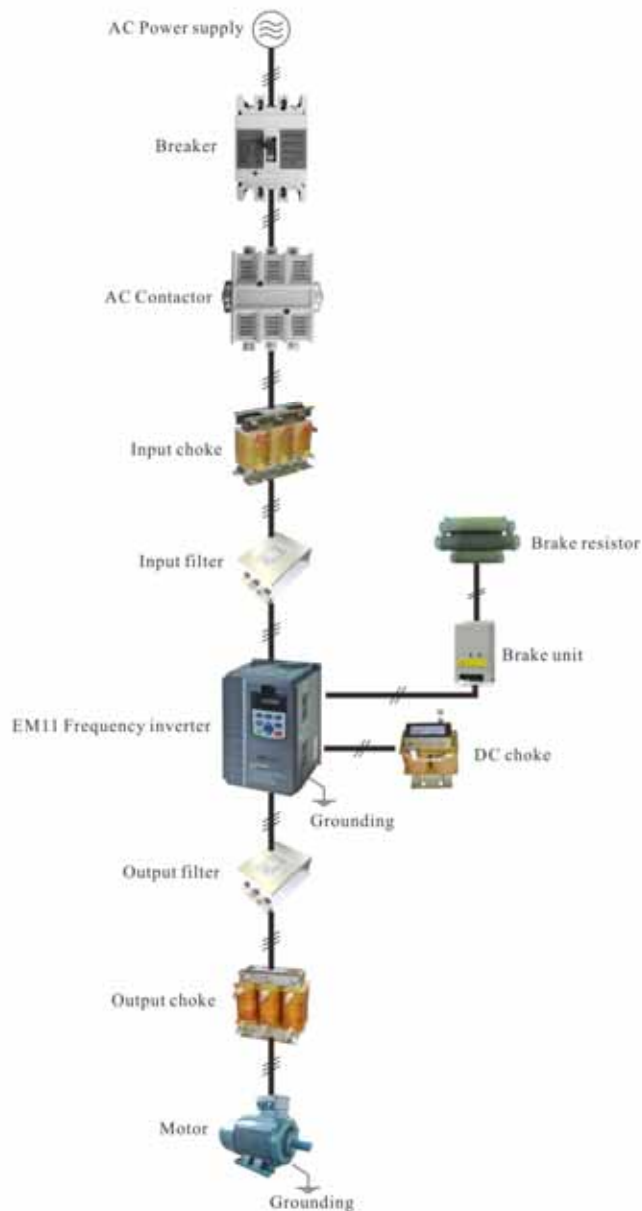

Diagram 3-2 Peripheral Devices Connection

3.4 Instructions of Main Circuit Peripheral Devices

Table 3-1 Main circuit peripheral devices use instructions

Parts Name	Installation Location	Function Description
MCCB	Front of input circuit	The capacity of the circuit breaker shall be 1.5 to 2 times of the rated current of the inverter. The protect time of the circuit breaker shall fully consider the time features of the inverter overload protection.
Residual-current circuit breaker(RCCB)	Front of input circuit	As the inverter output is the high-frequency pulse output, there will be high-frequency leakage current. Special leakage circuit breaker shall be used when installing leakage circuit breaker at the input side of the inverter. It is suggested that B type leakage circuit breaker be used, and the leakage current value shall be set as 300mA.
Contactor	Between MCCB and frequency inverter input side	Frequently open and close of contactor will cause inverter failure, so the highest frequency for opening and closing of contactor shall be not exceeded than 10 times/min when braking resistor is used, to avoid the over-hot damage of the braking resistor, thermal protection relay with braking resistor over-hot detection shall be installed, by terminal of the thermal protection relay to disconnect the contactor.
Input AC reactor or DC reactor	Frequency inverter input side / near the frequency inverter	The inverter power supply capacity is more than 600kVA or 10 times of the inverter capacity. If there is switch type reactive-load compensation capacitor or load with silicon control at the same power node, there will be high peak current flowing into input power circuit, causing the damage of the rectifier components. When the voltage unbalancedness of the three-phase power supply of the inverter exceeds 3%, the rectifier component will be damaged. It is required that the input power factor of the inverter shall be higher than 90%. When the above situations occurred, install the AC reactor at the input side of the inverter or DC reactor to the DC reactor terminal.
Input noise filter	The frequency inverter input side	To reduce the noise input from the power to the inverter or output from the inverter to the power.
Thermal protection relay	The output side of frequency inverter	Although the inverter has motor overload protection function, when one inverter drives two or more motors or multi-pole motors, to prevent the motor over-temperature failure, thermal protection relay shall be installed between the inverter and each motor.
Output filter	The output side of frequency inverter	When the output side of the inverter is connected with output filter, the conduction and radiation interference can be reduced.
Output AC reactor	Between the output side of frequency inverter and motor, near the frequency inverter	When the cable connecting the inverter and the motor is longer than 100meters, it is suggested to install AC output reactor to suppress the high-frequency oscillation to avoid the damage to motor insulation, large leakage current and frequent inverter protective action.

3.5 Model Selection of Main Circuit Peripheral Devices

Table 3-2 Model Selection Diagram of Main Circuit Peripheral Devices (Recommended)

Frequency inverter Model	MCCB (A)	Contactor (A)	Cable of Input Side Main Circuit (mm ²)	Cable of Output Side Main Circuit (mm ²)	Cable of Control Circuit (mm ²)
Single-phase 220V					
EM11-G1-d75	16	10	2.5	2.5	1.0
EM11-G1-1d5	20	16	4.0	2.5	1.0
EM11-G1-2d2	32	20	6.0	4.0	1.0
Three-phase 220V					
EM11-G2-d75	16	10	2.5	2.5	1.0
EM11-G2-1d5	16	10	2.5	2.5	1.0
EM11-G2-2d2	25	16	4.0	4.0	1.0
EM11-G2-004	32	25	4.0	4.0	1.0
EM11-G2-5d5	63	40	4.0	4.0	1.0
EM11-G2-7d5	63	40	6.0	6.0	1.0
EM11-G2-011	100	63	10	10	1.0
EM11-G2-015	125	100	16	10	1.0
EM11-G2-018	160	100	16	16	1.0
EM11-G2-022	200	125	25	25	1.0
EM11-G2-030	200	125	35	25	1.0
EM11-G2-037	250	160	50	35	1.0
EM11-G2-045	250	160	70	35	1.0
EM11-G2-055	350	350	120	120	1.0
EM11-G2-075	500	400	185	185	1.0
Three-phase 380V					
EM11-G3-d75/P3-1d5	10	10	2.5	2.5	1.0
EM11-G3-1d5/P3-2d2	16	10	2.5	2.5	1.0
EM11-G3-2d2/P3-004	16	10	2.5	2.5	1.0
EM11-G3-004/P3-5d5	25	16	4.0	4.0	1.0
EM11-G3-5d5/P3-7d5	32	25	4.0	4.0	1.0
EM11-G3-7d5/P3-011	40	32	4.0	4.0	1.0
EM11-G3-011/P3-015	63	40	4.0	4.0	1.0
EM11-G3-015/P3-018	63	40	6.0	6.0	1.0
EM11-G3-018/P3-022	100	63	6	6	1.0
EM11-G3-022/P3-030	100	63	10	10	1.0
EM11-G3-030/P3-037	125	100	16	10	1.0
EM11-G3-037/P3-045	160	100	16	16	1.0
EM11-G3-045/P3-055	200	125	25	25	1.0
EM11-G3-055/P3-075	250	125	35	25	1.0
EM11-G3-075/P3-090	250	160	50	35	1.0

Frequency inverter Model	MCCB (A)	Contactor (A)	Cable of Input Side Main Circuit (mm ²)	Cable of Output Side Main Circuit (mm ²)	Cable of Control Circuit (mm ²)
EM11-G3-090/P3-110	350	160	70	35	1.0
EM11-G3-110/P3-132	350	350	120	120	1.0
EM11-G3-132/P3-160	400	400	150	150	1.0
EM11-G3-160/P3-200	500	400	185	185	1.0
EM11-G3-200/P3-220	630	600	150*2	150*2	1.0
EM11-G3-220/P3-250	630	600	150*2	150*2	1.0
EM11-G3-250/P3-280	800	600	185*2	185*2	1.0
EM11-G3-280/P3-315	800	800	185*2	185*2	1.0
EM11-G3-315/P3-355	1000	800	150*3	150*3	1.0
EM11-G3-355/P3-400	1000	800	150*4	150*4	1.0
EM11-G3-400/P3-450	1200	1000	150*4	150*4	1.0

3.6 Removal and mounting of operating panel and cover

3.6.1 Removal and mounting of operating panel (keypad)

The operating panel of EM11 series Frequency inverter is a plug type, If you need to take it off when use or maintenance, please make sure the gentle actions, or it is easy to damage the plug type connection terminals on operating panel.

The removal and mounting of operating panel (keypad) is showed as Diagram3-3 and Diagram3-4:

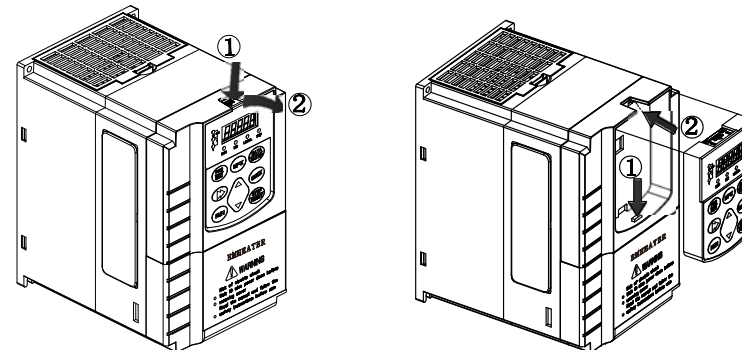

Diagram 3-3 Removal of operating panel (keypad) Diagram 3-4 Mounting of operating panel (keypad)

3.6.2 Removal and Mounting of Frequency Inverter

The EM11 series frequency inverter above 7.5kw (380V) uses plastic case. The removal and mounting of upper cover refers Diagram3-5. Please use tool to push the hooks on both side of lower cover.

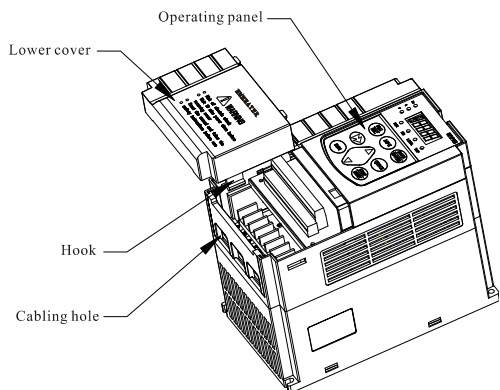

Diagram 3-5 The cover removal of plastic case

The EM11 series frequency inverter above 11kw (380V) uses metal case. The removal and mounting of lower cover refers figure3-6. Using thumb to unscrew and push lower cover and raise the cover.

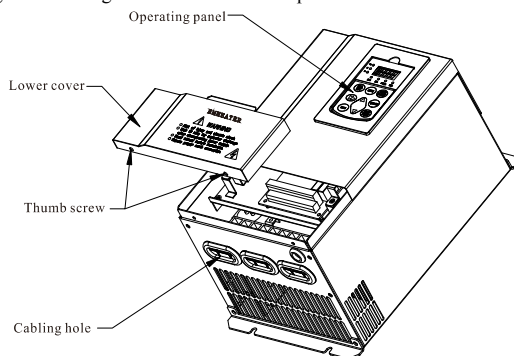

Diagram 3-6 EM11 series layout sketch

3.7 Connection Terminals Diagram Description

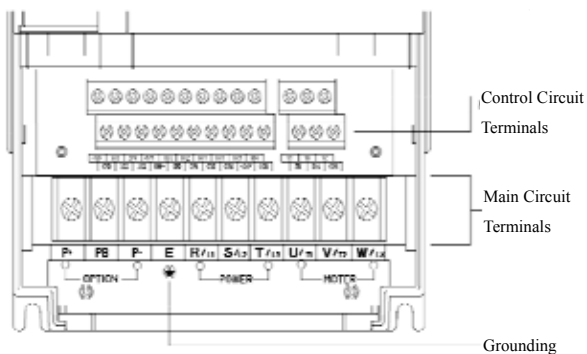

Diagram 3-7 EM11 Series terminal distribution diagram

3.8 Sketch and Description of Main Circuit Terminals

3.8.1 Function and description of Main Circuit Terminals

3.8.1.1 Main Circuit Terminals Sketch of single-phase 220V model

Including model: Single-phase 220V: EM11-G1-d75 ~ EM11-G1-2d2

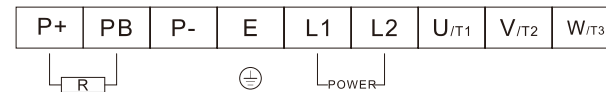

Terminal symbol	Function description
P+, PB	Connecting terminals of braking resistor
P+, P-	Input terminals of DC power
⊕/E	Grounding terminal
L1, L2	Single-phase AC power input terminals
U/T1, V/T2, W/T3	Three-phase AC power output terminals

3.8.1.2 Main Circuit Terminals Sketch of Three-phase 220V/380V Small Power Standard Models

Including model:

Three-phase 220V: EM11-G2-d75 ~ EM11-G2-7d5

Three-phase 380V: EM11-G3-d75/P3-1d5 ~ EM11-G3-015/P3-018



Terminal symbol	Function description
P+, PB	Connecting terminals of braking resistor
P+, P-	Input terminals of DC power
⊕/E	Grounding terminal
R/L1, S/L2, T/L3	Three-phase AC power input terminals
U/T1, V/T2, W/T3	Three-phase AC power output terminals

3.8.1.3 Main Circuit Terminals Sketch of Three-phase 220V/380V Middle and Big Power Standard Models

Including model:

Three-phase 220V: EM11-G2-011 ~ EM11-G2-075

Three-phase 380V: EM11-G3-018/P3-022 ~ EM11-G3-400/P3-450



Terminal symbol	Function description
R/L1, S/L2, T/L3	Three-phase AC power input terminals
P, P+	Connecting terminals of external DC reactor, Normally short circuited with copper bar.
P+, P-	DC power input terminals; DC output terminals of external braking unit
U/T1, V/T2, W/T3	Three-phase AC power output terminals
⊕/E	Grounding terminal

3.8.1.4 Main Circuit Terminals Sketch of Model with optional internal braking units

Including model:

Three-phase 220V: EM11-G2-011 ~ EM11-G2-037

Three-phase 380V: EM11-G3-018/P3-022 ~ EM11-G3-075/P3-090

R/L1	S/L2	T/L3	PB	P+	P-	E	U/T1	V/T2	W/T3
POWER			OPTION			⊕	MOTOR		

Terminal symbol	Function description
R/L1、 S/L2、 T/L3	Three-phase AC power input terminals
P+、 P-	DC power input terminals
P+、 PB	Braking resistor connecting
U/T1、 V/T2、 W/T3	Three-phase AC power output terminals
⊕ / E	Grounding terminal

Note: Product with standard built-in unit can realize DC bus and braking function at the same time, if external DC reactor and braking function is needed, please contact the manufacturer.

3.9 Cautions for Main Circuit Wiring

3.9.1 Power Supply Wiring

- It is forbidden to connect the power cable to the inverter output terminal, otherwise, the internal components of the inverter will be damaged.
- To facilitate the input side over current protection and maintenance after power off, the inverter shall connect to the power supply through the circuit breaker or leakage circuit breaker and contactor.
- Please confirm that the power supply phases, rated voltage are consistent with that of the nameplate, otherwise, the inverter may be damaged.

3.9.2 Motor Wiring

- It is forbidden to short circuit or ground the inverter output terminal, otherwise the internal components of the inverter will be damaged.
- Avoid short circuit the output cables or with the inverter enclosure, otherwise there exists the danger of electric shock.
- It is forbidden to connect the output terminal of the inverter to the capacitor or LC/RC noise filter with phase lead, otherwise, the internal components of the inverter may be damaged.
- When contactor is installed between the inverter and the motor, it is forbidden to switch on/off the contactor during the running of the inverter, otherwise, there will be large current flowing into the inverter, triggering the inverter protection action.
- Length of cable between the inverter and motor
- If the cable between the inverter and the motor is too long, the higher harmonic leakage current of the output end will produce by adverse impact on the inverter and the peripheral devices. It is suggested that when the motor cable is longer than 100m, output AC reactor be installed. Refer to the following table for the carrier frequency setting.

Length of cable between the inverter and motor	Carrier frequency (d6-00)
Less than 50m	Less than 15kHz
Less than 100 m	Less than 10kHz
More than 100m	Less than 5kHz

3.9.3 Grounding Wiring

- The inverter will produce leakage current. The higher the carrier frequency is, the larger the leakage current will be. The leakage current of the inverter system is more than 3.5mA, and the specific value of the leakage current is determined by the use conditions. To ensure the safety, the inverter and the motor must be grounded.
- The grounding resistance shall be less than 10ohm. For the grounding wire diameter requirement, refer to 2.6 electrotype of main circuit peripheral devices.
- Do not share grounding wire with the welding machine and other power equipment.
- In the applications with more than 2 inverters, keep the grounding wire from forming a loop.

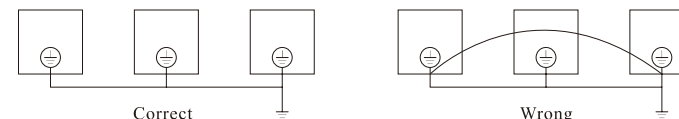

Diagram 3-8 Grounding Wire Connection Sketch Map

3.9.4 Countermeasures for Conduction and Radiation Interference

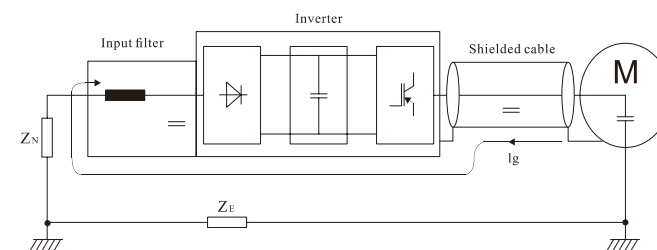

Diagram 3-9 Connection of conduction and radiation interference solutions

- When the input noise filter is installed, the wire connecting the filter to the inverter input power end shall be as short as possible.
- The filter enclosure and mounting cabinet shall be reliably grounded in large area to reduce the back flow impedance of the noise current I_g .
- The wire connecting the inverter and the motor shall be as short as possible. The motor cable adopts 4-core cable, with the grounding end grounded at the inverter side, the other end connected to the motor enclosure. The motor cable shall be sleeved into the metal tube.
- The input power wire and output motor wire shall be kept away from each other as far as possible.
- The equipment and signal cables vulnerable to influence shall be kept far away from the inverter.
- Key signal cables shall adopt shielding cable. It is suggested that the shielding layer shall be grounded with 360-degree grounding method and sleeved into the metal tube. The signal cable shall be kept far away from the inverter input wire and output motor wire. If the signal cable must cross the input wire and output motor wire, they shall be kept orthogonal.
- When analog voltage and current signals are adopted for remote frequency setting, twinning shielding cable shall be used. The shielding layer shall be connected to the grounding terminal PE of the inverter, and the signal cable shall be no longer than 50m.
- The wires of the control circuit terminals RA/RB/RC and other control circuit terminals shall be separately routed.

- It is forbidden to short circuit the shielding layer and other signal cables and the equipment.
- When the inverter is connected to the inductive load equipment (e.g. electromagnetic contactor, relay and solenoid valve), surge suppressor must be installed on the load equipment coil, as showed in Diagram 3-10

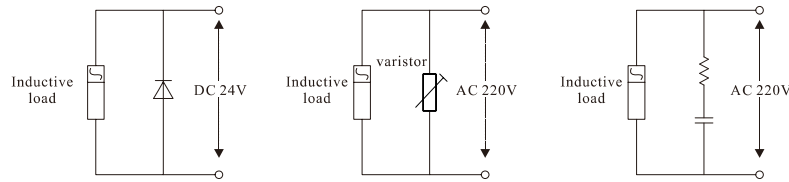

Diagram 3-10 Application example of inductive load surge suppressor

3.10 Control Circuit and Main Circuit Terminals Description

3.10.1 Control Circuit and Main Circuit Wiring

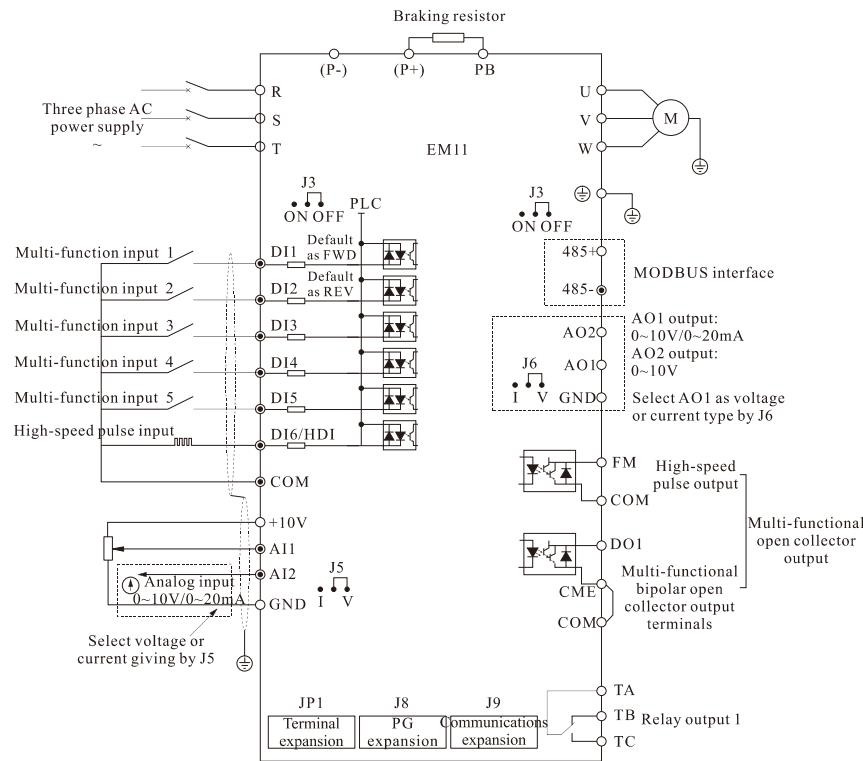

Diagram 3-11 Control Circuit and Main Circuit Wiring

3.10.2 Control Circuit Terminal Layout

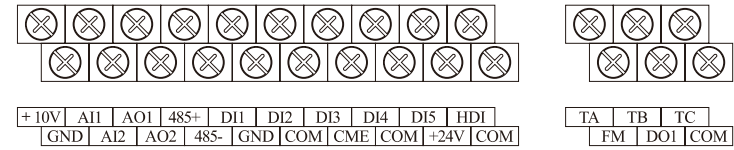

Diagram 3-12 EM11 Control Circuit Terminal Sketch Map

3.10.3 Description of control circuit terminals

Table 3-4 Description of control circuit terminals

Type	Terminal Symbol	Terminal Name	Terminal function description
Power Supply	+10V-GND	External +10V power supply	Provide +10V power supply to external unit. Maximum output current:10mA Generally, it provides power supply to external potentiometer with resistance range of 1 kΩ~5kΩ
	+24V-COM	External +24V power supply	Provide +24 V power supply to external unit. Generally, it provides power supply to DI/DO terminals and external sensors. Maximum output current: 200 mA
	J4	External power supply input terminal	Connect to +24 V by default. When DI1-DI6 need to be driven by external signal, J4 must switch to be "OFF" status.
Analog input	AI1-GND	Analog input terminal 1	1. Input voltage range: DC 0V~10 V 2. Input Impedance: 22 kΩ
	AI2-GND	Analog input terminal 2	1. Input range: DC 0V~10V/ 0mA~20mA, decided by jumper J5 on the control board 2. Impedance: 22 kΩ (voltage input), 500 Ω (current input)
Digital input	DI1	Digital input 1	1. Optical coupling isolation, compatible with dual polarity input 2. Input Impedance: 2.4 kΩ 3. Voltage range for level input: 9V~30 V
	DI2	Digital input 2	
	DI3	Digital input 3	
	DI4	Digital input 4	
	DI5	Digital input 5	
Analog output	HDI	High Speed Pulse Input Terminal	Besides features of DI1~DI5 and it can be used for high-speed pulse input. Maximum input frequency: 50 kHz
	AO1-GND	Analog output terminal 1	Voltage or current output is decided by jumper J6. Output voltage range: 0V~10 V Output current range: 0mA~20 mA
	AO2-GND	Analog output terminal 2	Output voltage range: 0V~10V

Type	Terminal Symbol	Terminal Name	Terminal function description
Digital output	DO1-CME	Digital output 1	Optical coupling isolation, dual polarity open collector output. Output voltage range: 0V~24 V Output current range: 0mA~50 mA Note that CME and COM are internally insulated, but they are shorted by jumper externally by factory default. In this case DO1 is driven by +24 V, If you want to drive DO1 by external power supply, please remove jumper between CME and COM.
	FM- COM	High Speed Pulse Output Terminal	It is set by b4-00 (FM terminal output mode selection) As high-speed pulse output, the maximum frequency hits 100 kHz. As open-collector output, its function is the same as that of DO1.
Relay output	FM- COM	High Speed Pulse Output Terminal	It is set by b4-00 (FM terminal output mode selection) As high-speed pulse output, the maximum frequency hits 100 kHz. As open-collector output, its function is the same as that of DO1.
	TA-TB	NC terminal	Contact driving capacity: 250 VAC, 3 A, COS ϕ = 0.4 DC 30 V, 1 A
Auxiliary interface	TA-TC	NO terminal	
	JP1	Extension card interface	Connect to an optional card (I/O extension card, PLC card and various bus cards)
	J8	PG card interface	Support various types of PG cards: OC, differential, UVW ABZ and resolver.

3.10.4 Wiring of Analog Input Terminals

When the voltage signal is used as analog input, it is vulnerable from outside interference. Please use shielding cable, and ensure that the shielding cable reliably connect to the grounding. The cable should be as short as possible, and keep away from power lines. In serious interference occasions, you might consider to add a filter capacitor or ferrite core in signal cable.

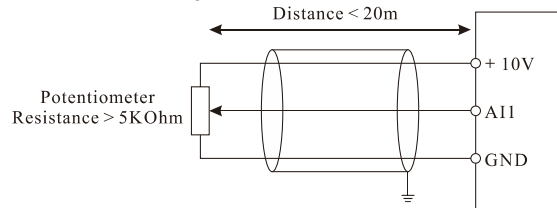
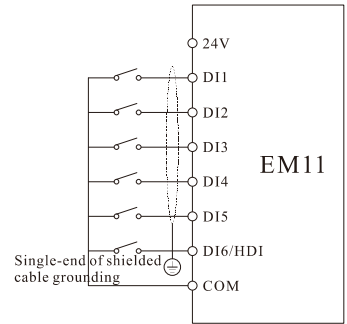

Diagram 3-13 Wiring of analog input terminals

3.10.5 Wiring of Multi-functional Input Terminals

D1 wiring mode 1 (Factory default wiring mode): The external power supply is not used when D1 is set as NPN mode.



D1 wiring mode 2: The external power supply is used when D1 is set as NPN mode.

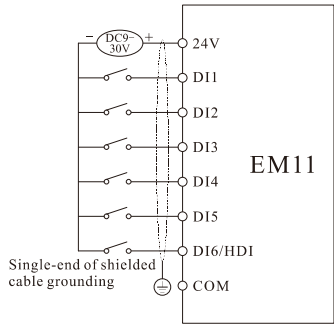

D1 wiring mode 3: The external power supply is not used when D1 is set as NPN mode.

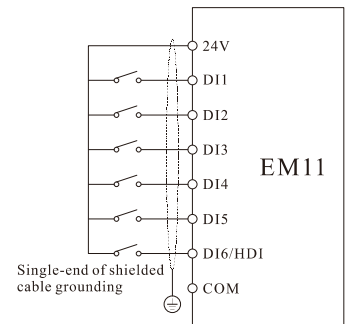

D1 wiring mode 4: The external power supply is used when D1 is set as NPN mode.

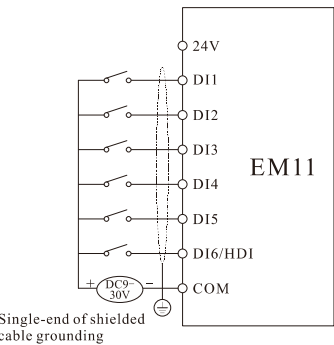
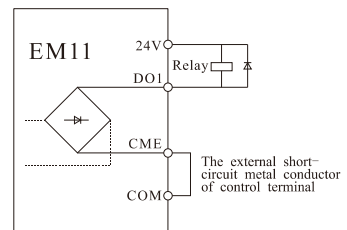
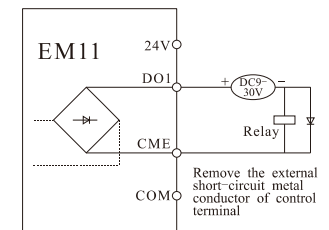

Diagram 3-14 Wiring of digital input terminals in four different modes

3.10.6 Wiring of digital output terminals when using internal and external power supply



3-15 Internal power supply wiring



3-16 External power supply wiring

Note: When external power supply is adopted, please connect negative end of external power supply with terminal COM. The maximum current of open-collector output is 50mA. If the external load is a relay,

please install a fly-wheel diode to the two sides of relay. Please correctly install the polarity of fly-wheel diode, otherwise control card and DSP can be damaged.

3.10.7 Description of Control Circuit Jumper

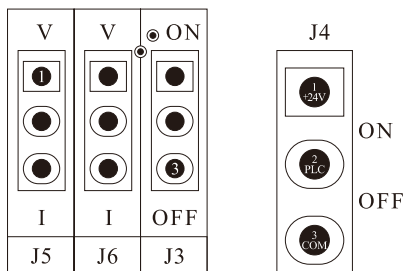

Jumper Name	Function Description	Default Setting
J3	When the jumper is "ON", it connects with 485 communication resistor. When the jumper is "OFF", it disconnects with 485 communication resistor	OFF
J4	When the jumper is "ON", DI terminals use internal power supply. When the jumper is "OFF", DI terminals use external power supply.	ON
J5	When the jumper is "V", AI2 is with voltage input (0V~10V). When the jumper is "I", AI2 is with current input (0mA~20mA).	V
J6	When the jumper is "V", AO1 is with voltage output (0V~10V). When the jumper is "I", AO1 is with current output (0mA~20mA).	V

4. Operation and display

4.1 Instruction of operation and display

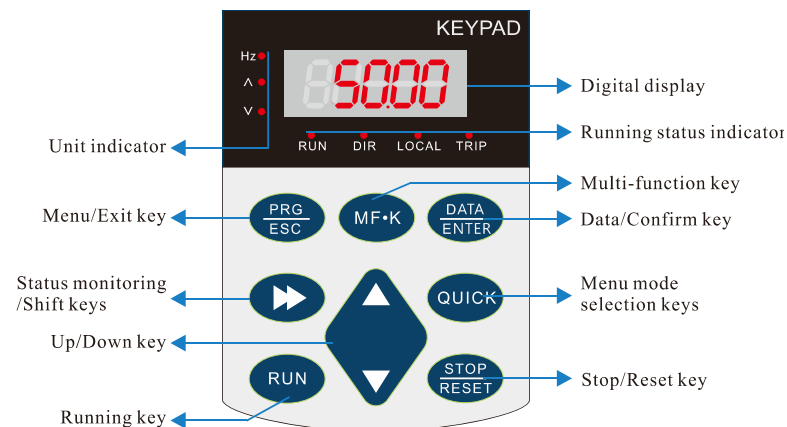

Diagram 4-1 EM11 main keypad

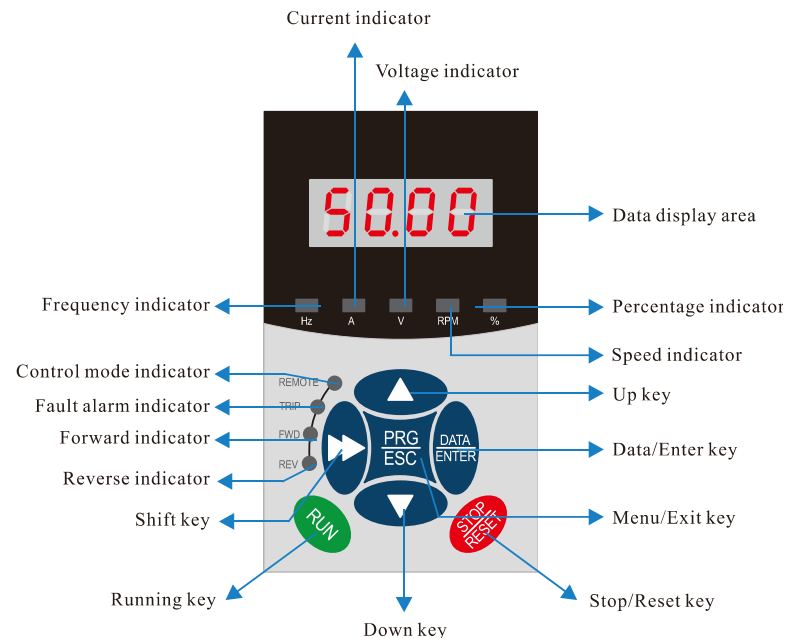

Diagram 4-2 EM11-G1/G3E keypad

1. Description of indicator

RUN: OFF indicates that the frequency inverter is in the stop state and ON indicates that the frequency inverter is in the running state.

LOCAL: It indicates whether the frequency inverter is operated by operation keypad, terminals or remoter (communication). OFF indicates keypad operation control state; ON indicates terminals operation control state; Blinking indicates remote operation control state.

DIR: It is Forward/Reversal indicator, ON indicates forward rotation.

TRIP: Tuning/ Torque Control/Fault indicator

When the indicator is ON, it indicates torque control mode. When the indicator is blinking slowly, it indicates the auto-tuning state. When the indicator is blinking quickly, it indicates the fault state.

2. Unit indicator

Hz: frequency unit;

A: Current unit;

V: Voltage unit

3. Digital display area

The 5-digit LED display is able to display the set frequency, output frequency, monitoring data and fault codes.

4. Description of Keys on the Operation panel (keypad)

Table 4-1 Keypad function table

Key	Name	Function
PRG/ESC	Programming	Enter or exit menu level I.
DATA/ENTER	Confirmation	Enter the menu interfaces level by level, and confirm the parameter setting.
△	Increment	Increase data or function code.
▽	Decrement	Decrease data or function code.
▷▷	Shift	Select the displayed parameters in turn in the stop or running state, and select the digit to be modified when modifying parameters.
RUN	RUN	Start the frequency inverter in the operation panel control mode.
STOP/RESET	Stop/Reset	Stop the frequency inverter when it is in the running state and perform the reset operation when it is in the fault state. The functions of this key are restricted by b9-00.
MF.K	Multi-function	Perform function switchover according to the setting of b9-01
QUICK	Menu mode selection	Perform switchover between menu modes according to the setting of A0-08(The default is a menu mode).

4.2 Viewing and Modifying Function Codes

The operation panel of the EM11 adopts three-level menu.

The three-level menu consists of function code group (Level I), function code (Level II), and function code setting value (level III), as shown in the following figure.

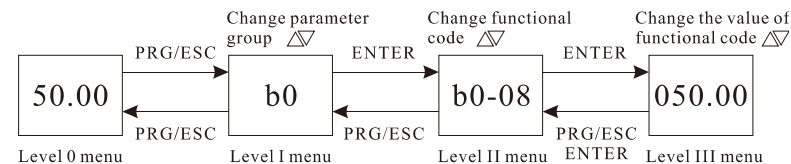

Diagram 4-3 Operation procedure on the operation panel

Instruction: We can return to level II menu from Level III menu by pressing PRG or ENTER.

The difference between them is:

After you press ENTER, the system saves the parameter setting first, and then goes back to Level II menu and shifts to the next function code.

After you press PRG, the system does not save the parameter setting, but directly returns to Level II menu and remains at the present function code.

Under the Level III state, if there is no blinking digit of this parameter, then it indicates that the parameter can not to be modified. The possible reasons are:

1. This function code is a non-modifiable parameter, such as the actual testing parameters, operation records, etc.
2. This function code cannot be modified under the running state, but can modify after stopping.

4.3 Parameter Display Mode

The establishment of parameter display is to make the user conveniently to check the parameters in different permutation modes. Three kinds of parameter display modes are offered.

Name	Description
Function parameter mode	sequential display the function parameters of frequency inverter, includes parameter group b0 ~ bF, C0 ~ C6, d0 ~ d6, A0 ~ A1 and U0
Customized parameter mode	Several function parameters (max 32) customized to display are need to confirmed by Group A1
Modifiable parameter mode	The function parameters can be different with the factory parameter

Relevant function parameters are A0-08, as follows:

Code	Parameter Name	Setting Range	Default
A0-08	Display of customized parameter	Bit: User-defined parameter QUICK display selection. 0: No Display 1: Display Ten bit: User-changed parameter QUICK display selection. 0: No Display 1: Display	0

When user defined customized parameters, at this time user can switch into different parameter display mode by the QUICK key.

All parameter display mode display the code as follows:

Parameter Display Mode	Display
Base mode	-dFLt
User-defined mode	-user
User-modified mode	-chGd

Switching mode is as follows:

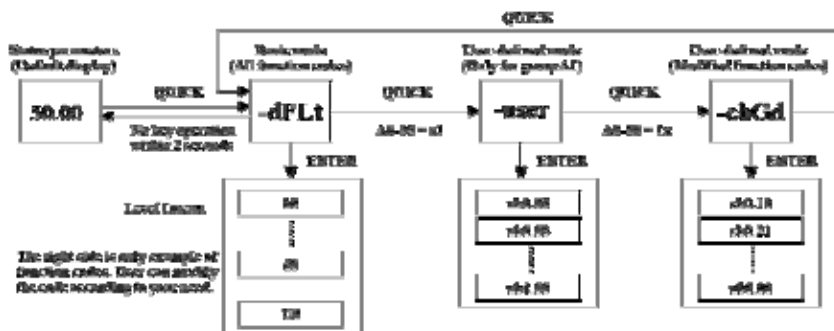

Diagram 4-4 Quick viewing mode of function codes

4.4 The operation of User-defined Fast Menu of Parameters

User-defined menu is set to facilitate user to quickly view and modify the commonly used function codes. In this mode, the display parameter "ub0.02" is function code "b0-02". User also can modify parameters value in this menu, the effect is same as modifying in common menu.

The user-defined parameters set by group A1. If A1 is set to A0.00, it indicates that no function codes are available. The max 32 parameters can be defined in group A1. If "NULL" is displayed, it indicates that the user-defined menu is empty.

A total of 16 parameters are pre-stored in the user-defined fast menu, as listed in the following table.

b0-01	Control mode
b0-02	Command source selection
b0-03	Main frequency source X selection
b0-07	Frequency source selection
b0-12	Preset frequency
b0-21	Acceleration time
b0-22	Deceleration time
b3-00	DI1 function selection
b3-01	DI2 function selection
b3-02	DI3 function selection
b4-04	DO1 output selection
b6-01	AO1 output selection
b1-00	Start mode
b1-10	Stop mode

d2-00	V/F curve setting
d2-01	Torque boost

User can modify the user-defined fast menu based on actual requirements.

4.5 Monitoring Status Parameters

In the stop or running state, you can press "▶▶" on the operation panel to display status parameters. Whether parameters are displayed is determined by the binary bits of values converted from the values of b9-02(running parameter 1), b9-03(running parameter 2), and b9-04(stopping parameter) in the hexadecimal format.

In stop state, there are 16 status parameters you can select to displayed or not, they are: setting frequency, bus voltage, DI input status, DO output status, analog input AI1 voltage, analog input AI2 voltage, analog input AI3 voltage, count value, length value, PLC running step, load speed, PID setting, PULSE input frequency and three reserved parameters.

In running state, there are five running state parameters: running frequency, setting frequency, bus voltage, output voltage and output current. This five parameters are default displaying. The other display parameter includes output power, output torque, DI input status, DO output status, analog input AI1 voltage, analog input AI2 voltage, analog input AI3 voltage, count value, length value, linear speed, PID setting, PID feedback, etc. You can set whether these parameters are displayed by setting b9-02 and b9-03.

When the frequency inverter is repowered on again after power failure, the parameters are recorded as before power failure and displaying.

4.6 Password Setting

The frequency inverter provides the user password protection function. When A0-00 is set to a non-zero value, the value is the user password. The password takes effect after you exit the function code editing state. When you press PRG key, "-----" will be displayed, and you must enter the correct user password to enter the menu.

To cancel the password protection function, enter with password and set A0-00 to 0.

4.7 Motor parameter auto-tuning

Select vector control running mode, before frequency inverter start to operate, you must accurately write in the nameplate parameter of motor by keypad. EM11 frequency inverter will match standard motor parameter according to the nameplate; the vector control mode strongly depended on motor's parameters, if you want to get good control performance, then you must let inverter to obtain the exact parameters of controlled motor.

The process of motor auto-tuning is as follows:

Firstly, select command source (b0-03) as keypad command channel. Then write in the actual motor parameters as the following parameters (according to the nameplate of present motor):

Motor	Parameter	
Motor 1	b0-00 : Motor Type Selection d0-01 : Motor Rated Voltage d0-03 : Motor Rated Frequency	d0-00 : Motor Rated Power d0-02 : Motor Rated Current d0-04 : Motor Rated Speed
Motor 2	b0-00 : Motor Type Selection d2-01 : Motor Rated Voltage d2-03 : Motor Rated Frequency	d2-00 : Motor Rated Power d2-02 : Motor Rated Current d2-04 : Motor Rated Speed

AC asynchronous motor tuning

If the motor can be disconnected from the load, then please set d0-30/d2-30 to 2(asynchronous motor complete auto-tuning), then press the RUN key on the keypad. The frequency inverter will automatically calculate the following parameters of motor:

Motor	Parameter	
Motor 1	d0-05 : Stator resistance (asynchronous motor) d0-06 : Rotor resistance (asynchronous motor) d0-07 : Leakage inductive reactance(asynchronous motor) d0-08 : Mutual inductive reactance(asynchronous motor) d0-09 : No-load current(asynchronous motor)	
Motor 2	d2-05 : Stator resistance (asynchronous motor) d2-06 : Rotor resistance (asynchronous motor) d2-07 : Leakage inductive reactance(asynchronous motor) d2-08 : Mutual inductive reactance(asynchronous motor) d2-09 : No-load current(asynchronous motor)	

Finish motor parameter auto-tuning.

If the motor cannot be fully disconnected with the load, then please select d0-30/d2-30 as 1 (asynchronous static auto-tuning), and press the RUN key in the keypad panel.

And the frequency inverter will automatically calculate the following parameters of motor:

Motor	Parameter	
Motor 1	d0-05 : Stator resistance (asynchronous motor) d0-06 : Rotor resistance (asynchronous motor) d0-07 : Leakage inductive reactance(asynchronous motor)	
Motor 2	d2-05 : Stator resistance (asynchronous motor) d2-06 : Rotor resistance (asynchronous motor) d2-07 : Leakage inductive reactance(asynchronous motor)	

Description of synchronous motor identification:

As the EM11 driven synchronous machine system needs the feedback signal from encoder, so uses need to correctly set the parameter of encoder before identification.

During the identification process of synchronous system, rotation movement is needed. The best identification method is no-load dynamic running identification, if the condition is not allowed; with-load dynamic identification is workable.

5. Description of Function Codes

5.1 Group b0: Basic Function Parameters

Code	Parameter Name	Setting Range	Default
b0-00	Motor type selection	Unit's digit: Motor 1 selection Ten's digit: Motor 2 selection 0: AC asynchronous motor 1: Permanent magnetic synchronous motor	0

Unit's digit: 0- select Motor 1 as AC asynchronous motor;

1-select Motor 1 as Permanent magnetic synchronous motor

Ten's digit: 0-select Motor 2 as AC asynchronous motor;

1-select Motor 2 as Permanent magnetic synchronous motor

Code	Parameter Name	Setting Range	Default
b0-01	Motor control mode	Unit's digit: Motor 1 control mode selection. Ten's digit: Motor 2 control mode selection. 0: Sensor-less vector control (SVC) 1: Closed-loop vector control (VC) 2:V/F control Hundred's digit/Thousand's digit: reserved Ten thousand's digit: Motor selection 0: Motor 1 1: Motor 2	0

Unit's digit and Ten's digit is to select motor 1 and motor 2 control mode.

● 0: Sensor less vector control (SVC)

It indicates open-loop vector control, and is applicable to high-performance control applications such as machine tool, centrifuge, wire drawing machine and injection molding machine. One frequency inverter can operate only one motor.

● 1: Closed-loop vector control (VC)

It is applicable to high-accuracy speed control or torque control applications such as high-speed paper making machine, crane and elevator. One Frequency inverter can operate only one motor. An encoder must be installed at the motor side, and a PG card matching the encoder must be installed at the frequency inverter side.

● 2: Voltage/Frequency (V/F) control

It is applicable to applications with low requirements or applications where one frequency inverter operates multiple motors, such as fan and pump.

Note: If vector control is used, motor auto-tuning must be performed because the advantages of vector control can only be utilized after correct motor parameters are obtained. Better performance can be achieved by adjusting speed regulator parameters in group "d".

For the permanent magnetic synchronous motor (PMSM), the EM11 does not support SVC. VC is used generally. In some low requirements applications, you can also use V/F.

Code	Parameter Name	Setting Range	Default
b0-02	Command source selection	0: Keypad control (LED off) 1: Terminal control (LED on) 2: Communication control (LED blinking)	0

It is used to determine the input channel of the frequency inverter control commands, such as run, stop, forward rotation, reverse rotation and jog operation. You can input the commands in the following three channels:

0: Keypad control ("LOCAL/REMOT" indicator off)

Commands are given by pressing keys "RUN" and "STOP/RESET" on the operation panel.

1: Terminal control ("LOCAL/REMOT" indicator on)

Commands are given by means of multifunctional input terminals with functions such as FWD, REV, JOGF, and JOGR.

2: Communication control ("LOCAL/REMOT" indicator blinking)

Commands are given from host computer. For more details please refer to the appendix of communication protocol.

Code	Parameter Name	Setting Range	Default
b0-03	Main frequency source X selection	0: Digital setting (Preset frequency b0-12, UP/DOWN modifiable, no-record after power off) 1: Digital setting (Preset frequency b0-12, UP/DOWN modifiable, record after power off) 2: AI1 3: AI2 4: AI3 5: Pulse setting (DI6) 6: Multi-function 7: Built-in PLC 8: PID 9: Communication setting	0

It is used to select the setting channel of the main frequency. You can set the main frequency in the following 10 channels:

0: Digital setting (Preset frequency b0-12, UP/DOWN modifiable, not record at power failure)

The initial value of the set frequency is the value of b0-12 (Preset frequency). You can change the set frequency by pressing Δ and ∇ on the operation panel (or using the UP/DOWN function of input terminals).

When the Frequency inverter is powered on again after power failure, the set frequency reverts to the value of b0-12.

1: Digital setting (Preset frequency b0-12, UP/DOWN modifiable, record at power failure)

The initial value of the set frequency is the value of b0-12 (Preset frequency). You can change the set frequency by pressing keys Δ and ∇ on the operation panel (or using the UP/DOWN functions of input terminals).

When the frequency inverter is powered on again after power failure, the setting frequency is the value memorized at the moment of the last power failure.

Note that b0-10 (record digital setting frequency of power failure) determines whether the set frequency is memorized or cleared when the frequency inverter stops. It is related to stopping rather than power failure.

2: AI1

3: AI2

4: AI3

The frequency is set by analog input. The EM11 control board provides two analog input (AI) terminals (AI1, AI2). Another AI terminal (AI3) is provided by the I/O extension card.

Including:

AI1: 0V~10 V voltage input;

AI2: 0V~10 V voltage input or 4mA~20 mA current input, determined by jumper on the control card;

AI3: -10V~10 V voltage input

The corresponding relationship curve between the input voltage of AI1, AI2 and AI3 and the target frequency can be user-defined.

When AI is used as the frequency setting source, the corresponding value 100% of the voltage/current input corresponds to the value of b0-13 (Maximum frequency).

5: Pulse setting (DI6)

The frequency is set by DI6 (high-speed pulse). The signal specification of pulse setting is 9V~30V (voltage range) and 0 kHz~100 kHz (frequency range). Pulse can be only input by DI6.

The relation between DI6 terminal input pulse frequency and corresponding setting is set by b5-00~ b5-03. The corresponding relation is the linear relation of these two points. The corresponding value 100% of pulse setting corresponds to the value of b0-13 (Maximum frequency).

6: Multi-function

In Multi-segment speed mode, combinations of different DI terminal states correspond to different set frequencies. The EM11 supports a maximum of 16 speeds implemented by 16 state combinations of four DI terminals (set with functions 12 to 15) in Group C1. The multiple segments speed indicates percentages of the value of b0-13 (Maximum frequency).

If a DI terminal is used for the Multi-function function, you need to perform related setting in group b3. For details, refer to the descriptions of Group b3.

7: Simple PLC (built-in)

When the simple programmable logic controller (PLC) mode is used as the frequency source, the running frequency of the frequency inverter can be switched over among the 16 frequency references. You can set the holding time and acceleration/deceleration time of the 16 frequency references. For details, refer to the descriptions of Group C2.

8: PID

The output of PID control is used as the running frequency. PID control is generally used in on-site closed-loop control, such as constant pressure closed-loop control and constant tension closed-loop control. When applying PID as the frequency source, you need to set parameters of "PID function" in group C0.

9: Communication setting

The frequency is set by means of communication.

Code	Parameter Name	Setting Range	Default
b0-04	Auxiliary frequency source Y selection	0: Digital setting (Preset frequency b0-12, UP/DOWN modifiable, no-record after power off) 1: Digital setting (Preset frequency b0-12, UP/DOWN modifiable, record after power off) 2: AI1 3: AI2 4: AI3 5: Pulse setting (DI6) 6: Multi-function 7: Built-in PLC 8: PID 9: Communication setting	1

When used as an independent frequency input channel (frequency source switched over from X to Y), the auxiliary frequency source Y is used in the same way as the main frequency source X (refer to b0-03).

When the auxiliary frequency source is used for operation (frequency source is "X and Y operation"), pay attention to the following aspects:

- If the auxiliary frequency source Y is digital setting, the preset frequency (b0-12) does not take effect. You can directly adjust the set main frequency by pressing keys Δ and ∇ on the operation panel (or using the UP/DOWN function of input terminals).
- If the auxiliary frequency source is analog input (AI1, AI2 and AI3) or pulse setting, 100% of the input corresponds to the range of the auxiliary frequency Y (set in b0-05 and b0-06).
- If the auxiliary frequency source is pulse setting, it is similar to analog input.

Note: The main frequency source X and auxiliary frequency source Y must not use the same channel. That is, b0-03 and b0-04 cannot be set to the same value in case of confusion.

Code	Parameter Name	Setting Range	Default
b0-05	Selection of auxiliary frequency Y range	0: Relative to maximum frequency 1: Relative to main frequency X	0
b0-06	Range of auxiliary frequency Y	0%~150%	100%

If X and Y operation is used, b0-05 and b0-06 are used to set the adjustment range of the auxiliary frequency source.

You can set the auxiliary frequency to be relative to either maximum frequency or main frequency X. If relative to main frequency X, the setting range of the auxiliary frequency Y varies according to the main frequency X.

Code	Parameter Name	Setting Range	Default
b0-07	Frequency source selection	Unit's digit: Frequency source selection. 0: Main frequency source X 1: X and Y calculation (calculation result determined by ten's digit) 2: Switchover between X and Y 3: Switchover between X and "X and Y calculation" 4: Switchover between Y and "X and Y calculation" Ten's digit: X and Y calculation relationship 0: X+Y 1: X-Y 2: Maximum of them 3: Minimum of them	0

It is used to select the frequency setting channel. Frequency setting can be realized by the main frequency source X and auxiliary frequency source Y operation.

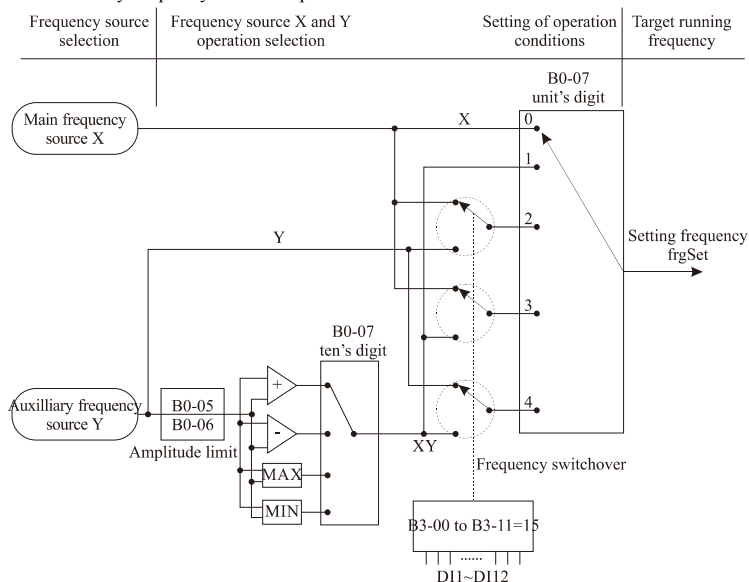

Diagram 5-1 Target frequency setting

If the frequency source involves X and Y operation, you can set the frequency offset in b0-08 for superposition to the X and Y operation result, flexibly satisfying various requirements.

Code	Parameter Name	Setting Range	Default
b0-08	Frequency offset of auxiliary frequency source of X and Y	0.00 Hz ~ maximum frequency(b0-13)	0.00 Hz

This parameter is valid only when the frequency source is set to "X and Y operation". The final frequency is obtained by adding the frequency offset set in this parameter to the X and Y operation result.

Code	Parameter Name	Setting Range	Default
b0-09	Binding command source to frequency source	Unit's digit: Binding keypad command to following frequency source. 0: No binding 1: Frequency source by digital setting 2: AI1 3: AI2 4: AI3 5: Pulse setting (DI6) 6: Multi-function 7: Simple PLC 8: PID 9: Communication setting Ten's digit: Binding terminal command to frequency source. 0~9, same as unit's digit Hundred's digit: Binding communication command to frequency source. 0~9, same as unit's digit Thousand's digit: Automatically running binding to frequency source. 0~9, same as unit's digit	0

It is used to bind the three running command sources with the nine frequency sources, facilitating to implement synchronous switchover.

For details on the frequency sources, see the description of b0-03 (Main frequency source X selection).

Different running command sources can be bound to the same frequency source.

If a command source has bound to a frequency source, this frequency source set in b0-03~ b0-07 no longer takes effect when this command source is effective.

Code	Parameter Name	Setting Range	Default
b0-10	Record of digital setting frequency of power failure	0: not record 1: record	1

This parameter is valid only when the frequency source is digital setting.

If b0-10 is set to 0, the digital setting frequency value restore to the value of b0-12 (Preset frequency) after the frequency inverter stops. The modification by using keys Δ and ∇ or the terminal UP/DOWN function is cleared to zero.

If b0-10 is set to 1, the digital setting frequency value is the set frequency at the moment when the frequency inverter stops. The modification by using keys Δ and ∇ or the terminal UP/ DOWN function remains is record and valid.

Code	Parameter Name	Setting Range	Default
b0-11	Frequency unit	1: 0.1 Hz 2: 0.01 Hz	2

It is used to set the resolution of all frequency-related parameters.

If the resolution is 0.1 Hz, the EM11 can output up to 3000.0Hz. If the resolution is 0.01 Hz, the EM11 can output up to 300.00 Hz.

Note:

- Modifying this parameter will make the decimal places of all frequency-related parameters change and

corresponding frequency values change display.

- This parameter is not restored when factory fault setting is done.

Code	Parameter Name	Setting Range	Default
b0-12	Preset frequency	0.00 ~ maximum frequency (b0-13)	50.00 Hz

If the frequency source is digital setting or terminal UP/DOWN, the value of this parameter is the initial frequency of the frequency inverter (digital setting).

Code	Parameter Name	Setting Range	Default
b0-13	Maximum frequency	50.00~3000.00 Hz	50.00 Hz

When the frequency source is AI, pulse setting (DI6), or Multi-segment speed, the 100% of input corresponds to the value of this parameter.

The output frequency of the EM11 can reach up to 3000 Hz. To take both frequency reference resolution and frequency input range into consideration, you can set the number of decimal places for frequency reference in b0-11.

- If b0-11 is set to 1, the frequency reference resolution is 0.1 Hz. In this case, the setting range of b0-13 is 50.0 to 3000.0 Hz.
- If b0-11 is set to 2, the frequency reference resolution is 0.01 Hz. In this case, the setting range of b0-13 is 50.00 to 300.00 Hz.

Note: After the value of b0-11 is modified, the frequency resolution of all frequency related function codes change accordingly.

Code	Parameter Name	Setting Range	Default
b0-14	Source of frequency upper limit	0: Set by (b0-15) 1: AI1 2: AI2 3: AI3 4: Pulse setting (DI6) 5: Communication setting	0

It is used to set the source of the frequency upper limit, including digital setting (b0-15), AI, pulse setting or communication setting. If the frequency upper limit is set by means of AI1, AI2, AI3, DI5 or communication, the setting is similar to that of the main frequency source X. For details, see the description of b0-03.

For example, to avoid runaway in torque control mode in winding machine application, you can set the frequency upper limit by means of analog input. When the frequency inverter reaches the upper limit, it will run at this limited speed.

Code	Parameter Name	Setting Range	Default
b0-15	Frequency upper limit	Frequency lower limit (b0-17)~maximum frequency (b0-13)	50.00 Hz

This parameter is used to set the frequency upper limit.

Code	Parameter Name	Setting Range	Default
b0-16	Frequency upper limit offset	0.00 Hz~ maximum frequency(b0-13)	0.00 Hz

If the source of the frequency upper limit is analog input or pulse setting, the final frequency upper limit is obtained by adding the offset in this parameter to the frequency upper limit set in b0-14.

Code	Parameter Name	Setting Range	Default
b0-17	Frequency lower limit	0.00 Hz ~frequency upper limit(b0-15)	0.00 Hz

If the frequency command is lower than the value of this parameter, the frequency inverter can stop, or run at the frequency lower limit, or run at zero speed. The result can be determined by b2-17(setting frequency lower than frequency lower limit running mode).

Code	Parameter Name	Setting Range	Default
b0-18	Rotation direction	0: Forward direction 1: Reverse direction	0

You can change the rotation direction of the motor just by modifying this parameter without changing the motor wiring. Modifying this parameter is equivalent to exchanging any two phase of the motor's U, V, W wires.

Note:

The motor will restore original running direction after parameter initialization (A0-09). Do not use this function in applications where changing the rotating direction of the motor is prohibited after system commissioning is complete.

Code	Parameter Name	Setting Range	Default
b0-19	Base frequency for UP/DOWN modification during running	0: Running frequency 1: Setting frequency	0

This parameter is valid only when the frequency source is digital setting.

It is used to set the base frequency to be modified by using keys Δ and ∇ or the terminal UP/DOWN function. If the running frequency and setting frequency are different, there will be a large difference between the frequency inverter's performance during the acceleration/ deceleration process.

Code	Parameter Name	Setting Range	Default
b0-20	Acceleration/Deceleration mode	0: Linear acceleration/ deceleration 1: S-curve acceleration/deceleration A 2: S-curve acceleration/deceleration B	0

It is used to set the frequency changing mode during the frequency inverter start and stop process.

0: Linear acceleration/deceleration

The output frequency increases or decreases in linear mode. The EM11 provides four groups of acceleration/deceleration time, which can be selected by using multi-function DI terminals (b3-00 to b3-11).

1: S-curve acceleration/deceleration A

The output frequency increases or decreases along the S curve. This mode is generally used in the applications where start and stop processes are required relatively smooth, such as elevator and conveyor belt. The b0-23 and b0-24 respectively define the time proportions of the start segment and the end segment.

2: S-curve acceleration/deceleration B

In this curve, the rated motor frequency f_b is always the inflexion point of S curve. This mode is usually used in applications where acceleration/deceleration is required at the speed higher than the rated frequency.

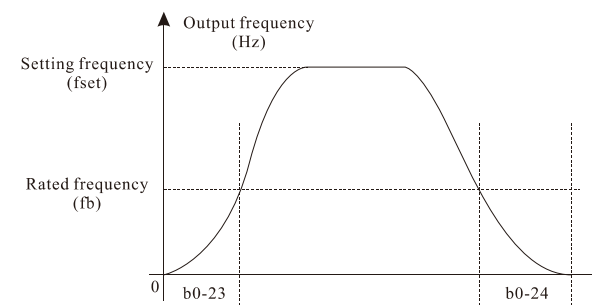

Diagram 5-2 S-curve acceleration/deceleration B diagram

Code	Parameter Name	Setting Range	Default
b0-21	Acceleration time 1	0.00s~650.00s (b0-25 = 2) 0.0s~6500.0s (b0-25 = 1) 0s~65000s (b0-25 = 0)	Model dependent

Code	Parameter Name	Setting Range	Default
b0-22	Deceleration time 1	0.00s~650.00s (b0-25 = 2) 0.0s~6500.0s (b0-25 = 1) 0s~65000s (b0-25 = 0)	Model dependent

Acceleration time indicates the time required by the frequency inverter to accelerate from 0 Hz to "Acceleration / Deceleration base frequency" (b0-26), that is, t_1 in Diagram 6-3. Including, f is setting frequency, f_b is motor rated frequency, T is the acceleration time from 0 Hz to rated frequency f_b .

Deceleration time indicates the time required by the frequency inverter to decelerate from "Acceleration / Deceleration base frequency" (b0-26) to 0 Hz, that is, t_2 in Diagram 6-3.

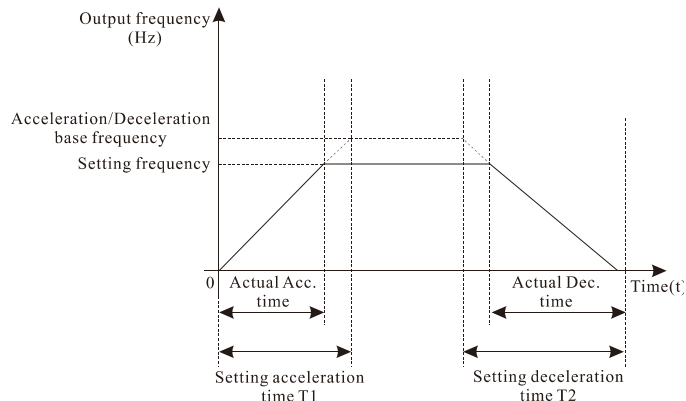

Diagram 5-3 Acceleration/Deceleration time

The EM11 provides totally four groups of acceleration/deceleration time for selection. You can perform switchover by using a DI terminal. And you can set the four groups of acceleration/deceleration time through the following function codes:

- Group 1: b0-21, b0-22
- Group 2: b2-03, b2-04
- Group 3: b2-05, b2-06
- Group 4: b2-07, b2-08

Code	Parameter Name	Setting Range	Default
b0-23	Time proportion of S-curve start segment	0.0% ~ (100.0% minus b0-24)	30.0%
b0-24	Time proportion of S-curve end segment	0.0% ~ (100.0% minus b0-23)	30.0%

These two parameters respectively define the time proportions of the start segment and the end segment of S-curve acceleration/deceleration A.

In Diagram 6-4, t_1 is the time defined in b0-23, within which the slope of the output frequency change increases gradually. t_2 is the time defined in b0-24, within which the slope of the output frequency change gradually decreases to 0. Within the time between t_1 and t_2 , the slope of the output frequency change remains unchanged, that is, linear acceleration/ deceleration.

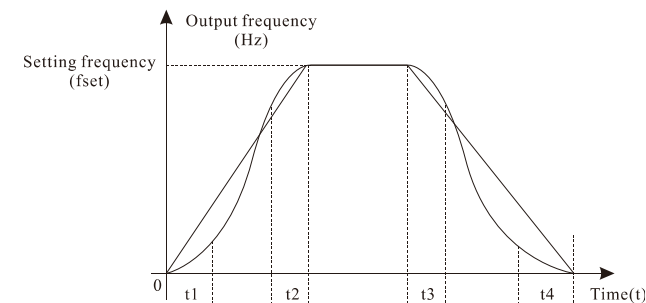

Diagram 5-4 S-curve acceleration/deceleration A

Code	Parameter Name	Setting Range	Default
b0-25	Acceleration/Deceleration time unit	0: 1s 1: 0.1s 2: 0.01s	1

To satisfy requirements of different applications, the EM11 provides three acceleration/ deceleration time units, 1s, 0.1s and 0.01s.

Note: Modifying this parameter will make the decimal places of all frequency-related parameters change and corresponding frequency values change. Pay attention for this in on-site application.

Code	Parameter Name	Setting Range	Default
b0-26	Acceleration/Deceleration time base frequency	0: Maximum frequency (b0-13) 1: Set frequency 2: 100 Hz	0

The acceleration/deceleration time indicates the time for the frequency inverter to increase from 0 Hz to the frequency set in b0-26, figure 6-3 is the acceleration/deceleration time diagram. If this parameter is set to 1, the acceleration/deceleration time is related to the set frequency. If the set frequency changes frequently, the motor's acceleration/deceleration also changes.

5.2 Group b1: Start/Stop Control Parameters

Code	Parameter Name	Setting Range	Default
b1-00	Start mode	0: Direct start 1: Rotational speed tracking restart 2: Pre-excited start (AC asynchronous motor)	0

0: Direct start

If the DC braking time is set to 0, the frequency inverter starts to run from the startup frequency.

If the DC braking time is not 0, the frequency inverter performs DC braking first and then starts to run from the startup frequency. It is applicable to small-inertia load application and to where the motor is likely to rotate at startup.

1: Rotational speed tracking restart

The frequency inverter judges the rotational speed and direction of the motor firstly, and then starts at the tracked frequency. Such smooth start has no impact on the rotating motor. It is applicable to the restart of instantaneous power failure of large-inertia loads. To ensure the perfect performance of rotational speed tracking restart, please set the motor parameters correctly.

2: Pre-excited start (asynchronous motor)

It is valid only for asynchronous motor and used for building the magnetic field before the motor runs.

For pre-excited current and pre-excited time, see parameters of b1-05 and b1-06.

If the pre-excited time is 0, the frequency inverter cancels pre-excitation and starts to run from startup

frequency.

If the pre-excited time is not 0, the frequency inverter pre-excites firstly before startup, improving the dynamic response of the motor.

Code	Parameter Name	Setting Range	Default
b1-01	Rotational speed tracking mode	0: From frequency at stop 1: From zero speed 2: From maximum frequency	0

To complete the rotational speed tracking process within the shortest time, select the proper mode in which the frequency inverter tracks the motor rotational speed.

0: From frequency at stop

It is the commonly selected mode.

1: From zero frequency

It is applicable to restart after a long time of power failure.

2: From the maximum frequency

It is applicable to the power-generating load.

Code	Parameter Name	Setting Range	Default
b1-02	Rotational speed tracking speed	1~100	20

In the rotational speed tracking restart mode, select the rotational speed tracking speed. The larger the value is, the faster the tracking is. However, too large value may cause unreliable tracking.

Code	Parameter Name	Setting Range	Default
b1-03	Startup frequency	0.00~10.00 Hz	0.00 Hz
b1-04	Startup frequency holding time	0.0s~100.0s	0.0s

To ensure the motor torque at frequency inverter startup, set a proper startup frequency. In addition, to build excitation when the motor starts up, the startup frequency must be held for a certain period.

The startup frequency (b1-03) is not restricted by the frequency lower limit. If the setting target frequency is lower than the startup frequency, the frequency inverter will not start and stays in the holding state.

During switchover between forward rotation and reverse rotation, the startup frequency holding time is disabled. The holding time is not included in the acceleration time but in the running time of simple PLC.

Example 1:

b0-03 = 0	The frequency source is digital setting.
b0-12 = 2.00 Hz	The digital setting frequency is 2.00 Hz.
b1-03 = 5.00 Hz	The startup frequency is 5.00 Hz.
b1-04 = 2.0s	The startup frequency holding time is 2.0s.

In this example, the frequency inverter stays in the holding state and the output frequency is 0.00 Hz.

Example 2:

b0-03 = 0	The frequency source is digital setting.
b0-12 = 10.00 Hz	The digital setting frequency is 10.00 Hz.
b1-03 = 5.00 Hz	The startup frequency is 5.00 Hz.
b1-04 = 2.0s	The startup frequency holding time is 2.0s.

In this example, the frequency inverter accelerates to 5.00 Hz at 2s, and then accelerates to the set frequency 10.00 Hz.

Code	Parameter Name	Setting Range	Default
b1-05	Startup DC braking current/ Pre-excited current	0%~100%	0%
b1-06	Startup DC braking time/ Pre-excited time	0.0s~100.0s	0.0s

Startup DC braking is generally used during restart of the frequency inverter after the rotating motor stops. Pre-excitation is used to make the frequency inverter build magnetic field for the asynchronous motor before startup to improve the responsiveness.

Startup DC braking is valid only for direct start (b1-00 = 0). In this case, the frequency inverter performs DC braking at the setting startup DC braking current. After the startup DC braking time, the frequency inverter starts to run. If the startup DC braking time is 0, the frequency inverter starts directly without DC braking. The larger the startup DC braking current is, the larger the braking force is.

If the startup mode is pre-excited start (b1-00 = 3), the frequency inverter firstly builds magnetic field based on the set pre-excited current. After the pre-excited time, the frequency inverter starts to run. If the pre-excited time is 0, the frequency inverter starts directly without pre-excitation.

The startup DC braking current or pre-excited current is a percentage of motor rated current.

Code	Parameter Name	Setting Range	Default
b1-07	Stop mode	0: Decelerate to stop 1: free stop	0

0: Decelerate to stop

After the stop command is enabled, the frequency inverter decreases the output frequency according to the deceleration time and stops when the frequency decreases to zero.

1: Free stop

After the stop command is enabled, the frequency inverter immediately stops the output. The motor will free stop based on the mechanical inertia.

Code	Parameter Name	Setting Range	Default
b1-08	DC braking initial frequency of stopping	0.00 Hz ~ maximum frequency	0.00 Hz
b1-09	DC braking waiting time of stopping	0.0s~100.0s	0.0s
b1-10	DC braking current of stopping	0%~100%	0%
b1-11	DC braking time of stopping	0.0s~100.0s	0.0s

● b1-08 (Initial frequency of stop DC braking)

During the process of decelerating to stop, the frequency inverter starts DC braking when the running frequency is lower than the value set in b1-08.

● b1-09 (Waiting time of stop DC braking)

When the running frequency decreases to the initial frequency of stop DC braking, the frequency inverter stops output for a certain period and then starts DC braking. This prevents faults such as over current caused due to DC braking at high speed.

● b1-10 (Stop DC braking current)

This parameter specifies the output current at DC braking and is a percentage relative to the motor rated current. The larger the value is, the stronger the DC braking effects, but the more heat the motor and frequency inverter emit.

● b1-11 (Stop DC braking time)

This parameter specifies the holding time of DC braking. If it is set to 0, DC braking is cancelled. The stop DC braking process is shown in the following figure.

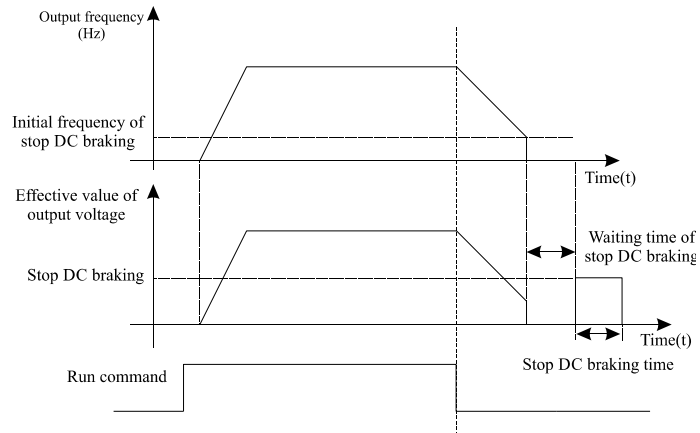

Diagram 5-5 Stop DC braking process

5.3 Group b2: Auxiliary Functions

Code	Parameter Name	Setting Range	Default
b2-00	JOG running frequency	0.00 Hz ~ maximum frequency	6.00 Hz
b2-01	JOG acceleration time	0.0s~6500.0s	Model dependent
b2-02	JOG deceleration time	0.0s~6500.0s	Model dependent

These parameters are used to define the set frequency and acceleration/deceleration time of the frequency inverter when jogging. The startup mode is fixed as "Direct start" (b1-00 = 0) and the stop mode is fixed as "Decelerate to stop" (b1-07 = 0) during jogging.

Code	Parameter Name	Setting Range	Default
b2-03	Acceleration time 2	0.0s~6500.0s	Model dependent
b2-04	Deceleration time 2	0.0s~6500.0s	Model dependent
b2-05	Acceleration time 3	0.0s~6500.0s	Model dependent
b2-06	Deceleration time 3	0.0s~6500.0s	Model dependent
b2-07	Acceleration time 4	0.0s~6500.0s	Model dependent
b2-08	Deceleration time 4	0.0s~6500.0s	Model dependent

The EM11 provides a total of four groups of acceleration/deceleration time, that is, the above three groups and the group b0-21 and b0-22. Definitions of four groups are completely the same, for more details, see the description of b0-21 and b0-22. You can switch over between the four groups of acceleration/deceleration time through different state combinations of DI terminals. For more details, see the descriptions of b3-01 to b3-011.

Code	Parameter Name	Setting Range	Default
b2-09	Jump frequency 1	0.00 Hz ~ maximum frequency	0.00 Hz
b2-10	Jump frequency 2	0.00 Hz ~ maximum frequency	0.00 Hz
b2-11	Frequency jump amplitude	0.00 Hz ~ maximum frequency	0.00Hz

If the setting frequency is within the jump frequency range, the actual running frequency is the jump frequency close to the set frequency. Setting the jump frequency helps to avoid the mechanical resonance point of the load.

The EM11 supports two jump frequencies. If both are set to 0, the frequency jump function is disabled. The principle of the jump frequencies and jump amplitude is shown in the following figure 6-6.

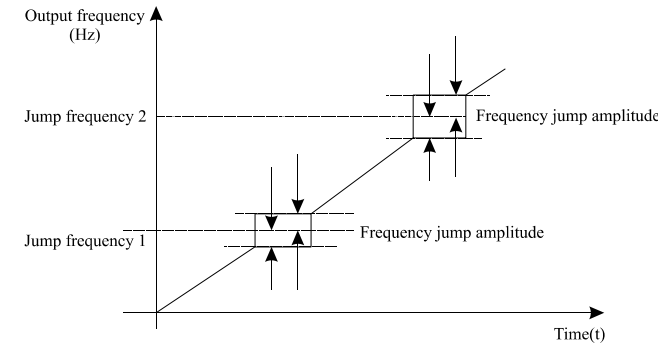

Diagram 5-6 Principle of the jump frequencies and jump amplitude

Code	Parameter Name	Setting Range	Default
b2-12	Jump frequency during acceleration/ deceleration	0: Disabled 1: Enabled	0.00Hz

It is used to set whether the jump frequencies are valid during acceleration/deceleration.

When the jump frequencies are valid during acceleration/deceleration, and the running frequency is within the frequency jump range, the actual running frequency will jump over the set frequency jump amplitude (rise directly from the lowest jump frequency to the highest jump frequency). The following figure shows the diagram when the jump frequencies are valid during acceleration/deceleration.

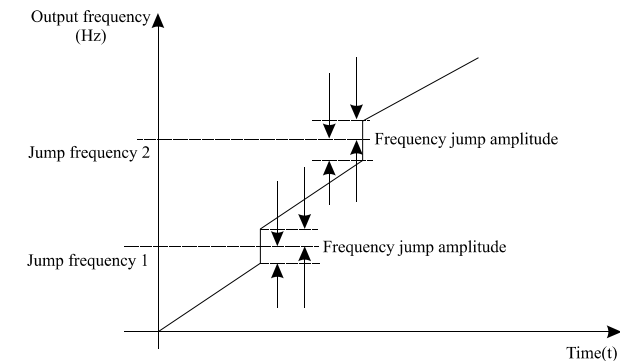

Diagram 5-7 Diagrams when the jump frequencies are valid during acceleration/deceleration

Code	Parameter Name	Setting Range	Default
b2-13	Frequency switchover point between acceleration time 1 and acceleration time 2	0.00 Hz ~ maximum frequency	0.00 Hz
b2-14	Frequency switchover point between deceleration time 1 and deceleration time 2	0.00 ~ maximum frequency	0.00 Hz

This function is valid when motor 1 is selected and acceleration/deceleration time switchover is not performed by means of DI terminal. It is used to select different groups of acceleration/ deceleration time based on the running frequency range rather than DI terminal during the running process of the frequency inverter.

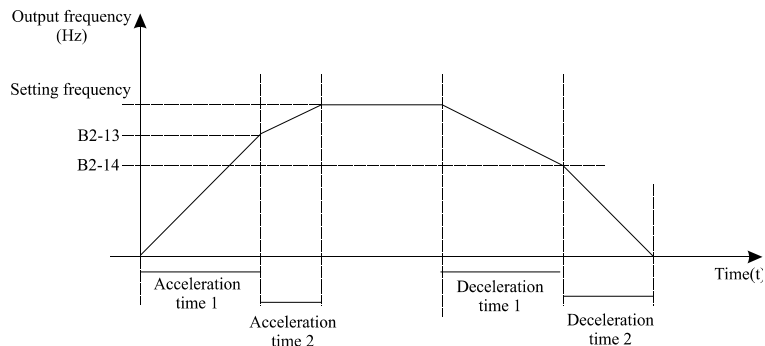

Diagram 5-8 Acceleration/deceleration time switchover

During acceleration, if the running frequency is smaller than the value of b2-13, acceleration time 1 is selected. If the running frequency is larger than the value of b2-13, acceleration time 2 is selected.

During deceleration, if the running frequency is larger than the value of b2-14, deceleration time 1 is selected. If the running frequency is smaller than the value of b2-14, deceleration time 2 is selected.

Code	Parameter Name	Setting Range	Default
b2-15	Reverse running	0: Enabled 1: Disabled	0

It is used to set whether the frequency inverter allows reverse rotation. In the applications where reverse rotation is prohibited, set this parameter to 1.

Code	Parameter Name	Setting Range	Default
b2-16	Forward/Reverse rotation dead-zone time	0.0~3000.0s	0.0s

It is used to set the time when the output is 0 Hz at transition of the frequency inverter forward rotation and reverse rotation, as shown in the following figure.

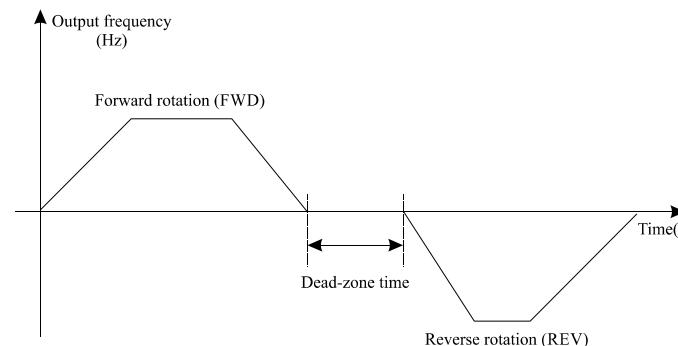

Diagram 5-9 Forward/Reverse rotation dead-zone time

Code	Parameter Name	Setting Range	Default
b2-17	Running mode when set frequency lower than frequency lower limit	0: Run at frequency lower limit 1: Stop 2: Run at zero speed	0

It is used to set the frequency inverter running mode when the set frequency is lower than the frequency lower limit. The EM11 provides three running modes to satisfy requirements of various applications.

Code	Parameter Name	Setting Range	Default
b2-18	Droop control	0.00Hz~10.00 Hz	0.00 Hz

This function is used for balancing the workload allocation when multiple motors are used to drive the same load. The output frequency of the frequency inverters decreases as the load increases. You can reduce the workload of the motor under load by decreasing the output frequency for this motor, implementing workload balancing among multiple motors.

Code	Parameter Name	Setting Range	Default
b2-19	Terminal JOG priority	0: Disabled 1: Enabled	0

It is used to set whether terminal JOG is priority.

If terminal JOG is priority, the frequency inverter switches to terminal JOG running state when there is a terminal JOG command during the running process of the frequency inverter.

Code	Parameter Name	Setting Range	Default
b2-20	Setting power-on time reach threshold	0~65000 h	0 h

If the accumulative power-on time (b9-08) reaches the value set in this parameter, the corresponding DO terminal output ON signal.

For example, combining virtual DI/DO functions, to implement the function that the frequency inverter reports an alarm when the actual accumulative power-on time reaches the threshold of 100 hours, perform the setting as follows:

1. Set virtual DI1 to user-defined fault 1: b7-00 = 40.
2. Set that the valid state of virtual DI1 is from virtual DO1: b7-05 = 0000.
3. Set virtual DO1 to power-on time reached: b7-11 = 25.
4. Set the accumulative power-on time reach threshold to 100 h: b2-20 = 100 h.

Then, the frequency inverter alarm output Err27 when the accumulative power-on time reaches 100 hours.

Code	Parameter Name	Setting Range	Default
b2-21	Setting running time reach threshold	0~65000 h	0 h

It is used to set the accumulative running time threshold of the Frequency inverter. If the accumulative running time (b9-09) reaches the value set in this parameter, the corresponding DO terminal becomes ON.

Code	Parameter Name	Setting Range	Default
b2-22	Action after running time reached	0: Continue to run 1: Stop	0

This function is used to define the action after b2-21 preset time reached. Setting 0 inverter will continue work after present running time reached; and set 1, the inverter will stop.

Code	Parameter Name	Setting Range	Default
b2-23	Cooling fan control	0: Fan working during running 1: Fan working during power on	0

It is used to set the working mode of the cooling fan. If this parameter is set to 0, the fan works when the frequency inverter is in running state. When the frequency inverter stops, the cooling fan works if the heatsink temperature is higher than 40°C, and stops working if the heatsink temperature is lower than 40°C. If this parameter is set to 1, the cooling fan keeps working after power-on.

Code	Parameter Name	Setting Range	Default
b2-24	Dormant frequency	0.00Hz ~wakeup frequency (b2-26)	0.00 Hz
b2-25	Dormant delay time	0.0s~6000.0s	0.0s
b2-26	Wakeup frequency	Dormant frequency (b2-24)~ maximum frequency (b0-13)	0.00 Hz
b2-27	Wakeup delay time	0.0s~6000.0s	0.0s

These parameters are used to implement the dormant and wakeup functions in the water supply application. When the frequency inverter is in running state, the frequency inverter enters the dormant state and stops automatically after the dormant delay time (b2-25) if the set frequency is lower than or equal to the dormant frequency (b2-24).

When the frequency inverter is in dormant state and the present running command is effective, the frequency inverter starts up after the wakeup delay time (b2-27) if the set frequency is higher than or equal to the wakeup frequency (b2-26).

Generally, set the wakeup frequency should be equal to or higher than the dormant frequency. If the wakeup frequency and dormant frequency are set to 0, the dormant and wakeup functions are disabled.

When the dormant function is enabled, if the frequency source is PID, whether PID operation is performed in the dormant state is determined by C0-27. In this case, select PID operation enabled in the stop state (C0-27 = 1).

Code	Parameter Name	Setting Range	Default
b2-28	Timing function	0: Disabled 1: Enabled	0
b2-29	Timing duration source	0: b2-30 1: AI1 2: AI2 3: AI3 (100% of analog input corresponds to the value of b2-30)	0
b2-30	Timing duration	0.0min~6500.0 min	0.0 min

These parameters are used to implement the frequency inverter timing function.

If b2-28 is set to 1, the frequency inverter starts to time at startup. When the set timing duration reached, the frequency inverter stops automatically, and meanwhile the corresponding DO outputs ON signal.

The frequency inverter starts timing from 0.0min each time it starts up and the remaining timing duration can be checked by U0-20.

The timing duration is set in b2-29 and b2-30, in unit of minute.

Code	Parameter Name	Setting Range	Default
b2-31	This time running time reached threshold	0.0min~6500.0 min	0.0 min

If the present running time reaches the value set in this parameter, the corresponding DO outputs ON signal, indicating that present running time is reached.

Code	Parameter Name	Setting Range	Default
b2-32	Startup protection	0: No 1: Yes	0

This parameter is used to enable the frequency inverter safety protection. If it is set to 1, the frequency inverter does not respond to the run command after power-on (for example, an input terminal is ON before power-on). The frequency inverter responds only after the run command is cancelled and becomes valid again.

In addition, the frequency inverter does not respond to the run command valid from fault reset of the frequency inverter. The run protection can be disabled only after the run command is cancelled one time.

In this way, the motor will not automatically startup to avoid unexpected dangerous conditions for these startup commands from power-on and fault reset.

5.4 Group b3: Input Terminals

The EM11 provides six digital input (DI) terminals (DI6 can be used for high-speed pulse input) and two analog input (AI) terminals. The optional extension card provides another six DI terminals (DI7 to DI12) and one AI terminal (AI3).

Code	Parameter Name	Setting Range	Default
b3-00	DI1 function selection	1: Forward RUN (FWD)	Standard
b3-01	DI2 function selection	4: Forward JOG (FJOG)	Standard
b3-02	DI3 function selection	9: Multi-function terminal 4	Standard
b3-03	DI4 function selection	12: clear to zero of UP and DOWN setting (terminal, keypad)	Standard
b3-04	DI5 function selection	13: Terminal 1 for acceleration/ deceleration time selection	Standard
b3-05	DI6/HDI function selection	32: Pulse input (enabled only for HDI)	Standard
b3-06	DI7 function selection	0	Extended
b3-07	DI8 function selection	0	Extended
b3-08	DI9 function selection	0	Extended
b3-09	DI10 function selection	0	Extended
b3-10	DI11 function selection	0	Extended
b3-11	DI12 function selection	0	Extended

The following table lists the functions available for the DI terminals.

Table 6-1 Functions of DI terminals

Value	Function	Description
0	No function	Set 0 for reserved terminals to avoid malfunction.
1	Forward RUN (FWD) or running command	The terminal is used to control forward or reverse running of the frequency inverter.
2	Reverse RUN (REV) or the direction of FED/REV	
3	Three-line control	The terminal determines three-line control of the frequency inverter. For details, see the description of b3-13.
4	Forward JOG (FJOG)	FJOG indicates forward JOG running, while RJOG indicates reverse JOG running. The JOG frequency, acceleration time and deceleration time are described respectively in b2-00, b2-01 and b2-02.
5	Reverse JOG (RJOG)	

Value	Function	Description
6	Multi-function terminal 1	The setting of 16 speeds or 16 other references can be implemented through combinations of 16 states of these four terminals.
7	Multi-function terminal 2	
8	Multi-function terminal 3	
9	Multi-function terminal 4	
10	Terminal UP	If the frequency is determined by external terminals, the terminals with the two functions are used as increment and decrement commands for frequency modification. When the frequency source is digital setting, they are used to adjust the frequency.
11	Terminal DOWN	
12	UP and DOWN setting clear (terminal, operation panel)	If the frequency source is digital setting, the terminal is used to clear the modification by using the UP/ DOWN function or the increment/decrement key on the operation panel, returning the set frequency to the value of b0-12.
13	Terminal 1 for acceleration/deceleration time selection	Totally four groups of acceleration/deceleration time can be selected through combinations of two states of these two terminals.
14	Terminal 2 for acceleration/deceleration time selection	
15	Frequency source switchover	The terminal is used to perform switchover between two frequency sources according to the setting in b0-07.
16	Switchover between main frequency source X and preset frequency	After this terminal becomes ON, the frequency source X is replaced by the preset frequency (b0-12).
17	Switchover between auxiliary frequency source Y and preset frequency	After this terminal is enabled, the frequency source Y is replaced by the preset frequency (b0-12).
18	Terminal 1 for Command source switchover	If the command source is set to terminal control (b0-02 = 1), this terminal is used to perform switchover between terminal control and operation panel control. If the command source is set to communication control (b0-02 = 2), this terminal is used to perform switchover between communication control and operation panel control.
19	Terminal 2 for Command source switchover	It is used to perform switchover between terminal control and communication control. If the command source is terminal control, the system will switch over to communication control after this terminal becomes ON.
20	Speed control/Torque control switchover	This terminal enables the frequency inverter to switch over between speed control and torque control. When this terminal becomes OFF, the frequency inverter runs in the mode set in d1-00. When this terminal becomes ON, the frequency inverter switches over to the other control mode.
21	Torque control prohibited	The Frequency inverter is prohibited from torque control and enters the speed control mode.
22	PID pause	PID is invalid temporarily. The frequency inverter maintains the present frequency output without supporting PID adjustment of frequency source.
23	PID integral pause	After this terminal becomes ON, the integral adjustment function pauses. However, the proportional and differentiation adjustment functions are still valid.
24	Reverse PID action direction	After this terminal becomes ON, the PID action direction is reversed to the direction set in C0-04.
25	PID parameter switchover	If the PID parameters switchover performed by means of DI terminal (C0-12 = 1). When the terminal becomes OFF; the PID parameters are C0-06~C0-08; when this terminal becomes ON, the PID parameters switch to C0-09 ~ C0-11.

Value	Function	Description
26	PLC status reset	The terminal is used to restore the original status of PLC control for the frequency inverter when PLC control is started again after a pause.
27	Swing frequency pause	The frequency inverter outputs the central frequency, and the swing frequency function pauses.
28	Counter input	This terminal is used to count pulses.
29	Counter reset	This terminal is used to clear the counter status.
30	Length count input	This terminal is used to count the length.
31	Length reset	This terminal is used to clear the length.
32	Pulse input (enabled only for DI6/HDI)	DI6 is used for pulse input.
33	Frequency modification forbidden	After this terminal becomes ON, the frequency inverter does not respond to any frequency modification.
34	Acceleration/Deceleration prohibited	It enables the frequency inverter to maintain the present frequency output without being affected by external signals (except the STOP command).
35	Motor selection terminal 1	Switchover among the two groups of motor parameters can be implemented through this terminal.
36	Motor selection terminal 2 (Reserved)	Reserved.
37	Fault reset (RESET)	The terminal is used for fault reset function, the same as the function of RESET key on the operation panel. Remote fault reset is implemented by this function.
38	Normally open (NO) input of external fault	If this terminal becomes ON, the frequency inverter reports Err15 and performs the fault protection action. For more details, see the description of bb-32.
39	Normally closed (NC) input of external fault	After this terminal becomes ON, the frequency inverter reports Err15 and performs the fault protection action. For more details, see the description of bb-32.
40	User-defined fault 1	If these two terminals become ON, the frequency inverter reports Err27 and Err28 respectively, and performs fault protection actions based on the setting in bb-34.
41	User-defined fault 2	
42	RUN pause	The frequency inverter decelerates to stop, but the running parameters are all memorized, such as PLC, swing frequency and PID parameters. After this function is disabled, the frequency inverter restore to its status before stop.
43	Free stop	The frequency inverter blocks its output, the motor free stop and is not controlled by the frequency inverter. It is the same as free stop described in b1-07.
44	Emergency stop	When this terminal becomes ON, the frequency inverter stops within the shortest time. During the stop process, the current remains at the set current upper limit. This function is used to satisfy the requirement of stopping the frequency inverter in emergency state.
45	External STOP terminal 1	In operation keypad mode, this terminal can be used to stop the frequency inverter, equivalent to the function of the STOP key on the operation keypad.
46	External STOP terminal 2	In any control mode (operation panel, terminal or communication), it can be used to make the frequency inverter decelerate to stop. In this case, the deceleration time is deceleration time 4.
47	Deceleration DC braking	When this terminal becomes ON, the frequency inverter decelerates to the initial frequency of DC braking and then switches over to DC braking state.

Value	Function	Description
48	Immediate DC braking	After this terminal becomes ON, the frequency inverter directly switches over to the DC braking state.
49	Clear this time running time	When this terminal becomes ON, the frequency inverter's this time running time is cleared. This function must be supported by b2-28 and b2-31.

The four multi-function terminals have 16 state combinations, corresponding to 16 reference values, as listed in the following table.

K4	K3	K2	K1	Reference Setting	Corresponding Parameter
OFF	OFF	OFF	OFF	Reference 0	C1-00
OFF	OFF	OFF	ON	Reference 1	C1-01
OFF	OFF	ON	OFF	Reference 2	C1-02
OFF	OFF	ON	ON	Reference 3	C1-03
OFF	ON	OFF	OFF	Reference 4	C1-04
OFF	ON	OFF	ON	Reference 5	C1-05
OFF	ON	ON	OFF	Reference 6	C1-06
OFF	ON	ON	ON	Reference 7	C1-07
ON	OFF	OFF	OFF	Reference 8	C1-08
ON	OFF	OFF	ON	Reference 9	C1-09
ON	OFF	ON	OFF	Reference 10	C1-10
ON	OFF	ON	ON	Reference 11	C1-11
ON	ON	OFF	OFF	Reference 12	C1-12
ON	ON	OFF	ON	Reference 13	C1-13
ON	ON	ON	OFF	Reference 14	C1-14
ON	ON	ON	ON	Reference 15	C1-15

If the frequency source is multi-function, the value 100% of C1-00~ C1-15 corresponds to the value of b0-13 (Maximum frequency).

Besides as the multi-speed function, the multi-function can be also used as the PID setting source or the voltage source for V/F separation, satisfying the requirement on switchover of different setting values.

Table 5-2 Function description of Acceleration/Deceleration time selection terminals

Terminal 2	Terminal 1	Acceleration/Deceleration Time	Corresponding
OFF	OFF	Acceleration/Deceleration time 1	b0-21, b0-22
OFF	ON	Acceleration/Deceleration time 2	b2-03, b2-04
ON	OFF	Acceleration/Deceleration time 3	b2-05, b2-06
ON	ON	Acceleration/Deceleration time 4	b2-07, b2-08

Table 5-3 Function description of motor selection terminals

Terminal 1	Selected Motor	Corresponding Parameters
OFF	Motor 1	Group d0, Group d1, Group d2
ON	Motor 2	Group d3, Group d4, Group d5

Code	Parameter Name	Setting Range	Default
b3-12	DI filter time	0.000s~1.000s	0.010s

It is used to set the software filter time of DI terminal status. If DI terminals are liable to interference and may cause malfunction, increase the value of this parameter to enhance the anti-interference capability. However, increase of DI filter time will slow down the response of DI terminals.

Code	Parameter Name	Setting Range	Default
b3-13	Terminal command mode	0: Two-line mode 1 1: Two-line mode 2 2: Three-line mode 1 3: Three-line mode 2	0

This parameter is used to set the mode in which the frequency inverter is controlled by external terminals. The following uses DI1, DI2 and DI3 among DI1 to DI12 as an example, with allocating functions of DI1, DI2 and DI3 by setting b3-00 to b3-02.

0: Two-line mode 1

It is the most commonly used two-line mode, in which the forward/reverse rotation of the motor is decided by DI1 and DI2. The parameters are set as below:

Code	Name	Value	Function Description
b3-13	Terminal command mode	0	Two-line 1
b3-00	DI1 function selection	1	Forward RUN (FWD)
b3-01	DI2 function selection	2	Reverse RUN (REV)

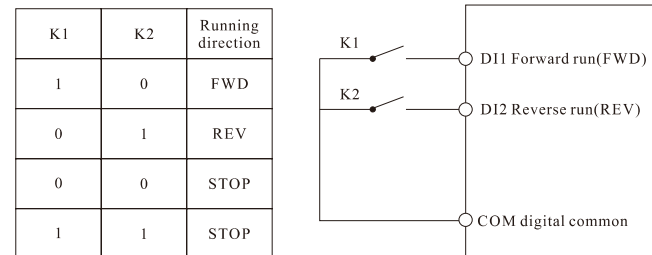

Diagram 5-10 Setting of two-line mode 1

As shown in the preceding figure, when only K1 is ON, the frequency inverter instructs forward rotation. When only K2 is ON, the frequency inverter instructs reverse rotation. When K1 and K2 are ON or OFF simultaneously, the frequency inverter stops.

1: Two-line mode 2

In this mode, DI1 is RUN enabled terminal, and DI2 determines the running direction. The parameters are set as below:

Code	Name	Value	Function Description
b3-13	Terminal command mode	1	Two-line 2
b3-00	DI1 function selection	1	RUN enabled
b3-01	DI2 function selection	2	Forward or reverse

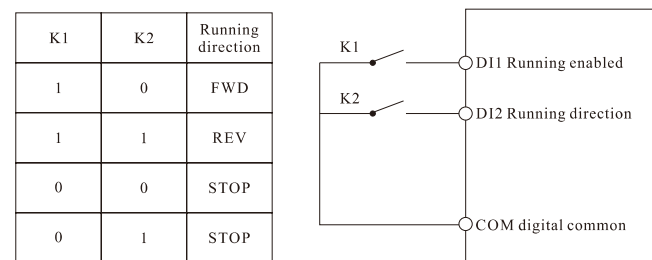

Diagram 5-11 Setting of two-line mode 2

As shown in the preceding figure, if K1 is ON, the frequency inverter instructs forward rotation when K2 is OFF, and instructs reverse rotation when K2 is ON. If K1 is OFF, the Frequency inverter stops.

2: Three-line mode 1

In this mode, DI3 is RUN enabled terminal, and the direction is decided by DI1 and DI2. The parameters are set as below:

Code	Name	Value	Function Description
b3-13	Terminal command mode	2	Three-line 1
b3-00	DI1 function selection	1	Forward RUN (FWD)
b3-01	DI2 function selection	2	Reverse RUN (REV)
b3-02	DI3 function selection	3	Three-line control

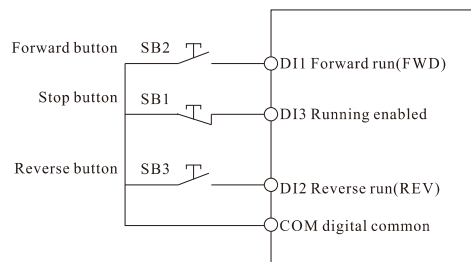

Diagram 5-12 Setting of three-line mode 1

As shown in the preceding figure, if SB1 is ON, the frequency inverter instructs forward rotation when SB2 is pressed to be ON, and instructs reverse rotation when SB3 is pressed to be ON. The frequency inverter stops immediately after SB1 becomes OFF. During normal startup and running, SB1 must remain ON. The frequency inverter's running state is determined by the final actions on SB1, SB2 and SB3.

3: Three-line mode 2

In this mode, DI3 is RUN enabled terminal. The RUN command is given by DI1 and the direction is decided by DI2. The parameters are set as below:

Code	Name	Value	Function Description
b3-13	Terminal command mode	3	Three-line 2
b3-00	DI1 function selection	1	RUN enabled
b3-01	DI2 function selection	2	Forward or reverse
b3-02	DI3 function selection	3	Three-line control

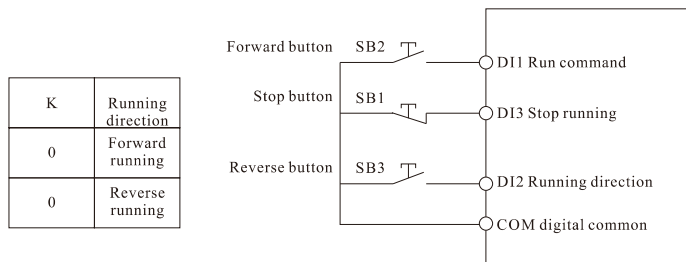

Diagram 5-13 Setting of three-line mode 2

As shown in the preceding figure, if SB1 is ON, the frequency inverter starts running when SB2 is pressed to be ON; the frequency inverter instructs forward rotation when K is OFF and instructs reverse rotation when K is ON. The Frequency inverter stops immediately after SB1 becomes OFF. During normal startup and running, SB1 must remain ON, SB2 is effective immediately after ON action.

Code	Parameter Name	Setting Range	Default
b3-14	Terminal UP/DOWN rate	0.001Hz/s~65.535 Hz/s	0.100 Hz/s

It is used to adjust the ratio of changing of frequency for per second when the frequency is adjusted by means of terminal UP/ DOWN.

- If b0-11 (Frequency reference resolution) is 2, the setting range is 0.001Hz/s~65.535 Hz/s.
- If b0-11 (Frequency reference resolution) is 1, the setting range is 0.01Hz/s~655.35 Hz/s.

Code	Parameter Name	Setting Range	Default
b3-15	DI1 ON delay time	0.0s~3000.0s	0.0s
b3-16	DI1 OFF delay time	0.0s~3000.0s	0.0s
b3-17	DI2 ON delay time	0.0s~3000.0s	0.0s
b3-18	DI2 OFF delay time	0.0s~3000.0s	0.0s
b3-19	DI3 ON delay time	0.0s~3000.0s	0.0s
b3-20	DI3 OFF delay time	0.0s~3000.0s	0.0s
b3-21	DI4 ON delay time	0.0s~3000.0s	0.0s
b3-22	DI4 OFF delay time	0.0s~3000.0s	0.0s
b3-23	DI5 ON delay time	0.0s~3000.0s	0.0s
b3-24	DI5 OFF delay time	0.0s~3000.0s	0.0s

These parameters are used to set the delay time of the frequency inverter when the status of DI terminals changes.

The DI1 to DI5 support the delay time function.

Code	Parameter Name	Setting Range	Default
b3-25	DI valid selection 1	Unit's digit: DI1 valid mode. 0: Low level valid 1: High level valid Ten's digit: DI2 valid mode. 0, 1 (same as DI1) Hundred's digit: DI3 valid mode. 0, 1 (same as DI1) Thousand's digit: DI4 valid mode. 0, 1 (same as DI1) Ten thousand's digit: DI5 valid mode. 0, 1 (same as DI1)	00000
b3-26	DI valid selection 2	Unit's digit: DI6 valid mode. 0, 1 (same as DI1) Ten's digit: DI7 valid mode. 0, 1 (same as DI1) Hundred's digit: DI8 state. 0, 1 (same as DI1) Thousand's digit: DI9 valid mode. 0, 1 (same as DI1) Ten thousand's digit: DI10 valid mode. 0, 1 (same as DI1)	00000

These parameters are used to set the valid mode of DI terminals.

0: Low level valid

The DI terminal is invalid when being connected with COM, and valid when being disconnected from COM.

1: High level valid

The DI terminal is valid when being connected with COM, and invalid when being disconnected from COM.

5.5 Group b4: Output Terminals

The EM11 provides an analog output (AO) terminal, a digital output (DO) terminal, a relay terminal and a

FM terminal (used for high-speed pulse output or open-collector switch signal output) as standard. If these output terminals cannot satisfy requirements, use an optional I/O extension card.

Code	Parameter Name	Setting Range	Default
b4-00	FM terminal output mode	0: Pulse output (FMP) 1: Switch signal output (FMR)	1

The FM terminal is programmable multiplexing terminal. It can be used for high-speed pulse output (FMP), with maximum frequency of 100 kHz. Refer to b6-00 for relevant functions of FMP. It can also be used as open collector switch signal output (FMR).

Code	Parameter Name	Default
b4-01	FMR function (open- collector output terminal)	0
b4-02	Relay 1 function (TA-TB-TC)	2
b4-03	Reserved	
b4-04	DO1 function selection (open-collector output terminal)	1
b4-05	DO2 function(extend)	0
b4-06	DO3 function(extend)	0
b4-07	DO4 function(extend)	0
b4-08	DO5 function(extend)	0
b4-09	DO6 function(extend)	0

These nine parameters are used to select the functions of the nine digital output terminals. TA-TB-TC and P/A-P/B-P/C are respectively the relays on the control board and the extension card.

The functions of the output terminals are described in the following table.

Value	Function	Description
0	No output	The terminal has no function.
1	Ready for RUN	If the frequency inverter main circuit and control circuit become stable, and the frequency inverter detects no fault and is ready for RUN, the terminal becomes ON.
2	Frequency inverter running	When the frequency inverter is running and has output frequency (can be zero), the terminal becomes ON.
3	Fault output (free stop)	When the frequency inverter stops due to a fault, the terminal becomes ON.
4	Fault output(free stop fault, no output at under-voltage)	
5	Swing frequency limited	If the set frequency exceeds the frequency upper limit or lower limit and the output frequency of the frequency inverter reaches the upper limit or lower limit, the terminal becomes ON.
6	Torque limited	In speed control mode, if the output torque reaches the torque limit, the frequency inverter enters the stall protection state and meanwhile the terminal becomes ON.
7	Frequency upper limit reached	If the running frequency reaches the upper limit, the terminal becomes ON.
8	Frequency lower limit reached (no output at	If the running frequency reaches the lower limit, the terminal becomes ON. In the stop state, the terminal becomes OFF.
9	Frequency lower limit reached (having output at stop)	If the running frequency reaches the lower limit, the terminal becomes ON. In the stop state, the signal is still ON.
10	Reverse running	If the frequency inverter is in the reverse running state, the terminal becomes ON.

Value	Function	Description
11	Zero-speed running (no output at stop)	If the frequency inverter runs with the output frequency of 0, the terminal becomes ON. If the frequency inverter is in the stop state, the terminal becomes OFF.
12	Zero-speed running 2 (having output at stop)	If the output frequency of the frequency inverter is 0, the terminal becomes ON. In the state of stop, the signal is still ON.
13	Set count value reached	The terminal becomes ON when the count value reaches the value set in C3-08.
14	Designated count value reached	The terminal becomes ON when the count value reaches the value set in C3-09.
15	Length reached	The terminal becomes ON when the detected actual length exceeds the value set in C3-05.
16	PLC cycle complete	When simple PLC completes one cycle, the terminal outputs a pulse signal with width of 250ms.
17	Frequency-level detection FDT1 output	Refer to the descriptions of b4-22 and b4-23.
18	Frequency level detection FDT2 output	Refer to the descriptions of b4-24 and b4-25.
19	Frequency reached	Refer to the descriptions of b4-26.
20	Frequency 1 reached	Refer to the descriptions of b4-27 and b4-28.
21	Frequency 2 reached	Refer to the descriptions of b4-29 and b4-30.
22	Current 1 reached	Refer to the descriptions of b4-35 and b4-36.
23	Current 2 reached	Refer to the descriptions of b4-37 and b4-38.
24	Module temperature reached	If the heatsink temperature of the inverter module (b9-07) reaches the set module temperature threshold (b4-39), the terminal becomes ON.
25	Timing reached	If the timing function (b2-28) is valid, the terminal becomes ON after the present running time of the frequency inverter reaches the set time.
26	Zero current state	Refer to the descriptions of b4-24 and b4-25.
27	Output current limit exceeded	Refer to the descriptions of b4-33 and b4-34.
28	Lower voltage state output	If the frequency inverter is in lower voltage state, the terminal becomes ON.
29	Frequency inverter overload pre-warning	The frequency inverter judges whether the motor load exceeds the overload pre-warning threshold before performing the protection action. If the pre-warning threshold is exceeded, the terminal becomes ON. For motor overload parameters, see the descriptions of bb-01 to bb-03.
30	Motor overheat warning	If the motor temperature reaches the temperature set in bb-27 (Motor overheat warning threshold), the terminal becomes ON. You can view the motor temperature by using U0-33.
31	Motor overload pre-warning	The frequency inverter judges motor overload according to preset motor overload threshold, and terminal becomes ON. The overload threshold setting refer to bb-01~bb-03.
32	Off load	If the load becomes 0, the terminal becomes ON.
33	A11 larger than A12	When the input of A11 is larger than the input of A12, the terminal becomes ON.
34	A11 input limit exceeded	If A11 input is larger than the value of b5-06 (A11 input voltage upper limit) or lower than the value of b5-05 (A11 input voltage lower limit), the terminal becomes ON.

Value	Function	Description
35	Alarm output (all faults)	If a fault occurs on the frequency inverter and the frequency inverter continues to run, the terminal outputs the alarm signal.
36	This time running time reached	If the current running time of frequency inverter exceeds the value of b2-31, the terminal becomes ON.
37	Accumulative power-on time reached	If the frequency inverter accumulative power-on time (b9-08) exceeds the value set in b2-20, the terminal becomes ON.
38	Accumulative running time reached	If the accumulative running time of the frequency inverter exceeds the time set in b2-21, the terminal becomes ON.

Code	Parameter Name	Setting Range	Default
b4-10	FMR ON delay time	0.0s~3000.0s	0.0s
b4-11	FMR OFF delay time	0.0s~3000.0s	0.0s
b4-12	Relay 1 ON delay time	0.0s~3000.0s	0.0s
b4-13	Relay 1 OFF delay time	0.0s~3000.0s	0.0s
b4-14	Reserved		
b4-15	Reserved		
b4-16	DO1 ON delay time	0.0s~3000.0s	0.0s
b4-17	DO1 OFF delay time	0.0s~3000.0s	0.0s
b4-18	DO2 ON delay time	0.0s~3000.0s	0.0s
b4-19	DO2 OFF delay time	0.0s~3000.0s	0.0s

These parameters are used to set the delay time of output terminals FMR, relay, DO1, DO2 and DO3 from status change to actual output.

Code	Parameter Name	Setting Range	Default
b4-20	DO logic selection 1	Unit's digit: FMR valid mode. 0: Positive logic 1: Negative logic Ten's digit: Relay 1 valid mode. 0, 1 (same as FMR) Hundred's digit: Relay 2 valid mode. 0, 1 (same as FMR) Thousand's digit: DO1 valid mode. 0, 1 (same as FMR) Ten thousand's digit: DO2 valid mode. 0, 1 (same as FMR)	00000

It is used to set the logic of output terminals FMR, relay, DO1 and DO2.

0: Positive logic

The output terminal is valid when being connected with COM, and invalid when being disconnected from COM.

1: Negative logic

The output terminal is invalid when being connected with COM, and valid when being disconnected from COM.

Code	Parameter Name	Setting Range	Default
b4-22	Frequency detection value (FDT1)	0.00 Hz~ maximum frequency	50.00 Hz
b4-23	Frequency detection hysteresis (FDT hysteresis 1)	0.0%~100.0% (FDT1 level)	5.0%

If the running frequency is higher than the value of b4-22, the corresponding DO terminal becomes ON. If

the running frequency is lower than value of b4-22, the DO terminal goes OFF.

These two parameters are respectively used to set the detection value of output frequency and hysteresis value of cancellation of the output. The value of b4-23 is a percentage of the hysteresis frequency to the frequency detection value (b4-22). The FDT function is shown in the following figure.

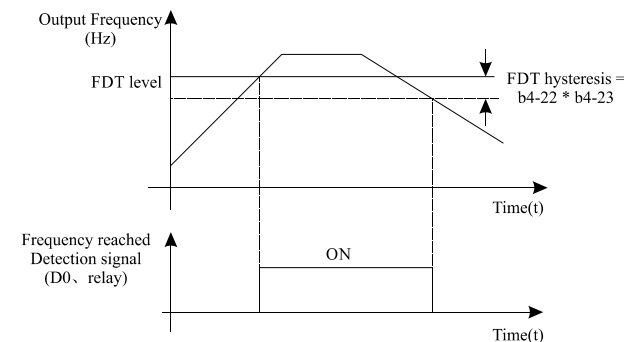

Diagram 5-14 FDT level

Code	Parameter Name	Setting Range	Default
b4-24	Frequency detection value (FDT2)	0.00Hz ~ maximum frequency	50.00 Hz
b4-25	Frequency detection hysteresis (FDT hysteresis 2)	0.0%~100.0% (FDT2 level)	5.0%

The frequency detection function is the same as FDT1 function. For details, refer to the descriptions of b4-22 and b4-23.

Code	Parameter Name	Setting Range	Default
b4-26	Detection amplitude of frequency reached	0.00~100% (maximum frequency)	3.0%

If the frequency inverter running frequency is within the certain range of the set frequency, the corresponding DO terminal becomes ON.

This parameter is used to set the range within which the output frequency is detected to reach the set frequency. The value of this parameter is a percentage relative to the maximum frequency. The detection range of frequency reached is shown in the following figure.

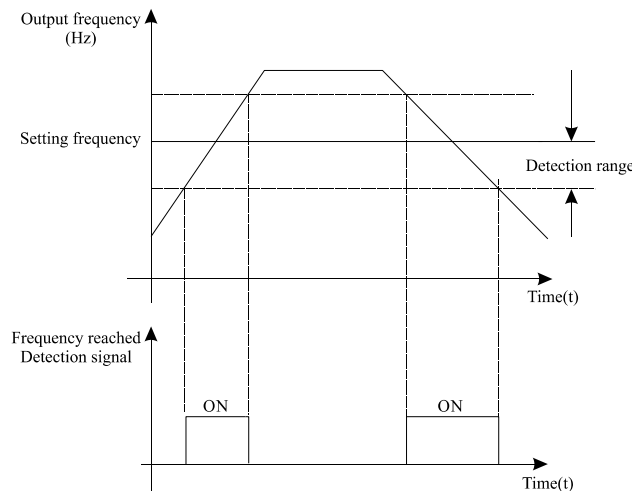

Diagram 5-15 Detection range of frequency reached

Code	Parameter Name	Setting Range	Default
b4-27	Any frequency reaching detection value 1	0.00 Hz ~ maximum frequency	50.00 Hz
b4-28	Any frequency reaching detection amplitude 1	0.0%~100.0% (maximum frequency)	3.0%
b4-29	Any frequency reaching detection value 2	0.00 Hz ~ maximum frequency	50.00 Hz
b4-30	Any frequency reaching detection amplitude 2	0.0%~100.0% (maximum frequency)	3.0%

If the output frequency of the frequency inverter is within the positive and negative amplitudes of the any frequency reaching detection value, the corresponding DO becomes ON.

The EM11 provides two groups of any frequency reaching detection parameters, including frequency detection value and detection amplitude, as shown in the following figure.

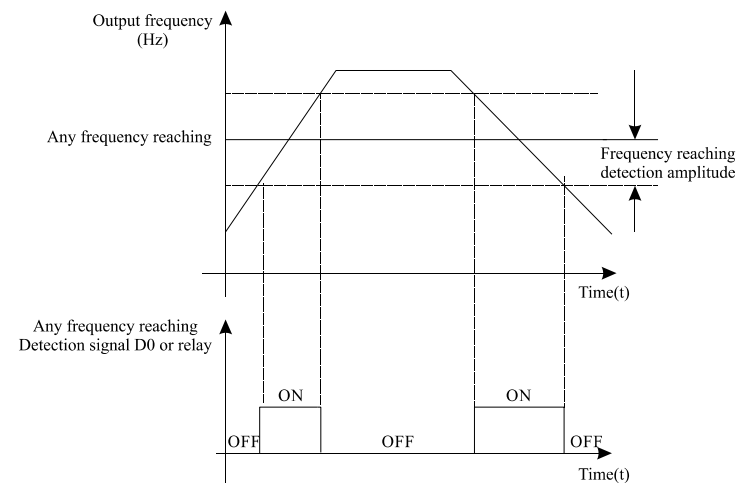

Diagram 5-16 Any frequency reaching detection

Code	Parameter Name	Setting Range	Default
b4-31	Zero current detection level	0.0%~100.0% (rated motor current)	5.0%
b4-32	Zero current detection delay time	0.00s~600.00s	0.10s

If the output current of the frequency inverter is equal to or less than the zero current detection level and the duration exceeds the zero current detection delay time, the corresponding DO becomes ON. The zero current detection is shown in the following figure.

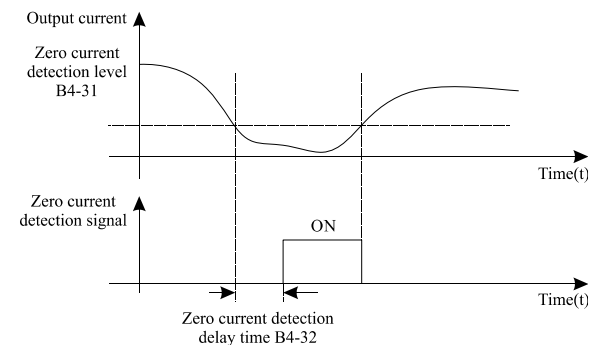

Diagram 5-17 Zero current detection

Code	Parameter Name	Setting Range	Default
b4-33	Over current output threshold	0.0%~300.0% (rated motor current)	200.0%
b4-34	Over current output detection delay time	0.00s~600.00s	0.10s

If the output current of the frequency inverter is equal to or higher than the over current threshold and the duration exceeds the detection delay time, the corresponding DO becomes ON. The output over current detection function is shown in the following figure.

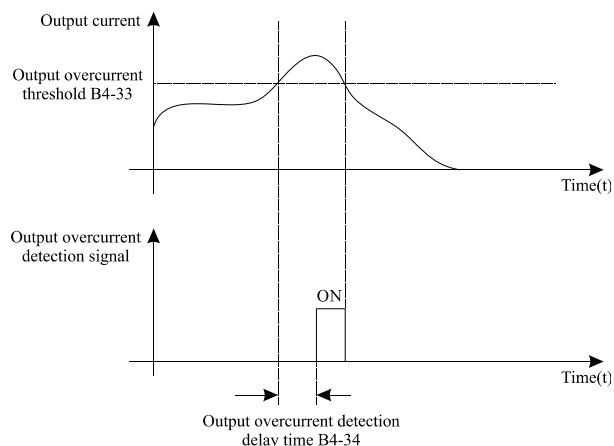

Diagram 5-18 Output over current detection

Code	Parameter Name	Setting Range	Default
b4-35	Any current reaching 1	0.0%~100.0% (rated motor current)	100.0%
b4-36	amplitude of any current reaching 1	0.0%~100.0% (rated motor current)	3.0%
b4-37	Any current reaching 2	0.0%~100.0% (rated motor current)	100.0%
b4-38	Amplitude of any current reaching 2	0.0%~100.0% (rated motor current)	3.0%

If the output current of the frequency inverter is within the positive and negative amplitudes of any current reaching detection value, the corresponding DO becomes ON.

The EM11 provides two groups of any current reaching detection parameters, including current detection value and detection amplitudes, as shown in the following figure.

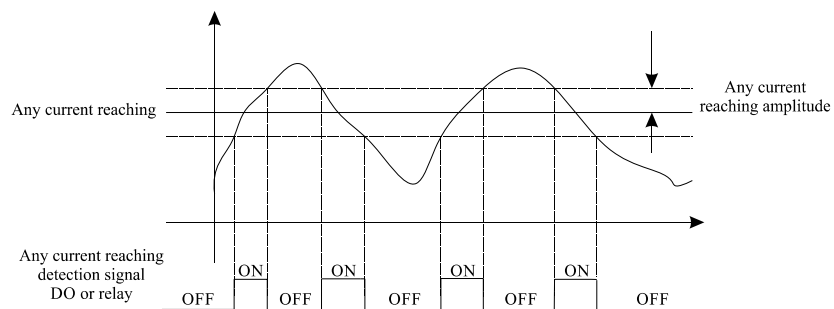

Diagram 5-19 Any current reaching detection

Code	Parameter Name	Setting Range	Default
b4-39	Module temperature threshold	25~100°C	75°C

When the heatsink temperature of the frequency inverter reaches the value of this parameter, the corresponding DO becomes ON, indicating that the IGBT module temperature reaches the threshold.

5.6 Group b5: Pulse/Analog input terminals

Code	Parameter Name	Setting Range	Default
b5-00	Pulse minimum input(HDI)	0.00 kHz ~b5-02	0.00 kHz
b5-01	Corresponding setting of pulse minimum input	-100.00% ~100.0%	0.00%
b5-02	Pulse maximum input	b5-00 ~ 50.00 kHz	50.00 kHz
b5-03	Corresponding setting of pulse maximum input	-100.00% ~100.0%	100.0%
b5-04	Pulse filter time	0.00s~10.00s	10.00s

Can only be input by DI6. The method of setting this function is similar to that of setting A11 function..

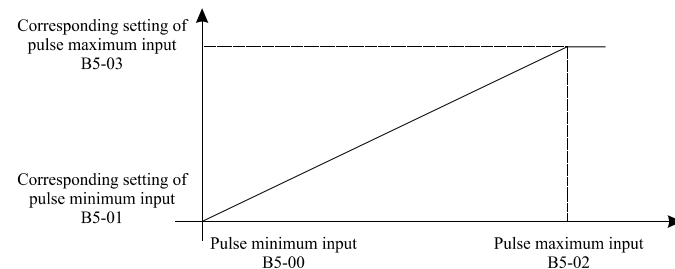

Diagram 5-20 The relationship between pulse input and setting value

Code	Parameter Name	Setting Range	Default
b5-05	A11 input voltage lower limit of protection	0.00 V~ b5-06	3.10 V
b5-06	A11 input voltage upper limit of protection	b5-05~10.00 V	6.80 V

These two parameters are used to set the limits of the input voltage to provide protection on the frequency inverter. When the A11 input is larger than the value of b5-06 or smaller than the value of b5-05, the corresponding DO becomes ON, indicating that A11 input exceeds the limit. Every analog input has five setting points to facilitate the setting of the AI curve.

Code	Parameter Name	Setting Range	Default
b5-07	A11 input minimum value	0.00 V ~ b5-15	0.00 V
b5-08	Corresponding setting of A11 minimum input	-100.00% ~100.0%	0.0%
b5-09	Second point input value of A11	0.00 V~10.00 V	2.50V
b5-10	Corresponding setting of second point input value of A11	-100.0% ~100.0%	25.0%
b5-11	Third point input value of A11	0.00 V~10.00 V	5.00V
b5-12	Corresponding setting of third point input value of A11	-100.0% ~100.0%	50.0%
b5-13	Fourth point input value of A11	0.00 V~10.00 V	7.50V
b5-14	Corresponding setting of	-100.0% ~100.0%	75.0%

Code	Parameter Name	Setting Range	Default
	fourth point input value of AI1		
b5-15	AI1 input maximum value	0.00 V ~ 10.00 V	10.00 V
b5-16	Corresponding setting of AI1 maximum input	-100.00% ~ 100.0%	100.0%
b5-17	AI1 input filter time	0.00s~10.00s	0.10s

These parameters are used to define the relationship between the analog input voltage and the corresponding setting value.

When the analog input is current input, 1 mA current corresponds to 0.5 Volts.

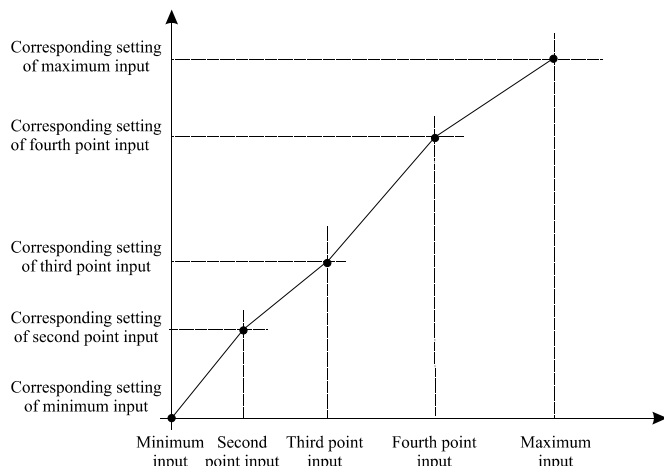

Diagram 5-21 Corresponding relationship between analog input and setting values

b5-17 (AI1 filter time) is used to set the software filter time of AI1. If the analog input is liable to interference, increase the value of this parameter to stabilize the detected analog input. However, increase of the AI filter time will slow down the response of analog detection. Set this parameter properly based on actual conditions.

In different applications, 100% of analog input corresponds to different nominal values. For details, refer to the description of different applications.

For the setting method of AI curve 2 and AI cure 3, please refer to AI curve 1.

Code	Parameter Name	Setting Range	Default
b5-18	Jump point of AI1 input corresponding setting	-100.0% ~ 100.0%	0.0%
b5-19	Jump amplitude of AI1 input corresponding setting	0.0%~100.0%	0.5%
b5-20	AI2 minimum input	0.00 V ~ 10.00 V	0.00 V
b5-21	Corresponding setting of AI2 minimum input	-100.00% ~ 100.0%	0.0%
b5-22	Second point input value of AI2	0.00 V ~ 10.00 V	2.50V

Code	Parameter Name	Setting Range	Default
b5-23	Corresponding setting of second point input value of AI2	-100.00% ~ 100.0%	25.0%
b5-24	Third point input value of AI2	0.00 V ~ 10.00 V	5.00V
b5-25	Corresponding setting of third point input value of AI2	-100.00% ~ 100.0%	50.0%
b5-26	Fourth point input value of AI2	0.00 V ~ 10.00 V	7.50V
b5-27	Corresponding setting of fourth point input value of AI2	-100.00% ~ 100.0%	75.0%
b5-28	AI2 maximum input	0.00V~ 10.00 V	10.00 V
b5-29	Corresponding setting of AI2 maximum input	-100.00%~100.0%	100.0%
b5-30	AI2 input filter time	0.00s~10.00s	0.10s
b5-31	Jump point of AI2 input corresponding setting	-100.0%~100.0%	0.0%
b5-32	Jump amplitude of AI2 input corresponding setting	0.0% ~ 100.0%	0.5%
b5-33	AI3 minimum input	0.00 V~10.00 V	0.00 V
b5-34	Corresponding setting of AI3 minimum input	-100.00%~100.0%	0.0%
b5-35	Second point input value of AI3	0.00 V ~ 10.00 V	2.50V
b5-36	Corresponding setting of second point input value of AI3	-100.00% ~ 100.0%	25.0%
b5-37	Third point input value of AI3	0.00 V ~ 10.00 V	5.00V
b5-38	Corresponding setting of third point input value of AI3	-100.00% ~ 100.0%	50.0%
b5-39	Fourth point input value of AI3	0.00 V ~ 10.00 V	7.50V
b5-40	Corresponding setting of fourth point	-100.00% ~ 100.0%	75.0%
b5-41	AI3 maximum input	0.00 V ~ 10.00 V	10.00 V
b5-42	Corresponding setting of AI3 maximum input	-100.00% ~ 100.0%	100.0%
b5-43	AI3 filter time	0.00~10.00s	0.10s
b5-44	Jump point of AI3 input corresponding setting	-100.00% ~ 100.0%	0.0%
b5-45	Jump amplitude of AI3 input corresponding setting	0.0% ~ 100.0%	0.5%

The AI terminals (AI1 to AI3) of EM11 all support the corresponding setting jump function, which fixes the AI input corresponding setting at the jump point when AI input corresponding setting jumps around the jump range.

For example:

AI1 input voltage fluctuation around 5.00V and the amplitude range is 4.90V~5.10V. AI1 minimum input

0.00V corresponds to 0.00% and maximum input 10.00V corresponds to 100.0%. The detected AI1 input corresponding setting varies between 49.0% and 51.0%.

If you set jump point b5-18 to 50.0% and jump amplitude b5-19 to 1.0%, then frequency inverter obtained AI1 input corresponding setting is fixed to 50.0%, eliminating the fluctuation effect.

5.7 Group b6: Pulse/analog output terminals

Code	Parameter Name	Default
b6-00	FMP function selection	0
b6-01	AO1 output function selection	0
b6-02	AO2 output function selection	1

The output pulse frequency of the FMP terminal ranges from 0.01 kHz to "Maximum FMP output frequency" (b6-03). The value of b6-03 is between 0.01 kHz and 100.00 kHz.

The output range of AO1 and AO2 is 0V~10 V or 0mA~20mA. The relationship between pulse and analog output ranges and corresponding functions is listed in the following table.

Value	Function	Range (Corresponding to Pulse or Analog Output Range 0.0%~100.0%)
0	Running frequency	0Hz~ maximum frequency
1	Setting frequency	0Hz~ maximum frequency
2	Output current	0 ~2 times of rated motor current
3	Output torque (absolute value)	0~ 2 times of rated motor torque(absolute value of torque)
4	Output power	0 ~2 times of rated power
5	Output voltage	0 ~1.2 times of rated frequency inverter DC bus voltage
6	Motor rotational speed	0~rotational speed corresponding to maximum frequency
7	Output current	0.0A~1000.0 A
8	Output voltage	0.0V~000.0 V
9	Output torque (actual value)	-200% of rated motor torque~ 200% of rated motor torque
10	Pulse input	0.01 kHz ~100.00 kHz
11	AI1	0V~10 V
12	AI2	0V~10 V
13	AI3	0V~10 V
14	Length	0~ maximum set length
15	Count value	0 ~ maximum count value
16	Communication setting	0~32767

Code	Parameter Name	Setting Range	Default
b6-03	Maximum FMP output frequency	0.01 kHz ~50.00 kHz	50.00 kHz

If the FM terminal is used for pulse output, this parameter is used to set the maximum frequency of pulse output.

Code	Parameter Name	Setting Range	Default
b6-04	AO1 offset coefficient	-100.0% ~100.0%	0.0%

Code	Parameter Name	Setting Range	Default
b6-05	AO1 gain	-10.00~10.00	1.00
b6-06	AO2 offset coefficient	-100.0% ~100.0%	0.00%
b6-07	AO2 gain	-10.00 ~10.00	1.00

These parameters are used to correct the zero drift of analog output and the output amplitude deviation. They can also be used to define the desired AO curve. If "b" represents zero offset, "k" represents gain, "Y" represents actual output, and "X" represents standard output, the actual output is: $Y = kX + b$.

The zero offset coefficient 100% of AO1 and AO2 corresponds to 10 V (or 20 mA). The standard output refers to the value corresponding to the analog output of 0 to 10 V (or 0 to 20 mA) with no zero offset or gain adjustment.

For example, if the analog output is used as the running frequency, and it is expected that the output is 8 V when the frequency is 0 and 3 V at the maximum frequency, the gain shall be set to -0.50, and the zero offset shall be set to 80%.

5.8 Group b7: Virtual digital input (VDI)/digital output (VDO) terminals

Code	Parameter Name	Setting Range	Default
b7-00	VDI1 function selection	0~49	0
b7-01	VDI2 function selection	0~49	0
b7-02	VDI3 function selection	0~49	0
b7-03	VDI4 function selection	0~49	0
b7-04	VDI5 function selection	0~49	0

VDI1~VDI5 have the same functions as DI terminals on the control board and can be used for digital input.

For more details, see description of b3-00 ~ b3-11.

Code	Parameter Name	Setting Range	Default
b7-05	VDI state setting mode	Unit's digit: VDI1. 0: Valid decided by state of VDOx 1: Valid decided by b7-06 Ten's digit: VDI2. 0, 1 (same as VDI1) Hundred's digit: VDI3. 0, 1 (same as VDI1) Thousand's digit: VDI4. 0, 1 (same as VDI1) Ten thousand's digit: VDI5. 0, 1 (same as VDI1)	00000
b7-06	VDI state setting	Unit's digit: VDI1. 0: Invalid 1: Valid Ten's digit: VDI2 0, 1 (same as VDI1) Hundred's digit: VDI3 0, 1 (same as VDI1) Thousand's digit: VDI4 0, 1 (same as VDI1) Ten thousand's digit: VDI5. 0, 1 (same as VDI1)	00000

Different from DI terminals, VDI state can be set in two modes, selected in b7-05:

- For example 1: Decided by state of VDOx

Whether the state of VDI is valid or not, that is determined by the state of the corresponding VDO. VDI x is uniquely bound to VDO x (x is one of 1~5). For example, to implement the function that the frequency inverter reports an alarm and stops when the AI1 input exceeds the limit, perform the following setting:

1. Set VDI1 with function 44 "User-defined fault 1" (b7-00 = 44).
2. VDI1 terminal valid is decided by state of VDO1 (b7-05= xxx0).
3. Set VDO1 with function "AI1 input limit exceeded" (b7-11 = 31).

When the AI1 input exceeds the limit, VDO1 becomes ON. At this moment, VDI1 becomes ON and the frequency inverter receives you-defined fault 1. Then the frequency inverter reports Err27 and stops.

- Example 2: Decided by b7-06

The VDI state is determined by b7-06. For example, to implement the function that the frequency inverter automatically enters the running state after power-on, perform the following setting:

1. Set VDI1 with function 1 "Forward RUN (FWD)" (b7-00 = 1).
2. Set b7-05 to xxx1: The state of VDI1 is decided by b7-06.
3. Set b7-06 to xxx1: VDI1 is valid.
4. Set b0-02 to 1: The command source to terminal control.
5. Set b2-32 to 0: Startup protection is not enabled.

When the frequency inverter completes initialization after power-on, it detects that VDI1 is valid and VDI1 is set with the function of forward RUN. That is, the frequency inverter receives the forward RUN command from the terminal. Therefore, the frequency inverter starts to run in forward direction.

Code	Parameter Name	Setting Range	Default
b7-07	Function selection for AI1 used as DI	0~49	0
b7-08	Function selection for AI2 used as DI	0~49	0
b7-09	Function selection for AI3 used as DI	0~49	0
b7-10	Valid state selection for AI used as DI	Unit's digit: AI1. 0: High level valid 1: Low level valid Ten's digit: AI2. 0, 1 (same as unit's digit) Hundred's digit: AI3. 0, 1 (same as unit's digit)	0

The functions of these parameters are to use AI as DI. When AI is used as DI, the AI state is high level if the AI input voltage is 7 V or higher and is low level if the AI input voltage is 3 V or lower.

If the AI input voltage is between 3 V and 7 V, the AI state is hysteresis. And then b7-10 is used to determine whether high level valid or low level valid when AI is used as DI.

The setting of AI (used as DI) function is the same as that of DI. For details, see the descriptions of DI setting.

The following figure takes AI input voltage as an example to describe the relationship between AI input voltage and corresponding DI state.

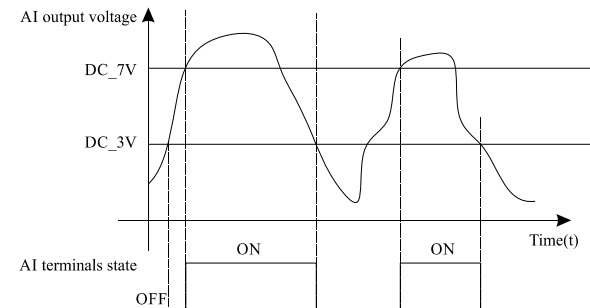

Diagram 6-22 Relationship of AI input voltage and corresponding DI status

Code	Parameter Name	Setting Range	Default
b7-11	VDO1 function selection	0: connect with physical DIx internally 1~38	38
b7-12	VDO2 function selection	0: connect with physical DIx internally 1~38	38
b7-13	VDO3 function selection	0: connect with physical DIx internally 1~38	38
b7-14	VDO4 function selection	0: connect with physical DIx internally 1~38	38
b7-15	VDO5 function selection	0: connect with physical DIx internally 1~38	38
b7-16	VDO1 output delay	0.0s~3000.0s	0.0s
b7-17	VDO2 output delay	0.0s~3000.0s	0.0s
b7-18	VDO3 output delay	0.0s~3000.0s	0.0s
b7-19	VDO4 output delay	0.0s~3000.0s	0.0s
b7-20	VDO5 output delay	0.0s~3000.0s	0.0s
b7-21	VDO valid state selection	Unit's digit: VDO1. 0: Positive logic valid 1: Reverse logic valid Ten's digit: VDO2 0, 1 (same as unit's digit) Hundred's digit: VDO3. 0, 1 (same as unit's digit) Thousand's digit: VDO4. 0, 1 (same as unit's digit) Ten thousand's digit: VDO5. 0, 1 (same as unit's digit)	00000

VDO functions are similar to the DO functions on the control board. The VDO can be used together with VDI x to implement some simple logic control.

- If VDO function is set to 0, the state of VDO1 to VDO5 is determined by the state of DI1 to DI5 on the control board. In this case, VDOx and DIx are one-to-one mapping relationship.
- If VDO function is set to non-0, the function setting and use of VDOx are the same as DO in group b4.

The VDOx state valid can be set in b7-21. The application examples of VDIx involved the usage of VDOx, and please see these examples for your reference.

5.9 Group b8: AI/AO Correction

Code	Parameter Name	Setting Range	Default
b8-00	Ideal voltage of AI1 calibration 1	0.500~4.000 V	2.000V
b8-01	Sampling voltage of AI1 calibration 1	0.500~4.000 V	2.000V
b8-02	Ideal voltage of AI1 calibration 2	6.000~9.999 V	8.000V
b8-03	Sampling voltage of AI1 calibration 2	6.000~9.999 V	8.000V
b8-04	Ideal voltage of AI2 calibration 1	0.500~4.000 V	2.000V
b8-05	Sampling voltage of AI2 calibration 1	0.500~4.000 V	2.000V
b8-06	Ideal voltage of AI2 calibration 2	6.000~9.999 V	8.000V
b8-07	Sampling voltage of AI2 calibration 2	6.000~9.999 V	8.000V
b8-08	Ideal voltage of AI3 calibration 1	0.500~4.000 V	2.000V
b8-09	Sampling voltage of AI3 calibration 1	0.500~4.000 V	2.000V
b8-10	Ideal voltage of AI3 calibration 2	6.000~9.999 V	8.000V
b8-11	Sampling voltage of AI3 calibration 2	6.000~9.999 V	8.000V

These parameters are used to correct the AI to eliminate the impact of AI zero offset and gain.

They have been corrected of delivery. When you resume the factory values, these parameters will be restored to the factory-corrected values. Generally, you need not perform correction in the applications.

Measured voltage indicates the actual output voltage value measured by instruments such as the multimeter. Displayed voltage indicates the voltage display value sampled by the frequency inverter. For details, refer to the voltage displayed before AI correction in group U0.

During correction, send two voltage values to each AI terminal, and save the measured values and displayed values to the function codes b8-00 to b8-11. Then the frequency inverter will automatically perform AI zero offset and gain correction.

If the input voltage and the actual voltage sampled by the HC drive are inconsistent, perform correction on site. Take AI1 as an example. The on-site correction is as follows:

1. Send a voltage signal (approximately 2 V) to AI1.
2. Measure the AI1 voltage and save it to b8-00.
3. View the displayed value of U0-21 and save the value to b8-01.
4. Send a voltage signal (approximately 8 V) to AI1.
5. Measure AI1 voltage and save it to b8-02.
6. View the displayed value of U0-21 and save the value to b8-03.

At correction of AI2 and AI3, the actually sampled voltage is respectively queried in U0-22 and U0-23.

For AI1 and AI2, 2 V and 8 V are suggested as the correction voltages. For AI3, -8 V and 8V are suggested.

Code	Parameter Name	Setting Range	Default
b8-12	Ideal voltage of AO1 calibration 1	0.500~4.000 V	2.000V
b8-13	Measured voltage of AO1 calibration 1	0.500~4.000 V	2.000V
b8-14	Ideal voltage of AO1 calibration 2	6.000~9.999 V	8.000V
b8-15	Measured voltage of AO1 calibration 2	6.000~9.999 V	8.000V
b8-16	Ideal voltage of AO2 calibration 1	0.500~4.000 V	2.000V
b8-17	Measured voltage of AO2 calibration 1	0.500~4.000 V	2.000V
b8-18	Ideal voltage of AO2 calibration 2	6.000~9.999 V	8.000V
b8-19	Measured voltage of AO2 calibration 2	6.000~9.999 V	8.000V

These parameters are used to correct the AO.

They have been corrected of delivery. When you store the factory default values, these parameters will be restored to the factory-corrected values. Generally you needn't perform correction in the applications.

Ideal target voltage indicates the theoretical output voltage of the frequency inverter. Measured voltage indicates the actual output voltage value measured by instruments such as the multimeter.

5.10 Group b9: Operation Panel and Display

Code	Parameter Name	Setting Range	Default
b9-00	STOP/RESET key function	0: STOP/RESET key enabled only in operation panel control 1: STOP/RESET key enabled in any operation mode	0
b9-01	MF.K Key function selection	0: MF.K key disabled 1: Switchover between operation panel control and remote command control (terminal or communication) 2: Switchover between forward rotation and reverse rotation 3: Forward JOG 4: Reverse JOG	0

MF.K key refers to multifunctional key. You can set the function of the MF.K key by using this parameter. You can perform switchover by using this key both in stop or running state.

0: MF.K key disabled

This key is disabled.

1: Switchover between operation panel control and remote command control (terminal or communication)

You can perform switchover from the present command source to the operation panel control (local operation). If the present command source is operation panel control, this key is invalid.

2: Switchover between forward rotation and reverse rotation

You can change the direction of the frequency inverter running by using the MF.K key. It is valid only when the present command source is operation panel control.

3: Forward JOG

You can perform forward JOG (FJOG) by using the MF.K key.

4: Reverse JOG

You can perform reverse JOG (FJOG) by using the MF.K key.

Code	Parameter Name	Setting Range	Default
b9-02	LED display running parameters 1	0000~FFFF: <p>If a parameter needs to be displayed during the running, set the corresponding bit to 1, and set b9-02 to the hexadecimal equivalent of this binary number.</p>	0x1f
b9-03	LED display running parameters 2	0000~FFFF: <p>If a parameter needs to be displayed during the running, set the corresponding bit to 1, and set b9-03 to the hexadecimal equivalent of this binary number.</p>	0x0800

Code	Parameter Name	Setting Range	Default
b9-03	LED display running parameters 2		0x0800

These two parameters are used to set the monitoring parameters that can be viewed when the frequency inverter is in the running state. You can view a maximum of 32 running state. The displaying sequence is displayed from the lowest bit of b9-02.

Code	Parameter Name	Setting Range	Default
b9-04	LED display parameter of stopping	0000~FFFF: <p>If a parameter needs to be displayed during the running, set the corresponding bit to 1, and set b9-04 to the hexadecimal equivalent of this binary number.</p>	0x2033

Code	Parameter Name	Setting Range	Default
b9-05	Load speed display coefficient	0.0001~ 6.5000	1.0000

This parameter is used to adjust the relationship between the output frequency of frequency inverter and the load speed. For details, see the description of b9-06.

Code	Parameter Name	Setting Range	Default
------	----------------	---------------	---------

Code	Parameter Name	Setting Range	Default
b9-06	Number of decimal places for load speed display	0: 0 decimal display 1: 1 decimal display 2: 2 decimal display 3: 3 decimal display	1

b9-06 is used to set the number of decimal places for load speed display. The following gives an example to explain how to calculate the load speed:

Assume that b9-05 (Load speed display coefficient) is 2.000 and b9-06 is 2 (2 decimal places). When the running frequency of the frequency inverter is 40.00 Hz, the load speed is $40.00 \times 2.000 = 80.00$ (display of 2 decimal places).

If the frequency inverter is in the stop state, the load speed is the speed corresponding to the set frequency, namely, "setting load speed". If the set frequency is 50.00 Hz, the load speed in the stop state is $50.00 \times 2.000 = 100.00$ (display of 2 decimal places).

Code	Parameter Name	Setting Range	Default
b9-07	Heatsink temperature	0.0°C ~100.0°C	0°C

It is used to display the temperature of heatsink.

Different inverter model has different temperature value for over-temperature protection.

Code	Parameter Name	Setting Range	Default
b9-08	Accumulative power-on time	0~65535 h	0 h

It is used to display the accumulative power-on time of the frequency inverter since the delivery. If the time reaches the set power-on time (b2-21), the terminal with the digital output function 24 becomes ON.

Code	Parameter Name	Setting Range	Default
b9-09	Accumulative running time	0~65535 h	0 h

It is used to display the accumulative running time of the frequency inverter. After the accumulative running time reaches the value set in b2-21, the terminal with the digital output function 12 becomes ON.

Code	Parameter Name	Setting Range	Default
b9-10	Accumulative power consumption	0~65535 kWh	0 kWh

It is used to display the accumulative power consumption of the frequency inverter until now.

5.11 Group bA: Communication parameters

Code	Parameter Name	Setting Range	Default
bA-00	Communication type selection	0: Modbus protocol	0

The EM11 now supports Modbus, later will add the communication protocol such as PROFIBUS-DP and CANopen. For details, see the description of "EM11 communication protocol".

Code	Parameter Name	Setting Range	Default
bA-01	Baud ratio setting	Unit's digit: Modbus baud ratio. 0: 300 BPS 1: 600 BPS 2: 1200 BPS 3: 2400 BPS 4: 4800 BPS 5: 9600 BPS 6: 19200 BPS 7: 38400 BPS	5

This parameter is used to set the data transfer baud rate from host computer to frequency inverter. Please note that baud rate of the host computer and the inverter should be consistent. Otherwise, the communication is impossible. The higher the baud rate is, the faster the communication is.

Code	Parameter Name	Setting Range	Default
bA-02	Modbus Data format	0: No check, data format <8,N,2> 1: Even parity check, data format<8,E,1> 2: Odd Parity check, data format<8,O,1> 3: No check, data format <8,N,1> Valid for Modbus	0

The host computer and inverter setup data format must be consistent, otherwise, communication is impossible.

Code	Parameter Name	Setting Range	Default
bA-03	Broadcast address	1~249 (0: Broadcast address) Valid for Modbus	0

When the local address is set to 0, that is, broadcast address, it can realize the broadcast function of host computer.

The address is unique; it is base of point to point communication between host computer and frequency inverter.

Code	Parameter Name	Setting Range	Default
bA-04	Modbus response delay	0~20 ms (Only valid for Modbus)	2 ms

Response delay: it refers to the interval time from the inverter finishes receiving data to response data back to the host machine. If the response delay is less than the system processing time, then the response time is based on the time of the system processing. If the response delaying time is more than the system processing time, after the system processes the data, it should be delayed to wait until the response delay time is reached, and then sending back data to host machine.

Code	Parameter Name	Setting Range	Default
bA-05	Communication timeout	0.0s:invalid 0.1s~60.0s Valid for Modbus	0.0s

When this parameter is set to 0.0s, the communication interface timeout function is invalid.

When the function code is set to a value, if the interval time between this communication and the next communication is beyond the communication timeout, the system will report communication failure error

(Err16). At normal application, it will be set as invalid. If in the continuous communication system, setting this parameter, you can monitor the communication status.

Code	Parameter Name	Setting Range	Default
ba-06	Modbus protocol data transmission format selection	Unit's digit: Modbus protocol. 0: Non-standard Modbus protocol 1: Standard Modbus protocol	1

ba-06=1: Select standard Modbus protocol.

ba-06=0: When reading the command, the slave machine return is one byte more than the standard Modbus protocol's, for details, refer to communication data structure of appendix .

Code	Parameter Name	Setting Range	Default
ba-07	Communication reading current resolution	0: 0.01A 1: 0.1A	0

It is used to confirm the unit of current value when the communication reads the output current.

5.12 Group bb: Fault and Protection

Code	Parameter Name	Setting Range	Default
bb-00	G/P type selection	0: P type 1: G type	1

This parameter is used to display the delivered model and cannot be modified.

0: Applicable to variable torque load (fan and pump) with rated parameters specified.

1: Applicable to constant torque general load with rated parameters specified.

Code	Parameter Name	Setting Range	Default
bb-01	Motor overload protection selection	0: Disabled 1: Enabled	0
bb-02	Motor overload protection gain	0.20~10.00	1.00

● bb-01 = 0

The motor overload protective function is disabled. The motor is exposed to potential damage due to overheating. A thermal relay is suggested to be installed between the frequency inverter and the motor.

● bb-01 = 1

The frequency inverter judges whether the motor is overloaded according to the inverse time-lag curve of the motor overload protection.

The inverse time-lag curve of the motor overload protection is:

$$220\% \times (\text{bb-02}) \times \text{rated motor current}$$

(if the load remains at this value for one minute, the frequency inverter reports motor overload fault), or

$$150\% \times (\text{bb-02}) \times \text{rated motor current}$$

(if the load remains at this value for 60 minutes, the frequency inverter reports motor overload fault).

Set bb-02 properly based on the actual overload capacity. If the value of bb-02 is set too large, may result in damaging to the motor because the motor overheats but the frequency inverter does not report the alarm.

Code	Parameter Name	Setting Range	Default
bb-03	Motor overload pre-warning coefficient	50%~100%	80%

This function is used to give a warning signal to the control system via DO before motor overload protection. This parameter is used to determine the percentage, at which pre-warning is performed before motor overload. The larger the value is, the less advance the pre-warning will be.

When the output current of the frequency inverter is greater than the value of the overload inverse time-lag curve multiplied by bb-03, the DO terminal of the frequency inverter set with motor overload pre-warning becomes ON.

Code	Parameter Name	Setting Range	Default
bb-04	Overvoltage stall gain	0~100	0
bb-05	Overvoltage stall protective voltage	120%~150%	130%

When the DC bus voltage exceeds the value of bb-05 (Overvoltage stall protective voltage) during deceleration of the frequency inverter, the frequency inverter stops deceleration and keeps the present running frequency. After the bus voltage declines, the frequency inverter continues to decelerate.

bb-04 (Overvoltage stall gain) is used to adjust the overvoltage suppression capacity of the frequency inverter. The larger the value is, the greater the overvoltage suppression capacity will be. In the prerequisite of no overvoltage occurrence, set bb-04 to a small value.

For small-inertia load, the value should be small. Otherwise, the system dynamic response will be slow. For large-inertia load, the value should be large. Otherwise, the suppression result will be poor and an overvoltage fault may occur.

If the overvoltage stall gain is set to 0, the overvoltage stall function is disabled. The overvoltage stall protective voltage setting 100% corresponds to the base values in the following table:

Voltage Class	Corresponding Base Value
Single-phase 220 V	290 V
Three-phase 220 V	290 V
Three-phase 380 V	530 V
Three-phase 480 V	620 V
Three-phase 690 V	880 V

Code	Parameter Name	Setting Range	Default
bb-06	Over current stall gain	0~100	20
bb-07	Over current stall protective current	100%~200%	150%

Over current stall: When the output current exceeds the over current stall protective current (bb-07) during acceleration/deceleration of the frequency inverter, the frequency inverter stops acceleration/deceleration and keeps the present running frequency. After the output current declines to below bb-07, the frequency inverter continues to accelerate/decelerate.

bb-07 (over current stall protective current) is used to select the current protection value of over current stall

function. This function will be carried out by frequency inverter, when the current exceeds bb-07. This value is the percentage of motor rated current.

bb-06 (over current stall gain) is used to adjust the over current suppression capacity of the frequency inverter. The larger the value is, the greater the over current suppression capacity will be. In condition of no over current occurrence, should set bb-06 to a small value.

For small-inertia load, the value should be small. Otherwise, the system dynamic response will be slow. For large-inertia load, the value should be large. Otherwise, the suppression result will be poor and over current fault may occur. If the over current stall gain is set to 0, the over current stall function is disabled.

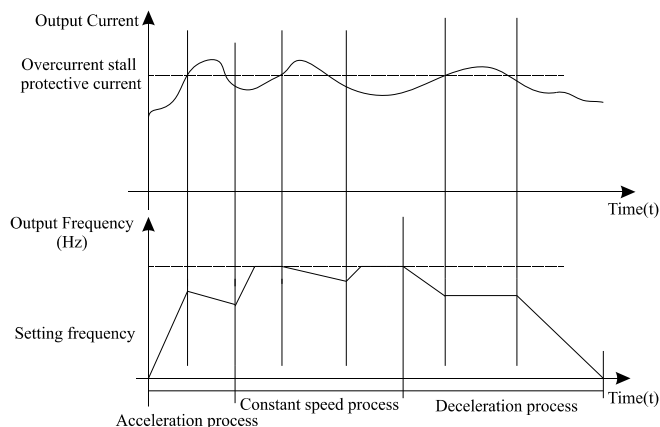

Diagram 5-23 Diagram of the over current stall protection function

Code	Parameter Name	Setting Range	Default
bb-08	Protection of short-circuit to ground after power-on	0: Disabled 1: Enabled	1

It is used to determine whether to check the motor is short-circuited to ground after power-on of the frequency inverter. If this function is enabled, the frequency inverter's UVW will have voltage output a while after power-on.

Code	Parameter Name	Setting Range	Default
bb-09	Fault auto reset times	0~99	0

It is used to set the times of fault auto resets if this function is used. After the value is exceeded, the frequency inverter will remain in the fault state.

Code	Parameter Name	Setting Range	Default
bb-10	Relay action selection during fault auto reset	0: Not act 1: Act	0

It is used to decide whether DO acts during the fault auto reset if the fault auto reset function is used.

Code	Parameter Name	Setting Range	Default
bb-11	Time interval of fault auto reset	0.1s~100.0s	1.0s

It is used to set the waiting time from the frequency inverter alarm to fault auto reset.

Code	Parameter Name	Setting Range	Default
bb-12	Input phase loss protection/contactor energizing protection selection	Unit's digit: Input phase loss protection 0: Disabled 1: Enabled Ten's digit: Contactor energizing protection 0,1(same as Unit's digit)	0

It is used to determine whether to perform input phase loss or contactor energizing protection.

The EM11 models that provide this function are listed in the following table.

Voltage Class	Models
Single-phase 220 V	None
Three-phase 220 V	From 11 kW G model
Three-phase 380 V	From 18.5 kW G model
Three-phase 690 V	From 18.5 kW G model

For every voltage class, the EM11 frequency inverters provide function of input phase loss or contactor energizing protection for above model. The EM11 Frequency inverters do not have this function below the power listed in the table no matter whether bb-12 is set to 0 or 1.

Code	Parameter Name	Setting Range	Default
bb-13	Output phase loss protection	0: Disabled 1: Enabled	0

It is used to determine whether to perform output phase loss protection.

Code	Parameter Name	Setting Range	Default
bb-14	Off load protection	0: Disabled 1: Enabled	0
bb-15	Off load detection level	0.0%~100.0% (rated motor current)	1.0%
bb-16	Off load detection time	0.0s~60.0s	1.0s

If off load protection is enabled, when the output current of the frequency inverter is lower than the detection level (bb-15) and the duration time exceeds the detection time (bb-16), the output frequency of frequency inverter automatically declines to 7% of the rated frequency. During the protection, the frequency inverter automatically accelerates to the set frequency if the load restore to normal.

Code	Parameter Name	Setting Range	Default
bb-17	Over-speed detection value	0.0%~50.0% (maximum frequency)	20.0%
bb-18	Over-speed detection time	0.0s~60.0s	1.0s

This function is valid only when the frequency inverter runs in the VC+PG mode.

If the actual motor rotational speed detected by the frequency inverter exceeded the maximum frequency and the excessive value is greater than the value of bb-17 and the lasting time exceeded the value of bb-18, the frequency inverter reports Err43 and acts according to the selected fault protection action.

If the bb-18(over-speed detection time) is 0.0s, the over-speed detection function is disabled.

Code	Parameter Name	Setting Range	Default
bb-19	Detection value of too large speed deviation	0.0%~50.0% (maximum frequency)	20.0%
bb-20	Detection time of too large speed deviation	0.0s~60.0s	5.0s

This function is valid only when the frequency inverter runs in the VC+PG mode.

If the frequency inverter detects the deviation over than bb-19 between the actual motor rotational and the setting motor frequency, and the duration time exceeds the value of bb-20, the frequency inverter reports Err42 and act according to the selected fault protection action.

If bb-20 (Detection time of too large speed deviation) is 0.0s, this function is disabled.

Code	Parameter Name	Setting Range	Default
bb-21	Action selection at instantaneous power failure	0: Invalid 1: Decelerate 2: Decelerate to stop	0
bb-22	Voltage rally judging time at instantaneous power failure	0.00s ~100.00s	0.00s
bb-23	Judging voltage of instantaneous power failure	60.0%~100.0% (standard bus voltage)	80.0%
bb-24	Judging voltage of instantaneous power failure restoring	60.0%~100.0% (standard bus voltage)	90.0%

Of instantaneous power failure or sudden voltage dip, the DC bus voltage of the Frequency inverter reduces. This function enables the Frequency inverter to compensate the DC bus voltage reduction with the load feedback energy by reducing the output frequency so as to keep the Frequency inverter running continuously.

- If bb-21 = 1, when instantaneous power failure or sudden voltage dip, the frequency inverter decelerates until DC bus voltage restore to normal, the frequency inverter accelerates to the set frequency. If the DC bus voltage remains normal for the time exceeding the value set in bb-22, it is considered that the DC bus voltage restores to normal.
- If bb-21 = 2, when instantaneous power failure or sudden voltage dip, the frequency inverter decelerates to stop.

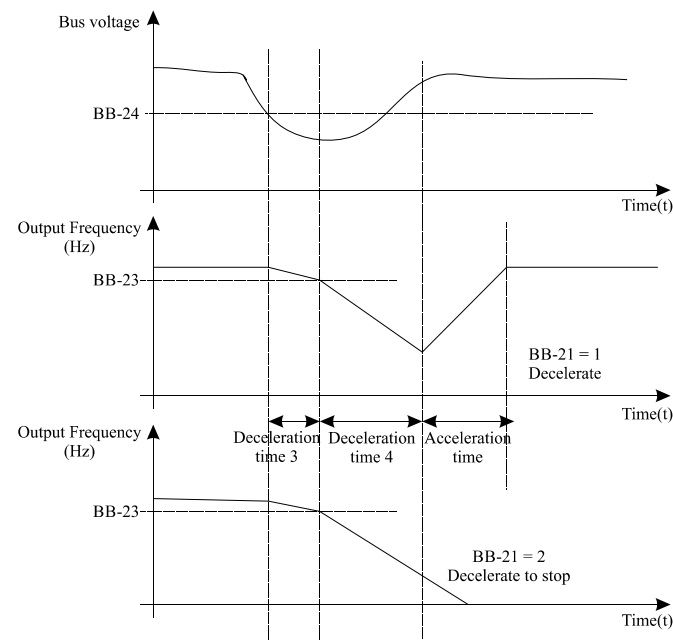

Diagram 5-24 Frequency inverter action diagram of instantaneous power failure

Code	Parameter Name	Setting Range	Default
bb-25	Type of motor temperature sensor	0: No temperature sensor 1: PT100 2: PT1000	0
bb-26	Motor overheat protection threshold	0°C~200°C	120°C
bb-27	Motor overheat pre-warning threshold	0°C~200°C	100°C

The signal of the motor temperature sensor needs to be connected to the optional I/O extension card. This card is an optional component. PG card also can be used for the temperature signal input with motor over-temperature protection function. Please contact with manufacturer or distributors.

The PG card interface of the EM11 supports both PT100 and PT1000. Set the sensor type correctly during the use. You can view the motor temperature via parameter U0-34.

If the motor temperature exceeds the value set in bb-26, the frequency inverter reports an alarm and acts according to the selected fault protection action.

If the motor temperature exceeds the value set in bb-27, the DO terminal of frequency inverter set with motor overheat warning becomes ON.

Code	Parameter Name	Setting Range	Default
bb-28	Overvoltage threshold	200.0~2500.0 V	830.0 V

It is used to set the overvoltage threshold of the frequency inverter. The default values of different voltage classes are listed in the following table.

Voltage Class	Default Overvoltage Threshold
Single-phase 220 V	400.0 V
Three-phase 220 V	400.0 V
Three-phase 380 V	830.0 V
Three-phase 480 V	890.0 V
Three-phase 690 V	1300.0 V

Note: The default value is also the upper limit of the frequency inverter's internal overvoltage protection voltage. The parameter becomes effective only when the setting of bb-28 is lower than the default value. If the setting is higher than the default value, use the default value.

Code	Parameter Name	Setting Range	Default
bb-29	Under voltage threshold	50.0%~150.0%	100.0%

It is used to set the under voltage threshold of Err09. The under voltage threshold 100% of the frequency inverter of different voltage classes corresponds to different nominal values, as listed in the following table.

Voltage Class	Nominal Value of under voltage threshold
Single-phase 220 V	200 V
Three-phase 220 V	200 V
Three-phase 380 V	350 V
Three-phase 480 V	450 V
Three-phase 690 V	650 V
Three-phase 1140V	1350V

Code	Parameter Name	Setting Range	Default
bb-30	Brake unit use ratio	0%~100%	100%

It is valid only for the frequency inverter with internal braking unit and used to adjust the duty ratio of the braking unit. The larger the value of this parameter is, the better the braking result will be. However, too larger value causes great fluctuation of DC bus voltage during the braking process.

Code	Parameter Name	Setting Range	Default
bb-31	Rapid current limit	0: Disabled 1: Enabled	1

The rapid current limit function can reduce the frequency inverter over current faults at maximum, guaranteeing uninterrupted running of the frequency inverter.

However, long-time rapid current limit may cause the frequency inverter to overheat, which is not allowed. In this case, the frequency inverter will report Err40, indicating the frequency inverter is overloaded and needs to stop.

Code	Parameter Name	Setting Range	Default
bb-32	Fault protection action selection 1	Unit's digit: Motor overload, Err11. 0: Free stop 1: Stop according to the stop mode 2: Continue to run Ten's digit: Power input phase loss, Err12. Same as unit's digit Hundred's digit: Power output phase loss, Err13. Same as unit's digit Thousand's digit: External equipment fault, Err15. Same as unit's digit Ten thousand's digit: Communication fault, Err16. Same as unit's digit	00000
bb-33	Fault protection action selection 2	Unit's digit: Encoder/PG card fault, Err20. 0: Free stop Ten's digit: EEPROM read-write fault, Err21. 0: Free stop 1: Stop according to the stop mode Hundred's digit: Reserved Thousand's digit: Motor Overheat, Err25. Same as unit's digit in bb-32 Ten thousand's digit: Running time reached, Err26. Same as unit's digit in bb-32	00000
bb-34	Fault protection action selection 3	Unit's digit: User-defined fault 1,Err27. Same as unit's digit in bb-32 Ten's digit: User-defined fault 2,Err28. Same as unit's digit in bb-32 Hundred's digit: Accumulative power-on time reached,Err29. Same as unit's digit in bb-32 Thousand's digit: Off load, Err30. 0: Free stop 1: Stop according to the stop mode 2: reduce to 7% of rated motor frequency and continue running. If the load recovers and it will auto regain to setting frequency. Ten thousand's digit: PID feedback lost during running, Err31. Same as unit's digit in bb-32	00000
bb-35	Fault protection action selection 4	Unit's digit: Speed deviation too large, Err42 Same as unit's digit in bb-32 Ten's digit: Motor over-speed, Err43. Same as unit's digit in bb-32 Hundred's digit: Initial position fault, Err51. Same as unit's digit in bb-32	00000

- If "free stop" is selected, the frequency inverter displays Err** and directly stops.
- If "Stop according to the stop mode" is selected, the frequency inverter displays A** and stops according to the stop mode. After stop, the frequency inverter displays Err**.
- If "Continue to run" is selected, the frequency inverter continues to run and displays A**. The running

frequency is set in bb-36.

Code	Parameter Name	Setting Range	Default
bb-36	Frequency selection for continuing to run of fault	0: Current running frequency 1: Set frequency 2: Frequency upper limit 3: Frequency lower limit 4: Backup frequency of abnormality (bb-37)	0
bb-37	Backup frequency of abnormality	0.0%~100.0% (maximum frequency)	1.0%

If a fault occurs during the running of the frequency inverter and the handling of fault is set to "continue to run", the frequency inverter displays A** and continues to run at the frequency set in bb-36.

The setting of bb-37 is a percentage relative to the maximum frequency.

5.13 Group bC: Fault detection Parameters

Code	Parameter Name	Setting Range
bC-00	1st fault type	0~99
bC-01	2nd fault type	0~99
bC-02	3rd fault type (latest)	0~99

It is used to record the types of the most recent three faults of the frequency inverter. 0 indicates no fault. For possible causes and solution of each fault, refer to Chapter 8.

Code	Parameter Name	Description										
bC-03	Frequency of latest fault	It displays the frequency when the latest fault occurs.										
bC-04	Current of latest fault	It displays the current when the latest fault occurs.										
bC-05	DC Bus voltage of latest fault	It displays the DC bus voltage when the latest fault occurs.										
bC-06	Input terminals status of latest fault	It displays the status of all DI terminals when the latest fault occurs. The sequence is as follows: <table border="1" style="margin-left: 20px;"> <tr> <td>BIT9</td><td>BIT8</td><td>BIT7</td><td>BIT6</td><td>BIT5</td><td>BIT4</td><td>BIT3</td><td>BIT2</td><td>BIT1</td><td>BIT0</td> </tr> </table> DI0 DI9 DI8 DI7 DI6 DI5 DI4 DI3 DI2 DI1 If a DI is ON, the setting is 1. If the DI is OFF, the setting is 0. The value is the equivalent decimal number converted from the DI status.	BIT9	BIT8	BIT7	BIT6	BIT5	BIT4	BIT3	BIT2	BIT1	BIT0
BIT9	BIT8	BIT7	BIT6	BIT5	BIT4	BIT3	BIT2	BIT1	BIT0			
bC-07	Output terminal status of latest fault	It displays the status of all output terminals when the latest fault occurs. The sequence is as follows: <table border="1" style="margin-left: 20px;"> <tr> <td>BIT4</td><td>BIT3</td><td>BIT2</td><td>BIT1</td><td>BIT0</td> </tr> </table> DO2 DO1 REL2 REL1 FMP If an output terminal is ON, the setting is 1. If the output terminal is OFF, the setting is 0. The value is the equivalent decimal number converted from the DI statuses.	BIT4	BIT3	BIT2	BIT1	BIT0					
BIT4	BIT3	BIT2	BIT1	BIT0								
bC-08	Frequency inverter status of latest fault	Reserved										
bC-09	Power-on time of latest fault	It displays the present power-on time when the latest fault occurs.										

Code	Parameter Name	Description	
bC-10	Running time of latest fault	It displays the present running time when the latest fault occurs.	
bC-11	Frequency of 2nd fault	Same as bC-03~bC-10.	
bC-12	Current of 2nd fault		
bC-13	DC Bus voltage of 2nd fault		
bC-14	Input terminal status of 2nd fault		
bC-15	Output terminal status of 2nd fault		
bC-16	Frequency inverter status of 2nd fault		
bC-17	Power-on time of 2nd fault		
bC-18	Running time of 2nd fault		
bC-19	Frequency of 1st fault		Same as bC-03~bC-10.
bC-20	Current of 1st fault		
bC-21	DC Bus voltage of 1st fault		
bC-22	Input terminal status of 1st fault		
bC-23	Output terminal status of 1st fault		
bC-24	Frequency inverter status of 1st fault		
bC-25	Power-on time of 1st fault		
bC-26	Running time of 1st fault		

5.14 Group C0: Process Control PID Function

PID control is a general process control method. By performing proportional, integral and differential operations on the difference between the feedback signal and the target signal, it adjusts the output frequency and constitutes a feedback system to stabilize the controlled counter around the target value.

It is applied to process control such as flow control, pressure control and temperature control. The following figure shows the principle block diagram of PID control.

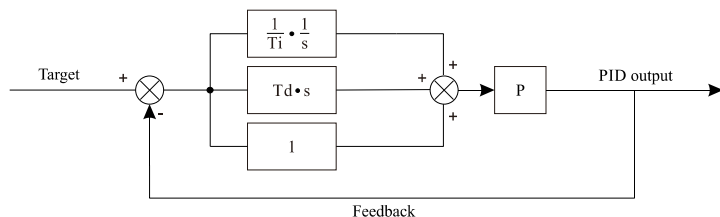

Diagram 6-25 Principle block diagram of PID control.

Code	Parameter Name	Setting Range	Default
C0-00	PID setting source	0: C0-01 1: AI1 2: AI2 3: AI3 4: Pulse setting (DI6) 5: Communication setting 6: Multi-function	0
C0-01	PID digital setting	0.0%~100.0%	50.0%

C0-00 is used to select the channel of target process PID setting. The PID setting is a relative value and ranges from 0.0% to 100.0%. The PID feedback is also a relative value. The purpose of PID control is to make the PID setting and PID feedback equal.

Code	Parameter Name	Setting Range	Default
C0-02	PID setting change time	0.00s~650.00s	0.00s

The PID setting change time indicates the time required for PID setting changing from 0.0% to 100.0%. The PID setting changes linearly according to the change time, reducing the impact caused by sudden setting change on the system.

Code	Parameter Name	Setting Range	Default
C0-03	PID feedback source	0: AI1 1: AI2 2: AI3 3: Pulse setting (HDI) 4: AI1 - AI2 5: AI1 + AI2 6: MAX (AI1 , AI2) 7: MIN (AI1 , AI2) 8: Communication setting	0

This parameter is used to select the feedback signal channel of process PID. The PID feedback is a relative value and ranges from 0.0% to 100.0%. Similarly, the feedback of PID is also a relative value. The function of PID is to make the two values the equal.

Code	Parameter Name	Setting Range	Default
C0-04	PID action direction	0: Forward action 1: Reverse action	0

0: Forward action

When the feedback value is smaller than the PID setting, the frequency inverter's output frequency rises. For example, the winding tension control requires forward PID action.

1: Reverse action

When the feedback value is smaller than the PID setting, the frequency inverter's output frequency reduces. For example, the unwinding tension control requires reverse PID action.

Note this function is influenced by the DI function 24 "Reverse PID action direction".

Code	Parameter Name	Setting Range	Default
C0-05	PID setting feedback range	0~65535	1000

This parameter is a non-dimensional unit. It is used for PID setting display (U0-15) and PID feedback display (U0-16).

Relative value 100% of PID setting feedback corresponds to the value of C0-05. If C0-05 is set to 2000 and PID setting is 100.0%, the PID setting display (U0-15) is 2000.

Code	Parameter Name	Setting Range	Default
C0-06	Proportional gain KP1	0.00~10.0	20.0
C0-07	Integral time TI1	0.01s~10.00s	2.00s
C0-08	Differential time TD1	0.000s~10.000s	0.000s

- C0-06 (Proportional gain Kp1)

It decides the regulating intensity of the PID regulator. The higher the Kp1 is, the larger the regulating intensity is. The value 10.00 indicates when the deviation between PID feedback and PID setting is 100.0%, the adjustment amplitude of the PID regulator on the output frequency reference is the maximum frequency.

- C0-07 (Integral time Ti1)

It decides the integral regulating intensity. The shorter the integral time is, the larger the regulating intensity is. When the deviation between PID feedback and PID setting is 100.0%, the integral regulator performs continuous adjustment for the time. Then the adjustment amplitude reaches the maximum frequency.

- C0-08 (Differential time Td1)

It decides the regulating intensity of the PID regulator on the deviation change. The longer the differential time is, the larger the regulating intensity is. Differential time is the time within which the feedback value change reaches 100.0%, and then the adjustment amplitude reaches the maximum frequency.

Code	Parameter Name	Setting Range	Default
C0-09	Proportional gain KP2	0.00~10.00	20.0
C0-10	Integral time TI2	0.01s~10.00s	2.00s
C0-11	Differential time TD2	0.00s~10.00s	0.000s
C0-12	PID parameter switchover condition	0: No switchover 1: Switchover via DI 2: Automatic switchover based on deviation	0
C0-13	PID parameter switchover deviation 1	0.0% ~ C0-14	20.0%

Code	Parameter Name	Setting Range	Default
C0-14	PID parameter switchover deviation 2	C0-13 ~ 100.0%	80.0%

In some applications, PID parameters switchover is required when one group of PID parameters cannot satisfy the requirement of the whole running process.

These parameters are used for switchover between two groups of PID parameters. Regulator parameters C0-09 ~ C0-11 are set in the same way as C0-06 ~ C0-08.

The switchover can be implemented either via a DI terminal or automatically implemented based on the deviation.

If you select switchover via a DI terminal, the DI must be set with function 43 "PID parameter switchover". If the DI is OFF, group 1 (C0-06 ~ C0-08) is selected. If the DI is ON, group 2 (C0-09 to C0-11) is selected.

If you select automatic switchover, when the absolute value of the deviation between PID feedback and PID setting is smaller than the value of C0-13, group 1 is selected. When the absolute value of the deviation between PID feedback and PID setting is higher than the value of C0-14, group 2 is selected. When the deviation is between C0-13 and C0-14, the PID parameters are the linear interpolated value of the two groups of parameter values.

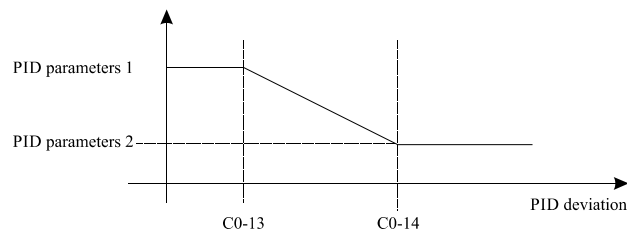

Diagram 5-26 PID parameters switchover

Code	Parameter Name	Setting Range	Default
C0-15	PID integral property	Unit's digit: Integral separated. 0: Invalid 1: Valid Ten's digit: Whether to stop integral operation when the output reaches the limit. 0: Continue integral operation 1: Stop integral operation	00

- Integral separation

If integral separation is set to valid, and the DI is defined as function 22 "PID integral pause". In this case, only proportional and differential operations take effect.

If integral separation is set to invalid, no matter whether the DI set with function 22 "PID integral pause" is ON or not, integral separation remains invalid.

- Stop integral

After the output has reached to maximum or minimum limit in PID operation, we can select to stop the integral operation or not. If we select to stop, it may help to reduce the PID overshoot.

Code	Parameter Name	Setting Range	Default
C0-16	PID initial value	0.0%~100.0%	0.0%
C0-17	PID initial value holding time	0.00s~650.00s	0.00s

When the frequency inverter starts up, the PID output initial value (C0-16), and sustain the holding time (C0-17), the PID start close-loop calculation.

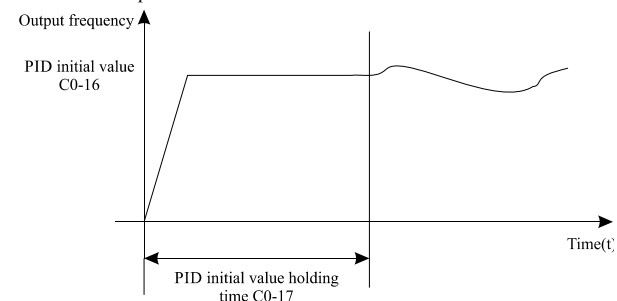

Diagram 5-27 PID initial value function

Code	Parameter Name	Setting Range	Default
C0-18	Frequency upper limit of PID reverse rotation	0.00 ~ maximum frequency	2.00 Hz

In some situations, only when the PID output frequency is a negative value (frequency inverter reverse rotation), PID setting and PID feedback can be equal. However, too high reverse rotation frequency is prohibited in some applications, and C0-18 is used to determine the reverse rotation frequency upper limit.

Code	Parameter Name	Setting Range	Default
C0-19	PID deviation limit	0.0%~100.0%	0.0%

If the deviation between PID feedback and PID setting is smaller than the value of C0-19, PID control stops. The small deviation between PID feedback and PID setting will make the output frequency stabilize, which is effective for some closed-loop control applications.

Code	Parameter Name	Setting Range	Default
C0-20	PID differential limit	0.00%~100.00%	0.10%

It is used to set the PID differential output range. In PID control, the differential operation may easily cause system oscillation. Thus, the PID differential regulation is restricted to a small range.

Code	Parameter Name	Setting Range	Default
C0-21	Maximum positive deviation between two PID outputs	0.00%~100.00%	1.00%
C0-22	Maximum negative deviation between two PID outputs	0.00%~100.00%	1.00%

This function is used to limit the deviation between two PID outputs (2 ms per PID output) to suppress the rapid change of PID output and stabilize the running of the frequency inverter.

C0-21 and C0-22 respectively are corresponding to the maximum absolute value of the output deviation in forward direction and in reverse direction.

Code	Parameter Name	Setting Range	Default
C0-23	PID feedback filter time	0.00s~60.00s	0.00s
C0-24	PID output filter time	0.00s~60.00s	0.00s

C0-23 is used to filter the PID feedback, helping to reduce interference on the feedback but slowing the response of the process closed-loop system.

C0-24 is used to filter the PID output frequency, helping to weaken sudden change of the frequency inverter output frequency but slowing the response of the process closed-loop system.

Code	Parameter Name	Setting Range	Default
C0-25	Detection value of PID feedback loss	0.0%: Not judging feedback loss 0.1%~100.0%	0.0%
C0-26	Detection time of PID feedback loss	0.0s~20.0s	0.0s

These parameters are used to judge whether PID feedback is lost.

If the PID feedback is smaller than the value of C0-25 and the lasting time exceeds the value of C0-26, the frequency inverter reports Err31 and acts according to the selected fault protection action.

Code	Parameter Name	Setting Range	Default
C0-27	PID operation at stop	0: No PID operation at stop 1: PID operation at stop	0

It is used to select whether to continue PID operation in the state of stopping. Generally, to set the PID operation stops when the frequency inverter stops.

5.15 Group C1: Multi-function

The Multi-function of EM11 has many functions. Besides multi-speed, it can be used as the setting source of the V/F separated voltage source and setting source of process PID. In addition, the Multi-function is relative value.

The simple PLC function is different from the EM11 user programmable function. Simple PLC can only complete simple combination of Multi-function.

Code	Parameter Name	Setting Range	Default
C1-00	Multi-function 0	-100.0%~100.0%	0.0%
C1-01	Multi-function 1	-100.0%~100.0%	0.0%
C1-02	Multi-function 2	-100.0%~100.0%	0.0%
C1-03	Multi-function 3	-100.0%~100.0%	0.0%
C1-04	Multi-function 4	-100.0%~100.0%	0.0%
C1-05	Multi-function 5	-100.0%~100.0%	0.0%
C1-06	Multi-function 6	-100.0%~100.0%	0.0%
C1-07	Multi-function 7	-100.0%~100.0%	0.0%
C1-08	Multi-function 8	-100.0%~100.0%	0.0%
C1-09	Multi-function 9	-100.0%~100.0%	0.0%

Code	Parameter Name	Setting Range	Default
C1-10	Multi-function 10	-100.0%~100.0%	0.0%
C1-11	Multi-function 11	-100.0%~100.0%	0.0%
C1-12	Multi-function 12	-100.0%~100.0%	0.0%
C1-13	Multi-function 13	-100.0%~100.0%	0.0%
C1-14	Multi-function 14	-100.0%~100.0%	0.0%
C1-15	Multi-function 15	-100.0%~100.0%	0.0%

Multi-function can be the setting source of frequency, V/F separated voltage and process PID. The Multi-function is relative value and ranges from -100.0% to 100.0%.

As frequency source, it is a percentage relative to the maximum frequency. As V/F separated voltage source, it is a percentage relative to the rated motor voltage. As process PID setting source, it does not require conversion.

Multi-function can be switched over based on different states of DI terminals. For details, see the descriptions of group b3.

Code	Parameter Name	Setting Range	Default
C1-16	Multi-function 0 source	0: Set by C1-00 1: AI1 2: AI2 3: AI3 4: Pulse setting(DI6) 5: PID 6: Set by preset frequency (b0-12), modified via terminal UP/ DOWN	0

It determines the setting channel of multi-function 0. You can perform convenient switchover between the setting channels. When multi-function or simple PLC is used as frequency source, the switchover between two frequency sources can be realized easily.

5.16 Group C2: Simple PLC

Code	Parameter Name	Setting Range	Default
C2-00	Simple PLC running mode	0: Stop after the Frequency inverter runs one cycle 1: Keep final values after the frequency inverter runs one cycle 2: Repeat after the frequency inverter runs one cycle	0

0: Stop after the frequency inverter runs one cycle

The frequency inverter stops after running one cycle, and will not start up until receiving another command.

1: Keep final values after the frequency inverter runs one cycle

The frequency inverter keeps the final running frequency and direction after running one cycle.

2: Repeat after the frequency inverter runs one cycle

The frequency inverter automatically starts another cycle after running one cycle, and will not stop until receiving the stop command.

Simple PLC can be either the frequency source or V/F separated voltage source.

When simple PLC is used as the frequency source, whether parameter values of C1-00 ~ C1-15 are positive or negative determines the frequency inverter running direction. If the parameter values are negative, it indicates that the frequency inverter runs in reverse direction.

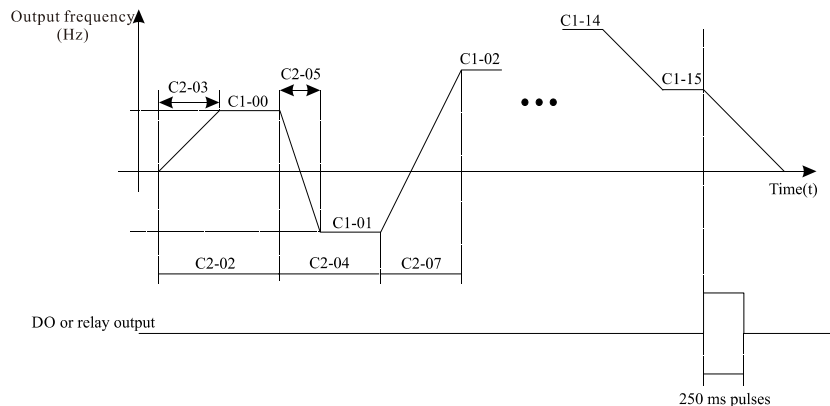

Diagram 5-28 Simple PLC when used as frequency source

Code	Parameter Name	Setting Range	Default
C2-01	Simple PLC record selection	Unit's digit: Record of power failure. 0: no record after power off 1: record after power off Ten's digit: Record of stopping. 0: no record after stopping 1: record after stopping	00

PLC record of power failure indicates that the frequency inverter memorizes the PLC running stage and running frequency before power failure, and frequency inverter will continue to run from the memorized stage after it is powered on again. If the unit's digit is set to 0, the frequency inverter restarts the PLC process after it is powered on again.

PLC record of stopping indicates that the frequency inverter records the PLC running stage and running frequency of stop, and frequency inverter will continue to run from the recorded stage after power on again. If the ten's digit is set to 0, the frequency inverter will restarts the PLC process after it power on again.

Code	Parameter Name	Setting Range	Default
C2-02	Running time of simple PLC Segment 0	0.0s(h)~6553.5s(h)	0.0s (h)
C2-03	Acceleration/deceleration time of simple PLC Segment 0	0~3	0
C2-04	Running time of simple PLC Segment 1	0.0s(h)~6553.5s(h)	0.0s (h)
C2-05	Acceleration/deceleration time of simple PLC Segment 1	0~3	0
C2-06	Running time of simple PLC Segment 2	0.0s(h)~6553.5s(h)	0.0s (h)
C2-07	Acceleration/deceleration time of simple PLC Segment 2	0~3	0

Code	Parameter Name	Setting Range	Default
C2-08	Running time of simple PLC Segment 3	0.0s(h)~6553.5s(h)	0.0s (h)
C2-09	Acceleration/deceleration time of simple PLC Segment 3	0~3	0
C2-10	Running time of simple PLC Segment 4	0.0s(h)~6553.5s(h)	0.0s (h)
C2-11	Acceleration/deceleration time of simple PLC Segment 4	0~3	0
C2-12	Running time of simple PLC Segment 5	0.0s(h)~6553.5s(h)	0.0s (h)
C2-13	Acceleration/deceleration time of simple PLC Segment 5	0~3	0
C2-14	Running time of simple PLC Segment 6	0.0s(h)~6553.5s(h)	0.0s (h)
C2-15	Acceleration/deceleration time of simple PLC Segment 6	0~3	0
C2-16	Running time of simple PLC Segment 7	0.0s(h)~6553.5s(h)	0.0s (h)
C2-17	Acceleration/deceleration time of simple PLC Segment 7	0~3	0
C2-18	Running time of simple PLC Segment 8	0.0s(h)~6553.5s(h)	0.0s (h)
C2-19	Acceleration/deceleration time of simple PLC Segment 8	0~3	0
C2-20	Running time of simple PLC Segment 9	0.0s(h)~6553.5s(h)	0.0s (h)
C2-21	Acceleration/deceleration time of simple PLC Segment 9	0~3	0
C2-22	Running time of simple PLC Segment 10	0.0s(h)~6553.5s(h)	0.0s (h)
C2-23	Acceleration/deceleration time of simple PLC Segment 10	0~3	0
C2-24	Running time of simple PLC Segment 11	0.0s(h)~6553.5s(h)	0.0s (h)
C2-25	Acceleration/deceleration time of simple PLC Segment 11	0~3	0
C2-26	Running time of simple PLC Segment 12	0.0s(h)~6553.5s(h)	0.0s (h)

Code	Parameter Name	Setting Range	Default
C2-27	Acceleration/deceleration time of simple PLC Segment 12	0~3	0
C2-28	Running time of simple PLC Segment 13	0.0s(h)~6553.5s(h)	0.0s (h)
C2-29	Acceleration/deceleration time of simple PLC Segment 13	0~3	0
C2-30	Running time of simple PLC Segment 14	0.0s(h)~6553.5s(h)	0.0s (h)
C2-31	Acceleration/deceleration time of simple PLC Segment 14	0~3	0
C2-32	Running time of simple PLC Segment 15	0.0s(h)~6553.5s(h)	0.0s (h)
C2-33	Acceleration/deceleration time of simple PLC Segment 15	0~3	0
C2-34	Time unit of simple PLC running	0: s (second) 1: h (hour)	0

5.17 Group C3: Swing Frequency, Fixed Length and Count

The swing frequency function is applied to the textile and chemical fiber fields and the applications where traversing and winding functions are required.

The swing frequency function indicates that the output frequency of the frequency inverter swings up and down with the setting frequency as the center. The trace of running frequency at the time axis is shown in the following figure.

The swing amplitude is set in C3-00 and C3-01. When C3-01 is set to 0, the swing amplitude is 0 and the swing frequency does not take effect.

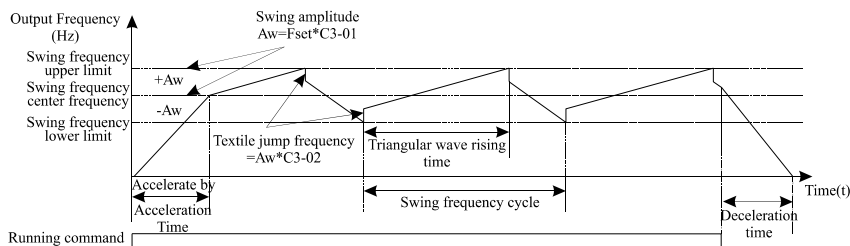

Diagram 5-29 Swing frequency control

Code	Parameter Name	Setting Range	Default
C3-00	Swing frequency setting mode	0: Relative to the central frequency 1: Relative to the maximum frequency	0

This parameter is used to select the basic value of the swing amplitude.

0: Relative to the central frequency (b0-07 frequency source selection)

It is variable swing amplitude system. The swing amplitude varies with the central frequency (setting frequency).

1: Relative to the maximum frequency (b0-13 maximum output frequency)

It is fixed swing amplitude system. The swing amplitude is fixed.

Code	Parameter Name	Setting Range	Default
C3-01	Swing frequency amplitude	0.0%~100.0%	0.0%
C3-02	Textile jump frequency amplitude of Swing running	0.0%~50.0%	0.0%

This parameter is used to set the jump frequency amplitude of swing running. The swing frequency is limited by the frequency upper limit and frequency lower limit.

- If swing frequency is relative to the central frequency (C3-00 = 0), the actual swing amplitude $AW = b0-07$ (Frequency source) \times C3-01 (Swing frequency amplitude).
- If swing frequency is relative to the maximum frequency (C3-00 = 1), the actual swing amplitude $AW = b0-13$ (Maximum frequency) \times C3-01 (Swing frequency amplitude).

The jump frequency is relative to the percentage of swing frequency amplitude. That is to say, jump frequency = Swing frequency running amplitude $AW \times$ C3-02 (Jump frequency amplitude).

- If Swing frequency amplitude is relative to the central frequency (C3-00 = 0), the jump frequency is a variable value.
- If Swing frequency amplitude is relative to the maximum frequency (C3-00 = 1), the jump frequency is a fixed value.

Code	Parameter Name	Setting Range	Default
C3-03	Swing frequency cycle	0.1s~3000.0s	10.0s
C3-04	Triangular wave rising time coefficient	0.1%~100.0%	50.0%

C3-03 specifies the time of a complete swing frequency cycle.

C3-04 specifies the time percentage of triangular wave rising time to C3-03 (Swing frequency cycle).

- Triangular wave rising time = C3-03 (Swing frequency cycle) \times C3-04 (Triangular wave rising time coefficient, unit: s)
- Triangular wave falling time = C3-03 (Swing frequency cycle) \times (1 - C3-04 Triangular wave rising time coefficient, unit: s)

Code	Parameter Name	Setting Range	Default
C3-05	Set length	0m~65535 m	1000 m
C3-06	Actual length	0m~65535 m	0 m
C3-07	Number of pulses per meter	0.1~6553.5	100.0

The above parameters are used for fixed length control.

The length information is collected by DI terminals. C3-06 (Actual length) is calculated by dividing the number of pulses collected by the DI terminal by C3-07 (Number of pulses each meter).

When the actual length C3-06 exceeds the set length in C3-05, the DO terminal set with function "Length reached" becomes ON.

During the fixed length control, the length reset operation can be performed via the DI terminal. For details, see the descriptions of b3-00 to b3-11.

Please set corresponding DI terminal with function 30 (Length count input) in applications. If the pulse frequency is high, DI6 terminal must be used.

Code	Parameter Name	Setting Range	Default
C3-08	Set count value	1~65535	1000
C3-09	Designated count value	1~65535	1000

The count value needs to be collected by DI terminal. Set the corresponding DI terminal with function 28(Counter input) in applications. If the pulse frequency is high, DI6 terminal must be used.

When the counting value reaches the set count value (C3-08), the DO terminal set with function (Set count value reached) becomes ON. Then the counter stops counting.

When the counting value reaches the designated counting value (C3-09), the DO terminal set with function (Designated count value reached) becomes ON. Then the counter continues to count until the set count value is reached.

5.18 Group d0: Motor 1 Parameters

Code	Parameter Name	Setting Range	Default
d0-00	Rated motor power	0.1kw~1000.0 kW	Model dependent
d0-01	Rated motor voltage	1V~2000 V	Model dependent
d0-02	Rated motor current	0.01A~655.35 A (Frequency inverter power ≤55 kW) 0.1A~6553.5 A (Frequency inverter power ≥75 kW)	Model dependent
d0-03	Rated motor frequency	0.01 Hz~ maximum frequency	50.00Hz
d0-04	Rated motor rotational speed	1rpm~65535rpm	Model dependent

Set the parameters according to the motor nameplate no matter whether V/F control or vector control is adopted.

To achieve better V/F or vector control performance, motor auto-tuning is required. The motor auto-tuning accuracy depends on the correct setting of motor nameplate parameters.

Code	Parameter Name	Setting Range	Default
d0-05	Stator resistance (asynchronous motor)	0.001 Ω ~65.535 Ω (frequency inverter power ≤ 55 kW) 0.0001 Ω ~6.5535 Ω (frequency inverter power ≥75 kW)	Model dependent
d0-06	Rotor resistance (asynchronous motor)	0.001 Ω ~65.535 Ω (frequency inverter power ≤ 55 kW) 0.0001 Ω ~6.5535 Ω (frequency inverter power ≥75 kW)	Model dependent
d0-07	Leakage inductive reactance (asynchronous motor)	0.01mH~655.35 mH (frequency inverter power ≤ 55 kW) 0.001mH~65.535 mH (frequency inverter power ≥75 kW)	Model dependent
d0-08	Mutual inductive reactance (asynchronous motor)	0.1mH~6553.5 mH (Frequency inverter power ≤ 55 kW) 0.01mH~655.35 mH (Frequency inverter power ≥75 kW)	Model dependent

Code	Parameter Name	Setting Range	Default
d0-09	No-load current (asynchronous motor)	0.01A ~ d0-02 (Frequency inverter power ≤55 kW) 0.1A to d0-02 (Frequency inverter power ≥75 kW)	Model dependent

The parameters in d0-05 ~ d0-09 are asynchronous motor parameters. These parameters are unavailable on the motor nameplate and are obtained by means of motor auto-tuning. Only d0-05 ~ d0-07 can be obtained through static motor auto-tuning. Through complete motor auto-tuning, encoder phase sequence and current loop PI can be obtained besides the parameters in d0-05 ~ d0-09.

When the "Rated motor power" (d0-00) or "Rated motor voltage" (d0-01) is changed; the frequency inverter automatically restores values of d0-05 ~ d0-09, to restore setting of these 5 parameters according to common standard Y series asynchronous motor.

If it is impossible to perform motor auto-tuning onsite, manually set the values of these parameters according to data provided by the motor manufacturer.

Code	Parameter Name	Setting Range	Default
d0-15	Stator resistance (synchronous motor)	0.001 Ω ~65.535 Ω (frequency inverter power ≤ 55 kW) 0.0001 Ω ~ 6.5535 Ω (frequency inverter power ≥75 kW)	Model dependent
d0-16	Shaft D inductance (synchronous motor)	0.01 mH ~655.35 mH (frequency inverter power ≤ 55 kW) 0.001~65.535 mH (Frequency inverter power ≥75 kW)	Model dependent
d0-17	Shaft Q inductance (synchronous motor)	0.01 mH ~655.35 mH (frequency inverter power ≤ 55 kW) 0.001 mH~65.535 mH (frequency inverter power ≥75 kW)	Model dependent
d0-18	Back EMF (synchronous motor)	0.1V~6553.5 V	Model dependent

The d0-15~d0-18 are synchronous motor parameters. These parameters are unavailable on the nameplate of most synchronous motors and can be obtained by means of "Synchronous motor no-load auto-tuning". Through "Synchronous motor with-load auto-tuning", only the encoder phase sequence and installation angle can be obtained.

Each time "Rated motor power" (d0-00) or "Rated motor voltage" (d0-01) is changed; the frequency inverter will automatically modify the values of d0-15~ d0-18.

You can also directly set the parameters based on the data provided by the synchronous motor manufacturer.

Code	Parameter Name	Setting Range	Default
d0-19	Encoder pulses per revolution	1~32767	1024

This parameter is used to set the pulses per revolution (PPR) of ABZ or UVW incremental encoder. In VC mode, the motor cannot run properly if this parameter is set incorrectly.

Code	Parameter Name	Setting Range	Default
d0-20	Encoder type	0: ABZ incremental encoder 1: Resolver 2: UVW incremental encoder 3: Reserved 4: Wire-saving UVW encoder	0

The EM11 supports multiple types of encoder. Different PG cards are required for different types of encoder. Select the appropriate PG card for the encoder used. Any of the five encoder types is applicable to synchronous motor. Only ABZ incremental encoder and resolver are applicable to asynchronous motor.

After installation of the PG card is complete, set this parameter properly based on the actual condition. Otherwise, the frequency inverter cannot run properly.

Code	Parameter Name	Setting Range	Default
d0-21	A/B phase sequence of ABZ incremental encoder	0: Forward 1: Reserve	0

This parameter is valid only for ABZ incremental encoder (d0-20 = 0) and is used to set the A/B phase sequence of the ABZ incremental encoder.

It is valid for both asynchronous motor and synchronous motor. The A/B phase sequence can be obtained through "Asynchronous motor complete auto-tuning" or "Synchronous motor no-load auto-tuning".

Code	Parameter Name	Setting Range	Default
d0-22	Encoder installation angle	0.0°~359.9°	0.0°

This parameter is applicable only to synchronous motor. It is valid for ABZ incremental encoder, UVW incremental encoder, resolver and wire-saving UVW encoder, but invalid for SIN/COS encoder.

It can be obtained through synchronous motor no-load auto-tuning or with-load auto-tuning. After installation of the synchronous motor is complete, the value of this parameter must be obtained by motor auto-tuning. Otherwise, the motor cannot run properly.

Code	Parameter Name	Setting Range	Default
d0-23	U, V, W phase sequence of UVW encoder	0: Forward 1: Reverse	0
d0-24	UVW encoder angle offset	0.0°~359.9°	0.0°

These two parameters are valid only when the UVW encoder is applied to a synchronous motor. They can be obtained by synchronous motor no-load auto-tuning or with-load auto-tuning. After installation of the synchronous motor is complete, the values of these two parameters must be obtained by motor auto-tuning. Otherwise, the motor cannot run properly.

Code	Parameter Name	Setting Range	Default
d0-28	Number of pole pairs of resolver	1~99	1

If a resolver is applied, set the number of pole pairs properly.

Code	Parameter Name	Setting Range	Default
d0-29	Encoder wire-break fault detection time	0.0s: No action 0.1s~10.0s	0.0s

This parameter is used to set the detecting time that a wire-break faults. If it is set to 0.0s, the frequency inverter does not detect the encoder wire-break fault. If the duration time of the encoder wire-break fault detected by the frequency inverter exceeds the time set in this parameter, the frequency inverter reports Err20.

Code	Parameter Name	Setting Range	Default
d0-30	Motor 1 auto-tuning selection	0: No auto-tuning 1: Asynchronous motor static auto-tuning 2: Asynchronous motor complete auto-tuning 11: Synchronous motor with-load auto-tuning 12: Synchronous motor no-load auto-tuning	0

0: No auto-tuning

Auto-tuning is prohibited.

1: Asynchronous motor static auto-tuning

It is applicable to scenarios where complete auto-tuning cannot be performed because the asynchronous motor cannot be disconnected from the load.

Before performing static auto-tuning, properly set the motor type and motor nameplate parameters of d0-00 ~ d0-04 firstly. The frequency inverter will obtain parameters of d0-05 ~ d0-07 by static auto-tuning.

Action guide: Set this parameter to 1, and press **RUN** key. Then, the frequency inverter starts static auto-tuning.

2: Asynchronous motor complete auto-tuning

To perform this type of auto-tuning, ensure that the motor is disconnected from the load. During the process of complete auto-tuning, the frequency inverter performs static auto-tuning first and then accelerates to 80% of the rated motor frequency within the acceleration time set in b0-21. The frequency inverter keeps running for a certain period and then decelerates to stop with deceleration time set in b0-22.

Before performing complete auto-tuning, properly set the motor type, motor nameplate parameters of b0-00 and d0-00~ d0-04, "Encoder type" (d0-20) and "Encoder pulses per revolution" (d0-19) first.

The frequency inverter will obtain motor parameters of d0-05 ~ d0-09, "A/B phase sequence of ABZ incremental encoder" (d0-21) and vector control current loop PI parameters of d1-10 ~ d1-13 by complete auto-tuning.

Action guide: Set this parameter to 2, and press **RUN** key. Then, the frequency inverter starts complete auto-tuning.

11: Synchronous motor with-load auto-tuning

It is applicable to site where the synchronous motor cannot be disconnected from the load. During with-load auto-tuning, the motor rotates at the speed of 10 RPM.

Before performing with-load auto-tuning, properly set the motor type and motor nameplate parameters of b0-00 and d0-00 ~ d0-04 first.

By with-load auto-tuning, the frequency inverter obtains the initial position angle of the synchronous motor, which is a necessary prerequisite of the motor's normal running. Before the first use of the synchronous motor after installation, motor auto-tuning must be performed.

Action guide: Set this parameter to 11, and press **RUN** key. Then, the frequency inverter starts with-load auto-tuning.

12: Synchronous motor no-load auto-tuning

If the synchronous motor can be disconnected from the load, no-load auto-tuning is recommended, which will achieve better running performance compared with with-load auto-tuning.

During the process of no-load auto-tuning, the frequency inverter performs with-load auto-tuning firstly and then accelerates to 80% of the rated motor frequency with the acceleration time set in b0-21. The frequency inverter keeps running for a certain period and then decelerates to stop with the deceleration time set in b0-22.

Before performing no-load auto-tuning, properly set the motor type, motor nameplate parameters of b0-00 and d0-00 ~ d0-04, "Encoder type" (d0-20) and "Encoder pulses per revolution" (d0-19) and "Number of pole pairs of resolver" (d0-28) first.

The frequency inverter will obtain motor parameters of d0-15 ~ d0-18, encoder related parameters of d0-21 ~ d0-24 and vector control current loop PI parameters of d1-10 ~ d1-13 by no-load auto-tuning.

Action guide: Set this parameter to 12, and press **RUN key**. Then, the frequency inverter starts no-load auto-tuning.

Note: Motor auto-tuning can be performed only in operation panel mode.

5.19 Group d1: Motor 1 vector control parameters

The Group d1 function codes are only valid for motor 1 vector control. It is invalid for motor 2 parameters or motor 1 V/F control.

Code	Parameter Name	Setting Range	Default
d1-00	Speed/Torque control selection	0: Speed control 1: Torque control	0

It is used to select the frequency inverter's control mode: speed control or torque control.

The EM11 provides DI terminals with two torque related functions, function 21 (Torque control prohibited) and function 20 (Speed control/Torque control switchover). The two DI terminals need to be used together with d1-00 to implement speed control/torque control switchover.

If the DI terminal set with function 20 (Speed control/Torque control switchover) is OFF, the control mode is determined by d1-00. If the DI terminal set with function 20 is ON, the control mode is reverse to the value of d1-00.

However, if the DI terminal with function 21 (Torque control prohibited) is ON, the frequency inverter is fixed to run in the speed control mode.

Code	Parameter Name	Setting Range	Default
d1-01	Speed loop proportional gain 1(Kp1)	0.01~10.00	0.30
d1-02	Speed loop integral time 1(Ti1)	0.01s~10.00s	0.50s
d1-03	Switchover frequency 1	0.00 ~ d1-06	5.00 Hz
d1-04	Speed loop proportional gain 2(KP2)	0.01~10.00	0.20

Code	Parameter Name	Setting Range	Default
d1-05	Speed loop integral time 2(Ti2)	0.01s~10.00s	1.00s
d1-06	Switchover frequency 2	d1-03~ maximum output frequency	10.00 Hz

Speed loop PI parameters vary with running frequencies of the frequency inverter.

- If the running frequency is less than or equal to "Switchover frequency 1" (d1-03), the speed loop PI parameters are d1-01 and d1-02.
- If the running frequency is equal to or greater than "Switchover frequency 2" (d1-06), the speed loop PI parameters are d1-04 and d1-05.
- If the running frequency is between d1-03 and d1-06, the speed loop PI parameters are obtained from the linear switchover between the two groups of PI parameters, as shown in Diagram 6-30.

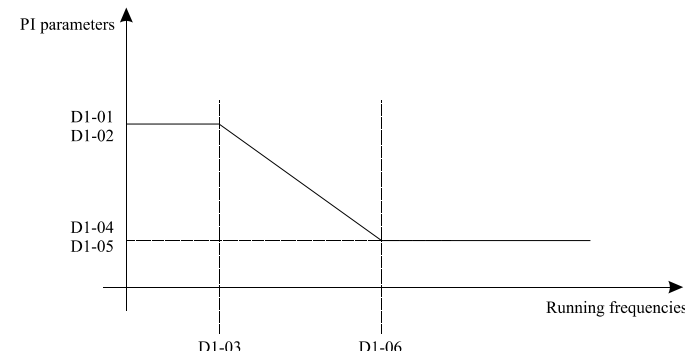

Diagram 5-30 Relationship between running frequencies and PI parameters

The speed dynamic response characteristics in vector control can be adjusted by setting the proportional gain and integral time of the speed regulator.

To achieve a faster system response, increase the proportional gain and reduce the integral time. Be aware that this may lead to system oscillation. The recommended adjustment method is as follows:

If the factory setting cannot meet the requirements, make proper adjustment. Increase the proportional gain first to ensure that the system does not oscillate, and then reduce the integral time to ensure that the system has quick response and small overshoot.

Note: Improper PI parameter setting may cause too large speed overshoot, and overvoltage fault may even occur when the overshoot drops.

Code	Parameter Name	Setting Range	Default
d1-07	Speed loop integral property	0: Integral separation disabled 1: Integral separation enabled	0
d1-10	Excitation current loop proportional gain	0~30000	2000
d1-11	Excitation current loop integral gain	0~30000	1300
d1-12	Torque current loop proportional gain	0~30000	2000

Code	Parameter Name	Setting Range	Default
d1-13	Torque current loop integral gain	0~30000	1300

These are current loop PI parameters for vector control. These parameters are automatically obtained through "Asynchronous motor complete auto-tuning" or "Synchronous motor no-load auto-tuning", and need not be modified.

The dimension of the current loop integral regulator is integral gain rather than integral time. Note that too large current loop PI gain may lead to oscillation of the entire control loop.

Therefore, when current oscillation or torque fluctuation is great, manually decrease the proportional gain or integral gain here.

Code	Parameter Name	Setting Range	Default
d1-14	Motor running torque upper limit source in speed control mode	0: d1-16 1: AI1 2: AI2 3: AI3 4: Pulse setting (DI6) 5: Communication setting	0
d1-15	Braking torque upper limit source in speed control mode	0: d1-17 1: AI1 2: AI2 3: AI3 4: Pulse setting (DI6) 5: Communication setting	0
d1-16	Digital setting of motor running torque limit	0.0%~200.0%	150.0%
d1-17	Digital setting of braking torque limit	0.0%~200.0%	150.0%

In the speed control mode, the maximum output torque of the frequency inverter is restricted by d1-14. If the torque upper limit is analog, pulse or communication setting, 100% of the setting corresponds to the value of d1-16, and 100% of the value of d1-16 corresponds to the frequency inverter rated torque.

For details on the AI1, AI2 and AI3 setting, see the description of the AI curves. For details on the pulse setting, see the description of b5-00 ~ b5-04.

Code	Parameter Name	Setting Range	Default
d1-18	Motor running slip gain	50%~200%	100%

For SVC, it is used to adjust speed stability accuracy of the motor. When the motor with load runs at a very low speed, increase the value of this parameter; when the motor with load runs at a very fast speed, decrease the value of this parameter.

For VC, it is used to adjust the output current of the frequency inverter with same load.

Code	Parameter Name	Setting Range	Default
d1-21	PM field weakening mode of synchronous motor	0: Invalid field weakening 1: Direct calculation 2: Automatic adjustment	1
d1-22	PM field weakening depth of synchronous motor	50%~500%	100%
d1-23	Maximum current of PM field weakening	1%~300%	50%
d1-24	PM Field weakening automatic adjustment gain	0.10~5.00	1.00
d1-25	PM Field weakening integral multiple	2~10	2

These parameters are used to set field weakening control for the synchronous motor.

If d1-21 is set to 0, field weakening control on the synchronous motor is disabled. In this case, the maximum rotational speed is related to the frequency inverter DC bus voltage. If the motor's maximum rotational speed cannot meet the requirements, enable the field weakening function to increase the speed.

The EM11 provides two field weakening modes: direct calculation and automatic adjustment.

- In direct calculation mode, directly calculate the demagnetized current and manually adjust the demagnetized current by parameter d1-22. The smaller the demagnetized current is, the smaller the total output current is. However, the desired field weakening effect may not be achieved.
- In automatic adjustment mode, the best demagnetized current is selected automatically.

This may influence the system dynamic performance or cause instability.

The adjustment speed of the field weakening current can be changed by modifying the values of d1-24 and d1-25. A very quick adjustment may cause instability. Therefore, generally do not modify them manually.

Code	Parameter Name	Setting Range	Default
d1-26	Torque setting source in torque control	0: Digital setting (d1-27) 1: AI1 2: AI2 3: AI3 4: Pulse setting (DI6) 5: Communication setting 6: MIN (AI1, AI2) 7: MAX (AI1, AI2) Full range of values 1~7 corresponds to the digital setting of d1-27.	0
d1-27	Torque digital setting in torque control	-200.0%~200.0%	100.0%

The d1-26 is used to set the torque setting source. There are a total of eight torque setting sources.

The torque setting is a relative value. 100.0% corresponds to the frequency inverter's rated torque. The setting range is -200.0% ~ 200.0%, indicating the frequency inverter's maximum torque is twice of the frequency inverter's rated torque.

If the torque setting is positive, the frequency inverter rotates in forward direction. If the torque setting is negative, the frequency inverter rotates in reverse direction.

0: Digital setting (d1-27)

The target torque directly uses the value set in d1-27.

1:AI1**2:AI2****3:AI3**

The target torque is decided by analog input. The EM11 control board provides two AI terminals (AI1, AI2). Another AI terminal (AI3) is provided by the I/O extension card. AI1 is 0V~10 V voltage input, AI2 is 0V~10 V voltage input or 4mA~20mA current input decided by jumper on the control board, and AI3 is -10 V ~ +10 V voltage input.

For the details of AI Curve setting, please refer to the description of analog input parameters.

When AI is used as frequency setting source, the corresponding value 100% of voltage/ current input corresponds to the value of d1-27.

4: Pulse setting (DI6)

The target torque is set by DI6 (high-speed pulse). The pulse setting signal specification is 9V~30 V (voltage range) and 0 kHz~100 kHz (frequency range). The pulse can only be input via DI6. The relationship (which is a two-point line) between DI6 input pulse frequency and the corresponding value is set in b5-00 ~ b5-03. The corresponding value 100.0% of pulse input corresponds to the percentage of d1-27.

5: Communication setting

The target torque is set by means of communication.

Code	Parameter Name	Setting Range	Default
d1-30	Forward maximum frequency in torque control	0.00 Hz ~ maximum frequency(b0-13)	50.00 Hz
d1-31	Reverse maximum frequency in torque control	0.00 Hz ~ maximum frequency(b0-13)	50.00 Hz

The two parameters are used to set the maximum frequency in forward or reverse rotation in torque control mode.

In torque control, if the load torque is smaller than the motor output torque, the motor's rotational speed will rise continuously. To avoid runaway of the mechanical system, the motor maximum rotating speed must be limited in torque control.

You can implement continuous change of the maximum frequency in torque control dynamically by controlling the frequency upper limit.

Code	Parameter Name	Setting Range	Default
d1-32	Acceleration time in torque control	0.00s~120.00s	0.10s
d1-33	Deceleration time in torque control	0.00s~120.00s	0.10s

In torque control, the difference between the motor output torque and the load torque determines the speed change rate of the motor and load. The motor rotational speed may change quickly and this will result in noise or too large mechanical stress. The setting of acceleration/deceleration time in torque control makes the motor rotational speed change softly.

However, in applications requiring rapid torque response, set the acceleration/deceleration time in torque control to 0.00s. For example, two frequency inverters are connected to drive the same load. To balance the load allocation, set one frequency inverter as master in speed control and the other as slave in torque control. The slave receives the master's output torque as the torque command and must follow the master rapidly. In this case, the acceleration/deceleration time of the slave in torque control is set to 0.0s.

5.20 Group d2: Motor 1 V/F Control Parameters

Group d2 is valid only for V/F control.

The V/F control mode is applicable to low requirement load applications (fan or pump) or applications where one frequency inverter operates multiple motors or there is a large difference between the frequency inverter power and the motor power.

Code	Parameter Name	Setting Range	Default
d2-00	V/F curve setting	0: Linear V/F 1: Multi-point V/F 2: Square V/F 3: 1.2-power V/F 4: 1.4-power V/F 6: 1.6-power V/F 8: 1.8-power V/F 10: V/F complete separation 11: V/F half separation	0

0: Linear V/F

It is applicable to common constant torque load.

1: Multi-point V/F

It is applicable to special load such as dehydrator and centrifuge. Any relationship V/F curve can be obtained by setting parameters of d2-03 ~ d2-08.

2: Square V/F

It is applicable to centrifugal loads such as fan and pump.

3 ~ 8: V/F curve between linear V/F and square V/F**10: V/F complete separation**

In this mode, the output frequency and output voltage of the frequency inverter are independent. The output frequency is determined by the frequency source, and the output voltage is determined by "Voltage source for V/F separation" (d2-12).

It is applicable to induction heating, inverse power supply and torque motor control.

11: V/F half separation

In this mode, V and F are proportional and the proportional relationship can be set in d2-12. The relationship between V and F are also related to the "rated motor voltage" and "rated motor frequency".

Assume that the voltage source input is X (0% ~100%), the relationship between V and F is:

$$V/F = 2 \times X \times (\text{Rated motor voltage}) / (\text{Rated motor frequency})$$

Code	Parameter Name	Setting Range	Default
d2-01	Torque boost	0.0% (torque auto-boost) 0.1%~30.0%	0

Code	Parameter Name	Setting Range	Default
d2-02	Cut-off frequency of torque boost	0.0%~80.0% Actual cut-off frequency= Motor rated frequency*d2-02	50.0%

To compensate the low frequency torque characteristics of V/F control, you can boost the output voltage of the frequency inverter at low frequency by modifying d2-01.

If the torque boost is set to too large, the motor is easily overheated, and the frequency inverter easily suffers over current.

If the load is large and the motor startup torque is insufficient, increase the value of d2-01. If the load is small, decrease the value of d2-01. If it is set to 0.0, the frequency inverter performs automatic torque boost. In this case, the frequency inverter automatically calculates the torque boost value based on motor parameters including the stator resistance.

d2-02 specifies the frequency under which torque boost is valid. Torque boost becomes invalid when this frequency is exceeded, as shown in the following figure.

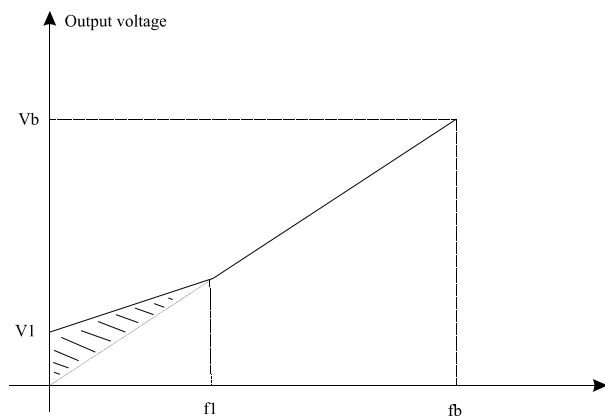

V1: Voltage of manual torque boost
Vb: Maximum output voltage
f1: Cutoff frequency of manual torque boost
fb: Rated running frequency

Diagram 5-31 Manual torque boost

Code	Parameter Name	Setting Range	Default
d2-03	Multi-point V/F frequency 1 (F1)	0.00 Hz ~ d2-05	0.00 Hz
d2-04	Multi-point V/F voltage 1 (V1)	0.0%~100.0%	0.0%
d2-05	Multi-point V/F frequency 2 (F2)	d2-03 to d2-07	0.00 Hz
d2-06	Multi-point V/F voltage 2 (V2)	0.0%~100.0%	0.0%
d2-07	Multi-point V/F frequency 3 (F3)	d2-05 ~ maximum frequency	0.00 Hz
d2-08	Multi-point V/F voltage 3 (V3)	0.0%~100.0%	0.0%

When d2-00 set to 1, these six parameters are used to define the multi-point V/F curve.

The multi-point V/F curve is set based on the motor's load characteristic. The relationship between voltages and frequencies is: $V1 < V2 < V3$, $F1 < F2 < F3$. Diagram 6-32 shows the setting of multi-point V/F curve. At low frequency, higher voltage may cause motor overheat or even burnt and cause frequency inverter over current stall or over current protection.

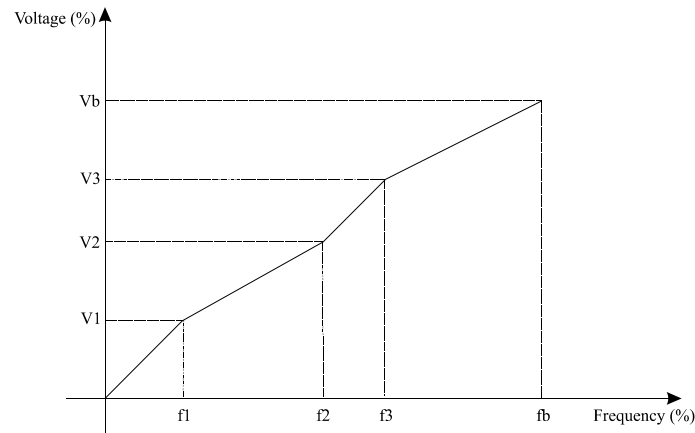

V1-V3: 1st, 2nd and 3rd voltage percentages of multi-point V/F
Vb: Rated motor voltage
f1-f3: 1st, 2nd and 3rd voltage percentages of multi-point V/F
fb: Rated motor running frequency

Diagram 5-32 Setting of multi-point V/F curve

Code	Parameter Name	Setting Range	Default
d2-09	V/F slip compensation coefficient	0.0%~200.0%	0.0%

This parameter is valid only for the asynchronous motor.

It can compensate the rotational speed slip of the asynchronous motor when the load of the motor increases, stabilizing the motor speed in case of load change.

If this parameter is set to 100%, it indicates that the compensation when the motor bears rated load is the rated motor slip. The rated motor slip is automatically obtained by the frequency inverter through calculation based on the rated motor frequency and rated motor rotational speed in group d0.

Generally, if the motor rotational speed is different from the target speed, slightly adjust this parameter.

Code	Parameter Name	Setting Range	Default
d2-10	V/F oscillation suppression gain	0~100	0

The setting method for this parameter is to set as small as possible on the premise of effective oscillation suppression, to avoid the badly effect for V/F running. When there is no oscillation of the motor, please set the gain to 0. Only when there is obvious oscillation of the motor, you can increase the gain properly. The larger the gain is, more obviously the effect of oscillation suppression is.

When the oscillation suppression function is used, the parameters of motor rated current and no-load current must be set correctly, or the effect of oscillation suppression is poor.

Code	Parameter Name	Setting Range	Default
d2-12	Voltage source for V/F separation	0: Digital setting (d2-13) 1: AI1 2: AI2 3: AI3 4: Pulse setting (DI6) 5: Multi-function 6: Simple PLC 7: PID 8: Communication setting (Note: 100.0% corresponds to the rated motor voltage)	0
d2-13	Voltage digital setting for V/F separation	0 V ~ rated motor voltage	0 V

V/F separation is generally applicable to these sites, such as induction heating, inverse power supply and motor torque control.

If V/F separated control is enabled, the output voltage can be set in d2-13 or by analog, Multi-function, simple PLC, PID or communication. If you set the output voltage by means of non-digital setting, 100% of the setting corresponds to the rated motor voltage. If a negative percentage is set, its absolute value is used as the effective value.

0: Digital setting (d2-13)

The output voltage is set directly in d2-13.

1: AI1;

2: AI2;

3: AI3

The output voltage is set by analog input terminals.

4: Pulse setting (DI6)

The output voltage is set by pulses of the terminal DI6.

Pulse setting specification: voltage range 9V~30 V, frequency range 0kHz~100 kHz

5: Multi-function

6: Simple PLC

If the voltage source is simple PLC mode, parameters in group FC must be set to determine the setting output voltage.

7: PID

The output voltage is generated based on PID closed loop. For details, see the description of PID in group C0.

8: Communication setting

The output voltage is set by the host computer by means of communication.

The voltage source for V/F separation is selected in the similar way to the frequency source selection. For details, see b0-03 (main frequency source X specification). 100.0% of the setting in each mode corresponds to the rated motor voltage. If the corresponding value is negative, its absolute value is used.

Code	Parameter Name	Setting Range	Default
d2-14	Voltage rise time of V/F separation	0.0s~1000.0s Note: It indicates the time for the voltage rising from 0 V ~ rated motor voltage.	0.0s

d2-14 indicates the time required for the output voltage to rise from 0 V to the rated motor voltage shown

as t1 in the following figure.

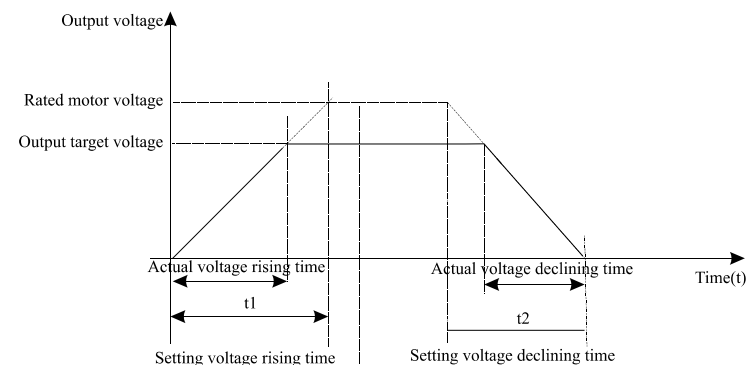

Diagram 5-33 Voltage of V/F separation

5.21 Group d3 to d5: Relevant parameters of motor 2

EM11 series support the switchover of two groups of motor parameters, and the two motors can separately set the motor nameplate parameters, motor auto-tuning parameters, V/F control or vector control mode, the related parameters of encoder and the related performance parameters of V/F control or vector control mode.

For the setting of motor 2, please refer to the relevant description of motor1 parameters.

5.22 Group d6: Control Optimization Parameters

Code	Parameter Name	Setting Range	Default
d6-00	Carrier frequency	0.5kHz~15.0 kHz	Model dependent

It is used to adjust the carrier frequency of the frequency inverter, helping to reduce the motor noise, avoiding the resonance of the mechanical system, and reducing the leakage current to earth and interference generated by the frequency inverter.

If the carrier frequency is low, output current has high harmonic wave, and then the motor will increase power loss and temperature rising.

If the carrier frequency is higher, the power loss and temperature rising of the motor will decline. However, the frequency inverter will have an increasing in power loss, temperature rising and interference.

Adjusting the carrier frequency will exert influences on the aspects listed in the following table.

Table 6-1 Influences of carrier frequency adjustment

Carrier frequency	Low →	High
Motor noise	Large →	Small
Output current	Bad →	Good
Motor temperature	High →	Low
Frequency inverter	Low →	High
Leakage current	Small →	Large
External radiation interference	Small →	Large

The factory setting of carrier frequency varies with the frequency inverter power. If you need to modify the carrier frequency, note that if the set carrier frequency is higher than factory setting, it will lead to an increase in temperature rise of the frequency inverter's heatsink. In this case, you need to de-rate the frequency inverter. Otherwise, the frequency inverter may overheat and alarm.

Code	Parameter Name	Setting Range	Default
d6-01	DPWM switchover frequency upper limit	0.00Hz~15.00 Hz	12.00 Hz

This parameter is valid only for V/F control.

It is used to determine the wave modulation mode in V/F control of asynchronous motor. If the frequency is lower than the value of this parameter, the waveform is 7-segment continuous modulation. If the frequency is higher than the value of this parameter, the waveform is 5-segment intermittent modulation.

The 7-segment continuous modulation causes more wastage of IGBT switches of the frequency inverter but smaller current ripple. The 5-segment intermittent modulation causes less wastage of IGBT switches of the frequency inverter but larger current ripple. This parameter may lead to motor running instability at high frequency. Do not modify this parameter generally.

For instability of V/F control, refer to parameter d2-10. For wastage of frequency inverter and temperature rising, please refer to parameter d6-00.

Code	Parameter Name	Setting Range	Default
d6-02	PWM modulation mode	0: Asynchronous modulation 1: Synchronous modulation	0

This parameter is valid only for V/F control.

Synchronous modulation indicates that the carrier frequency varies linearly with the change of the output frequency, ensuring that the ratio of carrier frequency to output frequency remains unchanged. Synchronous modulation is generally used at high output frequency, which helps improve the output voltage quality.

At low output frequency (100 Hz or lower), synchronous modulation is not required. This is because ratio of carrier frequency to output frequency is still high, and asynchronous modulation is more superior at such low running frequency.

Synchronous modulation takes effect only when the running frequency is higher than 85 Hz. If the frequency is lower than 85 Hz, asynchronous modulation is always valid.

Code	Parameter Name	Setting Range	Default
d6-03	Carrier frequency adjustment with temperature	0: No 1: Yes	1

It is used to set whether the carrier frequency is adjusted based on the temperature. The frequency inverter automatically reduces the carrier frequency when detecting that the heatsink temperature is high. The frequency inverter restores the carrier frequency to the set value when the heatsink temperature becomes normal. This function is used to reduce the overheat alarms.

Code	Parameter Name	Setting Range	Default
d6-04	Random PWM depth	0: Random PWM invalid 1~10: Random PWM carrier frequency depth	0

The setting of random PWM depth can make the motor shrill noise to soft and reduce the electromagnetic interference to other equipments. If this parameter is set to 0, random PWM is invalid.

Code	Parameter Name	Setting Range	Default
d6-05	Dead zone compensation mode selection	0: No compensation 1: Compensation mode 1 2: Compensation mode 2	1

Generally, you need not modify this parameter. Try to use a different compensation mode only when there is special requirement on the output voltage waveform quality or oscillation occurs on the motor.

For high power frequency inverter, compensation mode 2 is recommended.

Code	Parameter Name	Setting Range	Default
d6-06	SVC mode selection	0: SVC mode 0 1: SVC mode 1	1

SVC mode 0: Used in the application that high speed stability required.

SVC mode 1: Used in the application that high torque control linearity required.

5.23 Group U0: Monitoring Parameters

Group U0 is used to monitor the frequency inverter's running state. You can view the parameter values by using operation panel, convenient for on-site commissioning, or from the host computer by means of communication (address: 0x7000 ~ 0x7044).

U0-00 ~ U0-31 are the monitoring parameters in the running and stop state defined by b9-02 and b9-03.

For more details, see Table 6-1.

Code	Parameter Name	Display Range
U0-00	Running frequency	0.00~300.00 Hz (b0-11 = 2)
U0-01	Setting frequency	0.00~3000.0 Hz (b0-11 = 1)

These two parameters display the absolute value of theoretical running frequency and set frequency. For the actual output frequency of the frequency inverter, see U0-19.

Code	Parameter Name	Display Range
U0-02	DC Bus voltage	0.0~3000.0 V

It displays the frequency inverter's DC bus voltage.

Code	Parameter Name	Display Range
U0-03	Output voltage	0V~1140 V

It displays the frequency inverter's output voltage in the running state.

Code	Parameter Name	Display Range
U0-04	Output current	0.00A~655.35 A (Frequency inverter power ≤ 55 kW) 0.0A~6553.5 A (Frequency inverter power > 55 kW)

It displays the frequency inverter's output current in the running state.

Code	Parameter Name	Display Range
U0-05	Output power	0~32767

It displays the frequency inverter's output power in the running state.

Code	Parameter Name	Display Range
U0-06	Output torque	-200.0%~200.0%

It displays the frequency inverter's output torque in the running state.

Code	Parameter Name	Display Range
U0-07	DI state	-0~32767

It displays the present state of DI terminals. After the value is converted into a binary number, each bit corresponds to a DI. "1" indicates high level signal, and "0" indicates low level signal. The corresponding relationship between bits and DIx is described in the following table.

Bit0	Bit1	Bit2	Bit3	Bit4	Bit5	Bit6	Bit7	Bit8	Bit9
DI1	DI2	DI3	DI4	DI5	DI6	DI7	DI8	DI9	DI10
Bit10	Bit11	Bit12	Bit13	Bit10	Bit11	Bit12	Bit13	Bit14	Bit15
VDI1	VDI2	VDI3	VDI4	VDI1	VDI2	VDI3	VDI4	VDI5	

Code	Parameter Name	Display Range
U0-08	DO state	0~1023

It indicates the present state of DO terminals. After the value is converted into a binary number, each bit corresponds to a DO terminal. "1" indicates high level signal, and "0" indicates low level signal. The corresponding relationship between bits and DOx is described in the following table.

Table 6-15 Corresponding relationship between bits and DOs

Bit0	Bit1	Bit2	Bit3	Bit4	Bit5
DO3	Relay 1	Relay 2	DO1	DO2	VDO1
Bit6	Bit7	Bit8	Bit9	Bit10	Bit11
VDO2	VDO3	VDO4	VDO5		

Code	Parameter Name	Display Range
U0-14	Load speed display	0~65535

For more details, see the description of b9-06.

Code	Parameter Name	Display Range
U0-15	PID setting	0~65535
U0-16	PID feedback	0~65535

They display the PID setting value and PID feedback value.

- PID setting = PID setting (percentage) × C0-05
- PID feedback = PID feedback (percentage) × C0-05

Code	Parameter Name	Display Range
U0-18	Input pulse frequency	0.00kHz ~100.00 kHz

It displays the high-speed pulse sampled frequency of DI6, in minimum unit of 0.01 kHz.

Code	Parameter Name	Display Range
U0-19	Feedback speed, unit:0.01Hz	-3000.0Hz~3000.0 Hz -300.00Hz~300.00 Hz

It displays the actual output frequency of the frequency inverter.

- If b0-11 (frequency command resolution) is set to 1, the display range is -3000.00~3000.00 Hz.
- If b0-11 (frequency command resolution) is set to 2, the display range is -300.00Hz~300.00 Hz.

Code	Parameter Name	Display Range
U0-20	Remaining running time	0.0min~6500.0 min

It displays the remaining running time when the timing operation is enabled. For details on timing operation, refer to b2-28 ~ b2-30.

Code	Parameter Name	Display Range
U0-21	AI1 voltage before correction	0.00V~10.57 V
U0-22	AI2 voltage before correction	0.00V~10.57 V
U0-23	AI3 voltage before correction	-10.57V~10.57 V

They display the AI sampling voltage actual value. The actually used voltage is obtained after linear correction, which will reduce the deviation between the sampled voltage and the actual input voltage. For actual corrected voltage, see U0-09, U0-10 and U0-11. Refer to group b8 for the correction mode.

Code	Parameter Name	Display Range
U0-24	Linear speed	0.0min~65535m/min

It displays the linear speed of the DI6 high-speed pulse sampling. The unit is meter per minute (meter/min). The linear speed is calculated according to the actual number of pulses sampled per minute and C3-07 (Number of pulses per meter).

Code	Parameter Name	Display Range
U0-27	Communication setting value	-100.00%~100.00%

It displays the data written in by means of the communication address 0x1000.

Code	Parameter Name	Display Range
U0-28	Encoder feedback speed	-300.00Hz~300.00 Hz -3000.0Hz~3000.0 Hz

It displays the motor running frequency measured by the encoder.

- If b0-11 (frequency command resolution) is 1, the display range is -3000.0Hz~3000.0 Hz.
- If b0-11 (frequency command resolution) is 2, the display range is -300.00Hz~300.00 Hz.

Code	Parameter Name	Display Range
U0-29	Main frequency X	0.00Hz~300.00 Hz 0.0Hz~3000.0 Hz

It displays the setting of main frequency X.

- If b0-11 (frequency command resolution) is 1, the display range is -3000.0Hz~3000.0 Hz.
- If b0-11 (frequency command resolution) is 2, the display range is -300.00Hz~300.00 Hz.

Code	Parameter Name	Display Range
U0-30	Auxiliary frequency Y	0.00Hz~300.00 Hz 0.0Hz~3000.0 Hz

It displays the setting of auxiliary frequency Y.

- If b0-11 (frequency command resolution) is 1, the display range is -3000.0Hz~3000.0 Hz.
- If b0-11 (frequency command resolution) is 2, the display range is -300.00Hz~300.00 Hz.

Code	Parameter Name	Display Range
U0-32	Synchronous motor rotor position	0.0°~ 359.9°

It displays the rotor position of the synchronous motor.

Code	Parameter Name	Display Range
U0-33	Motor temperature	0°C~200°C

It displays the motor temperature obtained by means of AI3 sampling. For the motor temperature detection details, see bb-25.

Code	Parameter Name	Display Range
U0-34	Target torque	-200.0%~200.0%

It displays the present torque upper limit value.

Code	Parameter Name	Display Range
U0-35	Resolver position	0~4095

It displays the current resolver position.

Code	Parameter Name	Display Range
U0-36	Power factor angle	-

It displays the present power factor angle.

Code	Parameter Name	Display Range
U0-37	ABZ position	0~65535

It displays the phase A and B pulse counting of the present ABZ or UVW encoder. This value is four times the number of pulses that the encoder runs. For example, if the display is 4000, the actual number of pulses that the encoder runs is 4000/4 = 1000.

The value increase when the encoder rotates in forward direction and decreases when the encoder rotates in reverse direction. After increasing to 65535, the value starts to increase from 0 again. After decreasing to 0, the value starts to decrease from 65535 again.

You can check whether the installation of the encoder is normal by viewing U0-37.

Code	Parameter Name	Display Range
U0-38	Target voltage of V/F separation	0 V ~ rated motor voltage
U0-39	Output voltage of V/F separation	0 V ~ rated motor voltage

They display the target output voltage and present actual output voltage in the V/F separation state. For V/F separation more details, see the descriptions of group d2.

Code	Parameter Name	Display Range
U0-40	DI input state visual display	-

It displays the DI state visually and the display format is shown in the following figure.

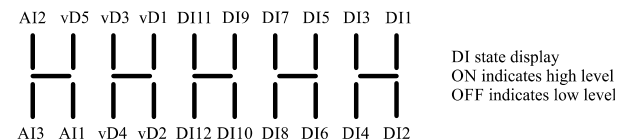

Diagram 5-34 Display format of the DI state

Code	Parameter Name	Display Range
U0-41	DO output state visual display	-

It displays the DO state visually and the display format is shown in the following figure.

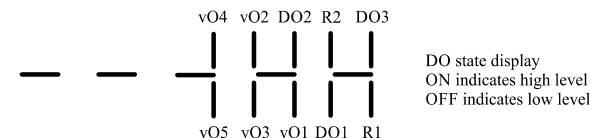

Diagram 5-35 Display format of the DO state

Code	Parameter Name	Display Range
U0-42	DI function state visual display	-

It displays whether the DI functions 1-40 are valid. The operation panel has five 7-segment LEDs and each 7-segment LED displays the selection of eight functions. The 7-segment LED is defined in the following figure.

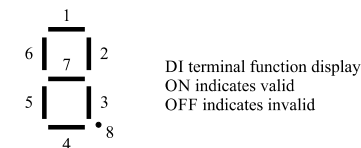

Diagram 5-36 Definition of 7-segment LED

The 7-segment LED display functions 1-8, 9-16, 17-24, 25-32 and 33-40 respectively from right to left.

Code	Parameter Name	Display Range
U0-43	DO function state visual display	-

It displays whether the DO functions 41~59 are valid. The display format is similar to U0-42.

The 7-segment LEDs display functions 41~48, 49~56 and 57~59, respectively from right to left.

Code	Parameter Name	Display Range
U0-45	Phase Z signal counting	-

It displays the phase Z counting of the present ABZ or UVW encoder. The value increases or decreases by 1 every time the encoder rotates a round forwardly or reversely. You can check whether the installation of the encoder is normal by viewing U0-45.

Code	Parameter Name	Display Range
U0-46	Present setting frequency (%)	-100.00%~100.00%
U0-47	Present running frequency (%)	-100.00%~100.00%

It displays the present setting frequency and running frequency. 100.00% corresponds to the frequency inverter's maximum frequency (b0-13).

Code	Parameter Name	Display Range
U0-48	Frequency inverter running state	0~65535

It displays the running state of the frequency inverter. The data format is listed in the following table:

U0-48	Bit0 Bit1	0: stop 1: forwarder running 2: reverse running
	Bit 2 Bit3	0: constant speed 1: acceleration 2: deceleration
	Bit 4	0: Normal DC bus voltage 1: Low DC bus voltage

Code	Parameter Name	Display Range
U0-49	Sent value of point-point communication	-100.00%~100.00%
U0-50	Received value of point-point communication	-100.00%~100.00%

It displays the data at point-point communication. U0-49 is the data sent by the master, and U0-50 is the data received by the slave.

5.24 Group A0: System parameters

Code	Parameter Name	Setting Range	Default
A0-00	User password	0~65535	0

If it is set to any non-zero number, the password protection function is enabled. After a password has been set and taken effect, you must enter the correct password in order to enter the menu. If the entered password is incorrect you cannot view or modify parameters.

If A0-00 is set to 00000, the previously set user password is cleared, and the password protection function is disabled.

Code	Parameter Name	Setting Range	Default
A0-01	Product number	Frequency inverter product number	Model dependent
A0-02	Software version	Software version of control board	Model dependent
A0-07	Parameter modification property	0: Modifiable 1: Not modifiable	0

It is used to set whether the parameters are modifiable to avoid mal-function. If it is set to 0, all parameters are modifiable. If it is set to 1, all parameters can only be viewed.

Code	Parameter Name	Setting Range	Default
A0-08	Individualized parameter display property	Unit's digit: User-defined parameter QUICK display selection. 0: Not display 1: Display Ten's digit: User-changed parameter QUICK display selection. 0: Not display 1: Display	0

The setting of parameter display mode aims to facilitate you to view different types of parameters based on actual requirements.

If one digit of A0-08 is set to 1, you can switch over to different parameter display modes by pressing key "QUICK". By default, only the "frequency inverter parameter" display mode is used.

The display codes of different parameter types are shown in the following table.

Table 6-10 Display codes of different parameter types

Parameter Type	Display Code
Frequency inverter parameter display	-dFLt
User-defined parameter display	-user
User-changed parameter display	-cHGd

The EM11 provides display of two types of individualized parameters: user-defined parameters and user-modified parameters.

User-defined parameters are included in group "A1". You can add a maximum of 32 parameters, convenient for commissioning.

In user-defined parameter mode, symbol "u" is added before the function code. For example, b0-00 is displayed as ub0-00.

In "User-changed parameter" mode, symbol "c" is added before the function code. For example, b0-00 is displayed as cb0-00.

The User-changed parameters are grouped together in QUICK menu, which is convenient for on-site troubleshooting.

Code	Parameter Name	Setting Range	Default
A0-09	Restore default settings	0: No operation 1: Restore default settings except motor parameters and accumulation record. 2: Restore default settings for all parameters 3: Reserve 4: Clear records Other: Reserve	0

0:No operation**1: Restore default settings except motor parameters**

If A0-09 is set to 1, most function codes are restored to the default settings **except** motor parameters, frequency command resolution (b0-11), fault records, accumulative running time (b9-09), accumulative power-on time (b9-08) and accumulative power consumption (b9-10).

2: Restore default settings for all parameters, including motor parameters**3: Restore user backup parameters**

If A0-09 is set to 3, the previous backup user parameters are restored (backup by setting A0-09=999).

4: Clear records

If A0-09 is set to 4, the fault records, accumulative power-on time (b9-08), accumulative running time (b9-09), and accumulative power consumption (b9-10) are cleared.

999: Back up present user parameters

If A0-09 is set to 999, the present parameter settings are backed up, helping you to restore the setting if incorrect parameter setting is performed.

5.25 Group A1: User-Defined Function Codes

Code	Parameter Name	Setting Range	Default
A1-00	User-defined function code 0	User visible function codes	ub0.01
A1-01	User-defined function code 1	User visible function codes	ub0.02
A1-02	User-defined function code 2	User visible function codes	ub0.03
A1-03	User-defined function code 3	User visible function codes	ub0.07
A1-04	User-defined function code 4	User visible function codes	ub0.12
A1-05	User-defined function code 5	User visible function codes	ub0.21
A1-06	User-defined function code 6	User visible function codes	ub0.22
A1-07	User-defined function code 7	User visible function codes	ub3.00
A1-08	User-defined function code 8	User visible function codes	ub3.01
A1-09	User-defined function code 9	User visible function codes	ub3.02
A1-10	User-defined function code 10	User visible function codes	ub4.04
A1-11	User-defined function code 11	User visible function codes	ub6.01
A1-12	User-defined function code 12	User visible function codes	ub1.00
A1-13	User-defined function code 13	User visible function codes	ub1.10
A1-14	User-defined function	User visible function codes	ud2.00

Code	Parameter Name	Setting Range	Default
	code 14		
A1-15	User-defined function code 15	User visible function codes	ud2.01
A1-16	User-defined function code 16	User visible function codes	uA0.00
A1-17	User-defined function code 17	User visible function codes	uA0.00
A1-18	User-defined function code 18	User visible function codes	uA0.00
A1-19	User-defined function code 19	User visible function codes	uA0.00
A1-20	User-defined function code 20	User visible function codes	uA0.00
A1-21	User-defined function code 21	User visible function codes	uA0.00
A1-22	User-defined function code 22	User visible function codes	uA0.00
A1-23	User-defined function code 23	User visible function codes	uA0.00
A1-24	User-defined function code 24	User visible function codes	uA0.00
A1-25	User-defined function code 25	User visible function codes	uA0.00
A1-26	User-defined function code 26	User visible function codes	uA0.00
A1-27	User-defined function code 27	User visible function codes	uA0.00
A1-28	User-defined function code 28	User visible function codes	uA0.00
A1-29	User-defined function code 29	User visible function codes	uA0.00
A1-30	User-defined function code 30	User visible function codes	uA0.00
A1-31	User-defined function code 31	User visible function codes	uA0.00

Group A1 is user-defined parameter group. You can select the required parameters from all EM11 functions codes and add them into this group, convenient for view and modification.

Group A1 provides a maximum of 32 user-defined parameters. If "A1-00" is displayed, it indicates that group A1 is null. After you enter user-defined function code mode, the displayed parameters are defined by A1-00~ A1-31 and the sequence is consistent with that in group A1.

6. EMC (Electromagnetic compatibility)

6.1 Definition

Electromagnetic compatibility is the ability of the electric equipment to run in the electromagnetic interference environment and implement its function stably without interferences on the electromagnetic environment.

6.2 EMC Standard Description

In accordance with the requirements of the national standard GB/T12668.3, the inverter needs to comply with electromagnetic interference and anti-electromagnetic interference requirements.

The existing products of our company apply the latest international standard—IEC/EN61800-3: 2004 (Adjustable speed electrical power drive systems part 3: EMC requirements and specific test methods), which is equivalent to the national standard GB/T12668.3.

IEC/EN61800-3 assesses the inverter in terms of electromagnetic interference and anti-electronic interference. Electromagnetic interference mainly tests the radiation interference, conduction interference and harmonics interference on the inverter (required for the inverter for civil use)Anti-electromagnetic interference mainly tests the conduction interference rejection, radiation interference rejection, surge interference rejection, fast and mutable pulse group interference rejection, ESD interference rejection and power low frequency end interference rejection (specific test items including: 1. Interference rejection tests of input voltage sag, interrupt and change; 2. Phase conversion interference rejection test; 3. Harmonic input interference rejection test; 4. Input frequency change test; 5. Input voltage unbalance test; 6. Input voltage fluctuation test).

The tests shall be conducted strictly in accordance with the above requirements of IEC/ EN61800-3, and the products of our company are installed and used according to Section 7.3 and have good electromagnetic compatibility in general industry environment.

6.3 EMC Guide

6.3.1 Harmonic Effect

Higher harmonics of power supply may damage the inverter. Thus, at some places where mains quality is rather poor, it is recommended to install AC input reactor.

6.3.2 Electromagnetic Interference and Installation Precautions

There are two kinds of electromagnetic interferences, one is interference of electromagnetic noise in the surrounding environment on the inverter, and the other is interference of inverter on the surrounding equipment.

Installation precautions:

- 1) The earth wires of the frequency inverter and other electric products shall be well grounded;
- 2) The power input and output power cables of the inverter and weak current signal cables (e.g. control line) shall not be arranged in parallel and vertical arrangement is preferable.
- 3) It is recommended that the output power cables of the inverter employ shield cables or steel pipe shielded cables and that the shielding layer be earthed reliably. The lead cables of the equipment suffering interferences are recommended to employ twisted-pair shielded control cables, and the

shielding layer shall be earthed reliably.

- 4) When the length of motor cable is longer than 100 meters, it needs to install output filter or reactor.

6.3.3 Handling method for the interferences of the surrounding equipment on the inverter

The electromagnetic interference on the inverter is generated because plenty of relays, contactors and electromagnetic brakes are installed near the inverter. When the inverter has error action due to the interferences, the following measures can be taken:

- 1) Install surge suppressor on the devices generating interference;
- 2) Install filter at the input end of the inverter. Refer to Section 7.3.6 for the specific operations.
- 3) The lead cables of the control signal cable of the inverter and the detection line employ shielded cable and the shielding layer shall be earthed reliably.

6.3.4 Handling method for the interferences of frequency inverter on the surrounding equipment

These interferences include two types: one is radiation interference of the inverter, and the other is conduction interference of the inverter. These two types of interferences cause the surrounding electric equipment to suffer electromagnetic or electrostatic induction. The surrounding equipment hereby produces error action. For different interferences, it can be handled by referring to the following methods:

- 1) For the measuring meters, receivers and sensors, their signals are generally weak. If they are placed nearby the inverter or together with the inverter in the same control cabinet, they are easy to suffer interference and thus generate error actions. It is recommended to handle with the following methods: Put in places far away from the interference source; do not arrange the signal cables with the power cables in parallel and never bind them together; both the signal cables and power cables employ shielded cables and are well earthed; install ferrite magnetic ring (with suppressing frequency of 30 to 1,000MHz) at the output side of the inverter and wind it 2 to 3 cycles; install EMC output filter in more severe conditions.
- 2) When the equipment suffering interferences and the inverter use the same power supply, it may cause conduction interference. If the above methods cannot remove the interference, it shall install EMC filter between the inverter and the power supply (refer to Section 7.3.6 for the prototyping operation); the surrounding equipment is separately earthed, which can avoid the interference caused by the leakage current of the inverter's earth wire when common earth mode is adopted.
- 3) The surrounding equipment is separately earthed, which can avoid the interference caused by the leakage current of the inverter's earth wire when common earth mode is adopted.

6.3.5 Leakage current and handling

There are two forms of leakage current when using the inverter. One is leakage current to the earth, and the other is leakage current between the cables.

- 1) Factors influencing the leakage current to the earth and the solutions:

There are distributed capacitance between the lead cables and the earth. The larger the distributed capacitance is, the larger the leakage current will be. The distributed capacitance can be reduced by effectively reducing the distance between the inverter and the motor. The higher the carrier frequency is, the larger the leakage current will be. The leakage current can be reduced by reducing the carrier frequency. However, reducing the carrier frequency may result in addition of motor noise. Note that additional installation of reactor is also an effective method to remove the leakage current.

The leakage current may increase following the addition of circuit current. Therefore, when the motor

power is high, the corresponding leakage current will be high too.

2) Factors of producing leakage current between the cables and solutions:

There is distributed capacitance between the output cables of the inverter. If the current passing the lines has higher harmonic, it may cause resonance and thus result in leakage current. If thermal relay is used, it may generate error action.

The solution is to reduce the carrier frequency or install output reactor. It is recommended that thermal relay not be installed before the motor when using the inverter, and that electronic over current protection function of the inverter be used instead.

6.3.6 Precautions for Installing EMC input filter at the input end of power supply

- 1) When using the inverter, please follow its rated values strictly. Since the filter belongs to Classification I electric appliances, the metal enclosure of the filter shall be large and the metal ground of the installing cabinet shall be well earthed and have good conduction continuity. Otherwise there may be danger of electric shock and the EMC effect may be greatly affected.
- 2) Through the EMC test, it is found that the filter ground must be connected with the PE end of the inverter at the same public earth. Otherwise the EMC effect may be greatly affected.
- 3) The filter shall be installed at a place close to the input end of the power supply as much as possible.

7. Fault Diagnosis and Solution

7.1 Fault Alarm and Countermeasures

EM11 inverter has 35 types of warning information and protection function. In case of abnormal fault, the protection function will be invoked, the inverter will stop output, and the faulty relay contact of the inverter will start, and the fault code will be displayed on the display panel of the inverter. Before consulting the service department, the user can perform self-check according to the prompts of this chapter, analyze the fault cause and find out t solution. If the fault is caused by the reasons as described in the dotted frame, please consult the agents of inverter or our company directly. Among the 35 types of warning information, Err22 is hardware over current or over voltage signal. In most cases, the hardware over voltage fault will cause Err22 alarm.

Table 7-1 Common faults and solution of the frequency inverter

Fault Name	Display	Possible Causes	Solutions
Inverter unit protection	Err01	1: The output circuit is grounded or short circuited. 2: The connecting cable of the motor is too long. 3: The IGBT overheat. 4: The internal connections become loose. 5: The main control board is faulty. 6: The drive board is faulty. 7: The inverter IGBT is faulty.	1: Eliminate external faults. 2: Install a reactor or an output filter. 3: Check the air filter and the cooling fan. 4: Connect all cables properly. 5: Ask for technical support 6: Ask for technical support 7: Ask for technical support
Over current during acceleration	Err02	1: The output circuit is grounded or short circuited. 2: Motor auto-tuning is not performed. 3: The acceleration time is too short. 4: Manual torque boost or V/F curve is not appropriate. 5: The voltage is too low. 6: The startup operation is performed on the rotating motor. 7: A sudden load is added during acceleration. 8: The frequency inverter model is of too small power class.	1: Eliminate external faults. 2: Perform the motor auto-tuning. 3: Increase the acceleration time. 4: Adjust the manual torque boost or V/F curve. 5: Adjust the voltage to normal range. 6: Select rotational speed tracking restart or start the motor after it stops. 7: Remove the added load. 8: Select a frequency inverter of higher power class.
Over current during deceleration	Err03	1: The output circuit is grounded or short circuited. 2: Motor auto-tuning is not performed. 3: The deceleration time is too short. 4: The voltage is too low. 5: A sudden load is added during deceleration. 6: The braking unit and braking resistor are not installed.	1: Eliminate external faults. 2: Perform the motor auto-tuning. 3: Increase the deceleration time. 4: Adjust the voltage to normal range. 5: Remove the added load. 6: Install the braking unit and braking resistor.

Fault Name	Display	Possible Causes	Solutions
Over current at constant speed	Err04	1: The output circuit is grounded or short circuited. 2: Motor auto-tuning is not performed. 3: The voltage is too low. 4: A sudden load is added during operation. 5: The frequency inverter model is of too small power class.	1: Eliminate external faults. 2: Perform the motor auto-tuning. 3: Adjust the voltage to normal range. 4: Remove the added load. 5: Select an Frequency inverter of higher power class.
Overvoltage during acceleration	Err05	1: The input voltage is too high. 2: An external force drives the motor during acceleration. 3: The acceleration time is too short. 4: The braking unit and braking resistor are not installed.	1: Adjust the voltage to normal range. 2: Cancel the external force or install a braking resistor. 3: Increase the acceleration time. 4: Install the braking unit and braking resistor.
Overvoltage during deceleration	Err06	1: The input voltage is too high. 2: An external force drives the motor during deceleration. 3: The deceleration time is too short. 4: The braking unit and braking resistor are not installed.	1: Adjust the voltage to normal range. 2: Cancel the external force or install the braking resistor. 3: Increase the deceleration time. 4: Install the braking unit and braking resistor.
Overvoltage at constant speed	Err07	1: The input voltage is too high. 2: An external force drives the motor during deceleration.	1: Adjust the voltage to normal range. 2: Cancel the external force or install the braking resistor.
Control power supply fault	Err08	The input voltage is not within the allowable range.	Adjust the input voltage to the allowable range.
Low voltage	Err09	1: Instantaneous power failure occurs on the input power supply. 2: The frequency inverter's input voltage is not within the allowable range. 3: The DC bus voltage is abnormal. 4: The rectifier bridge and buffer resistor are faulty. 5: The drive board is faulty. 6: The main control board is faulty.	1: Reset the fault. 2: Adjust the voltage to normal range. 3: Ask for technical support 4: Ask for technical support 5: Ask for technical support 6: Ask for technical support
Frequency inverter overload	Err10	1: The load is too heavy or locked- rotor occurs on the motor. 2: The frequency inverter model is of too small power class.	1: Reduce the load and check the motor and mechanical condition. 2: Select a frequency inverter of higher power class.
Motor overload	Err11	1: bb-01 is set improperly. 2: The load is too heavy or locked- rotor occurs on the motor. 3: The frequency inverter model is of too small power class.	1: Set bb-01 correctly. 2: Reduce the load and check the motor and the mechanical condition. 3: Select a frequency inverter of higher power class.

Fault Name	Display	Possible Causes	Solutions
Power input phase loss	Err12	1: The three-phase power input is abnormal. 2: The drive board is faulty. 3: The lightningproof board is faulty. 4: The main control board is faulty.	1: Eliminate external faults. 2: Ask for technical support. 3: Ask for technical support. 4: Ask for technical support.
Power output phase loss	Err13	1: The cable connecting the frequency inverter and the motor is faulty. 2: The frequency inverter's three-phase outputs are unbalanced when the motor is running. 3: The drive board is faulty. 4: The IGBT module is faulty.	1: Eliminate external faults. 2: Check whether the motor three phase winding is normal. 3: Ask for technical support. 4: Ask for technical support.
IGBT Module overheat	Err14	1: The ambient temperature is too high. 2: The air filter is blocked. 3: The fan is damaged. 4: The thermally sensitive resistor of the IGBT module is damaged. 5: The inverter IGBT module is damaged.	1: Lower the ambient temperature. 2: Clean the air filter. 3: Replace the damaged fan. 4: Replace the damaged thermally sensitive resistor. 5: Replace the inverter module.
External equipment fault	Err15	1: External fault signal is input via DI. 2: External fault signal is input via virtual I/O.	1: Reset the operation. 2: Reset the operation.
Communication fault	Err16	1: The host computer is in abnormal state. 2: The communication cable is faulty. 3: The communication extension card is set improperly. 4: The communication parameters in group bA are set improperly.	1: Check the cabling of host computer. 2: Check the communication cabling. 3: Set the communication extension card correctly. 4: Set the communication parameters properly.
Contactors fault	Err17	1: The drive board and power supply are faulty. 2: The contactor is faulty.	1: Replace the faulty drive board or power supply board. 2: Replace the faulty contactor.
Current detection fault	Err18	1: The HALL device is faulty. 2: The drive board is faulty.	1: Replace the faulty HALL device. 2: Replace the faulty drive board.
Motor auto-tuning fault	Err19	1: The motor parameters are not set according to the nameplate. 2: The motor auto-tuning times out.	1: Set the motor parameters according to the nameplate properly. 2: Check the cable connecting the Frequency inverter and the motor.
Encoder fault	Err20	1: The encoder type is incorrect. 2: The cable connection of the encoder is incorrect. 3: The encoder is damaged. 4: The PG card is faulty.	1: Set the encoder type correctly based on the actual situation. 2: Eliminate external faults. 3: Replace the damaged encoder. 4: Replace the faulty PG card.
EEPROM read- write fault	Err21	The EEPROM chip is damaged.	Replace the main control board.

Fault Name	Display	Possible Causes	Solutions
Frequency inverter hardware fault	Err22	1: Overvoltage exists. 2: Over current exists.	1: Handle based on over voltage. 2: Handle based on over current.
Short circuit to ground	Err23	The motor is short circuited to the ground.	Replace the cable or motor.
Accumulative running time reached	Err26	The accumulative running time reaches the setting value.	Clear the record through parameter A0-09
User-defined fault 1	Err27	1: The signal of user-defined fault 1 is input via DI. 2: The signal of user-defined fault 1 is input via virtual I/O.	1: Reset the operation. 2: Reset the operation.
User-defined fault 2	Err28	1: The signal of user-defined fault 2 is input via DI. 2: The signal of user-defined fault 2 is input via virtual I/O.	1: Reset the operation. 2: Reset the operation.
Accumulative power-on time reached	Err29	The accumulative power-on time reaches the setting value.	Clear the record through parameter A0-09
Off load	Err30	The frequency inverter running current is lower than the setting value.	Check that the load is disconnected or the parameter setting is correct.
PID feedback lost during running	Err31	The PID feedback is lower than the setting of C0-26.	Check the PID feedback signal or set C0-26 to a proper value.
By wave current limiting fault	Err40	1: The load is too heavy or locked- rotor occurs on the motor. 2: The frequency inverter model is of too small power class.	1: Reduce the load and check the motor and mechanical condition. 2: Select a frequency inverter of higher power class.
Motor switchover fault during running	Err41	Change the selection of the motor via terminal during running of the frequency inverter.	Perform motor switchover after the frequency inverter stops.
Too large speed deviation	Err42	1: The encoder parameters are set incorrectly. 2: The motor auto-tuning is not performed. 3: The detection parameters of too large speed deviation are set incorrectly.	1: Set the encoder parameters properly. 2: Perform the motor auto-tuning. 3: Set the detection parameters correctly based on the actual situation.
Motor over-speed	Err43	1: The encoder parameters are set incorrectly. 2: The motor auto-tuning is not performed. 3: The over-speed detection parameters are set incorrectly.	1: Set the encoder parameters properly. 2: Perform the motor auto-tuning. 3: Set the over-speed detection parameters correctly based on the actual situation.

Fault Name	Display	Possible Causes	Solutions
Motor overheat	Err45	1: The cabling of the temperature sensor becomes loose. 2: The motor temperature is too high.	1: Check the temperature sensor cabling and eliminate the cabling fault. 2: Lower the carrier frequency or adopt other heat radiation measures.
Initial position fault	Err51	1: The motor parameters are not too deviation based on the actual situation.	1: Check that the motor parameters are set correctly and whether the setting of rated current is too small.

7.2 Common Faults and Solutions

You may come across the following faults during the use of the frequency inverter. Refer to the following table for simple fault analysis.

Table 8-2 Troubleshooting to common faults of the frequency inverter

SN	Fault	Possible Causes	Solutions
1	There is no display at power-on.	1: There is no power supply to the frequency inverter or the power input to the frequency inverter is too low. 2: The power supply of the switch on the drive board of the frequency inverter is faulty. 3: The rectifier bridge is damaged. 4: The control board or the operation panel is faulty. 5: The cable connecting the control board and the drive board and the operation panel loose or breaks.	1: Check the power supply. 2: Check the DC bus voltage. 3: Check the internal wiring plug 4: Change a keypad 5: Ask for technical support.
2	“-coc-” is displayed at power-on.	1: The cable between the drive board and the control board is in poor contact. 2: Related components on the control board are damaged. 3: The motor or the motor cable is short circuited to the ground. 4: The HALL device is faulty. 5: The power input to the frequency inverter is too low.	1: Checking wiring 2: Ask for technical support.
3	“Err23” is displayed at power-on.	1: The motor or the motor output cable is short-circuited to the ground. 2: The frequency inverter is damaged.	1: Measure the insulation of the motor and the output cable with a megger. 2: Ask for technical support.
4	The frequency inverter display is normal after power-on. But “coc-” is displayed after running and stops immediately.	1: The cooling fan is damaged or locked-rotor occurs. 2: The external control terminal cable is short circuited.	1: Replace the damaged fan. 2: Eliminate external fault.

SN	Fault	Possible Causes	Solutions
5	Err14 (IGBT module overheat) fault is reported frequently.	1: The setting of carrier frequency is too high. 2: The cooling fan is damaged, or the air filter is blocked. 3: Components inside the frequency inverter are damaged (thermal coupler or others).	1: Reduce the carrier frequency (d6-00). 2: Replace the fan and clean the air filter. 3: Ask for technical support.
6	The motor does not rotate after the frequency inverter runs.	1: Check the motor and the motor cables. 2: The frequency inverter parameters are set improperly (motor parameters). 3: The cable between the drive board and the control board is in poor contact. 4: The drive board is faulty.	1: Ensure the cable between the Frequency inverter and the motor is normal. 2: Replace the motor or clear mechanical faults. 3: Check and re-set motor parameters.
7	The DI terminals are disabled.	1: The parameters are set incorrectly. 2: The external signal is incorrect. 3: The jumper bar across OP and+24 V becomes loose. 4: The control board is faulty.	1: Check and reset the parameters in group F4. 2: Re-connect the external signal cables. 3: Re-confirm the jumper bar across OP and +24 V. 4: Ask for technical support.
8	The motor speed is always low in VC mode.	1: The encoder is faulty. 2: The encoder cable is connected incorrectly or in poor contact. 3: The PG card is faulty. 4: The drive board is faulty.	1: Replace the encoder and ensure the cabling is proper. 2: Replace the PG card. 3: Ask for technical support.
9	The frequency inverter reports over current and overvoltage frequently.	1: The motor parameters are set improperly. 2: The acceleration/deceleration time is improper. 3: The load fluctuates.	1: Re-set motor parameters or re-perform the motor auto-tuning. 2: Set proper acceleration/ deceleration time. 3: Ask for technical support.
10	Err17 is reported of power-on or running.	The soft startup contactor is not sucked up.	1: Check whether the contactor cable is loose. 2: Check whether the contactor is faulty. 3: Check whether 24 V power supply of the contactor is faulty. 4: Ask for technical support.
11	Err18 is displayed of power-on.	Related component on the control board is damaged.	Replace the control board.

Appendix I. Modbus communication protocol

EM11series of inverter provides RS485 communication interface, and adopts MODBUS communication protocol. User can carry out centralized monitoring through PC/PLC to get operating requirements. And user can set the running command, modify or read the function codes, the working state or fault information of frequency inverter by Modbus communication protocol.

I. About Protocol

This serial communication protocol defines the transmission information and use format in the series communication and it includes master-polling (or broadcasting) format, master coding method and the content includes function code of action, transferring data and error checking. The response of slave is the same structure, and it includes action confirmation, returning the data and error checking etc. If slave takes place the error while it is receiving the information or cannot finish the action demanded by master, it will send one fault signal to master as a response.

II. Application Methods

The frequency inverter will be connected into a "Single-master Multi-slave" PC/PLC control net with RS485 bus as the communication slave.

III. Bus structure

1) Hardware interface.

The "485+" and "485-" terminals on frequency inverter are the communication interfaces of Modbus

2) Topological mode

It is a "Single-master Multi-slave" system. In this network, every communication machine has a unique slave address. One of them is as "master" (usually PC host machine, PLC and HMI, etc.), actively sends out the communication, to read or write the parameters of slave. Other machines will be used as slave and response to the inquiry/command from master. At one time only one machine can send the data and other machines are in the receiving status. The setup range of slave address is 0 to 247. Zero refers to broadcast communication address. The address of slave must be exclusive in the network.

3) Transmission mode

There provide asynchronous series and half-duplex transmission mode. In the series asynchronous communication, the data is sent out frame by frame in the form of message. According to the Modbus-RTU protocol, when the free time of no transmission in communication data lines is more than the transmission time of 3.5byte, it indicates that a new start of communication frame.

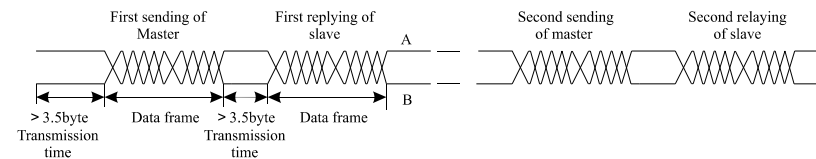

EM11 series inverter has built-in the Modbus-RTU communication protocol, and is applicable to response the slave "Inquiry/command" or doing the action according to the master's "Inquiry / Command" and

response to the data.

Here, master is personnel computer (PC), industrial machine or programmable logical controller (PLC), and the slave is inverter. Master not only visits some slave, but also sends the broadcast information to all the slaves. For the single master "Inquiry/Command", all of slaves will return a signal that is a response; for the broadcast information provided by master, slave needs not feedback a response to master machine.

Communication data structure

Modbus protocol communication data format of EM11 series inverter is shown as following. The inverter only support the reading and writing of Word type parameters, the corresponding reading operation command is "0x03", the writing operation command is "0x06". The writing and reading operation of byte or bit is not supported.

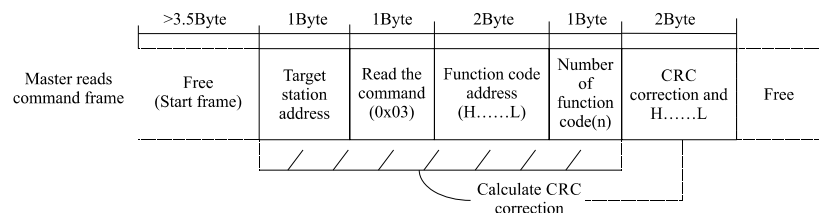

In theory, the host computer can continuously read several function codes once (that is, the maximum value of "n" is 12), but note that not to jump across the last function code in this function group to avoid the wrong reply.

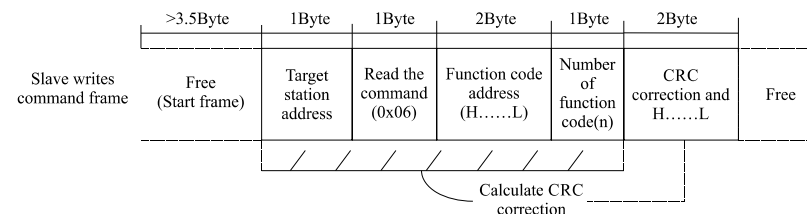
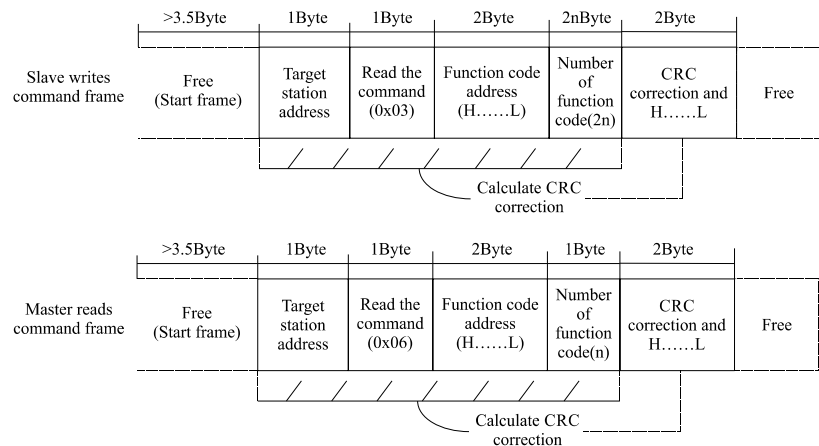

If the wrong communication frame was detected by the slave or other reasons caused the failure of reading and writing, the wrong frame will be replied.

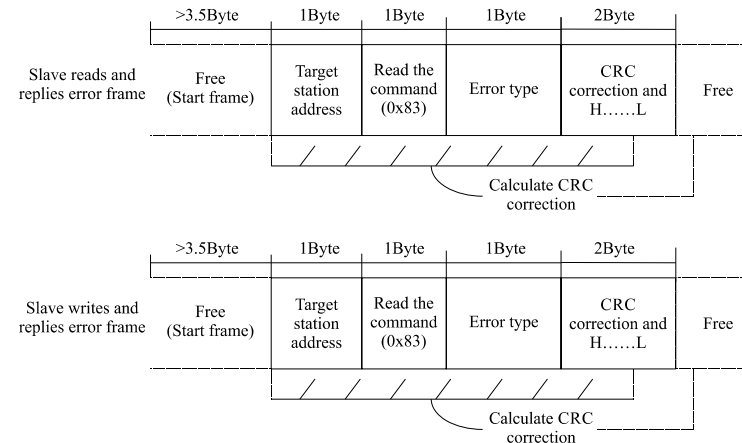

- Error types :
- 01-Command code error
 - 02-Address error
 - 03-Data error
 - 04-Command cannot to process

RTU frame format

Frame start (START)	More than the 3.5- character time
Slave address(ADR)	Communication address:1 to 247(0: broadcast address)
Command code(CMD)	03: Read slave parameters 06: Write slave parameters
Function code address(H)	It indicates the external parameter address of frequency inverter in hexadecimal format; There are functional code or non-functional code (such as running state parameter/ running command parameters) type parameters, for details see the address definition.
Function code address(L)	During the transmission, high bit is put in the front, and low bit is at the back.
Number of function code(H)	It indicates the number of function code ready by the frame. If it is "1", then it indicates that it reads one function code. During the transmission, high bit is put in the front, and low bit is at the back.
Number of function code(L)	Only one function code can be modified at one time without the field.

Data(H)	It indicates the replying data or the data waiting to write-in. During the transmission, high bit is put in the front, and low bit is at the back.
Data(L)	
END	3.5- character time

CRC Checking

In RTU mode, messages include an error-checking field that is based on a CRC method. The CRC field checks the contents of the entire message. The CRC field is two bytes, containing a 16-bit binary value. The CRC value is calculated by the transmitting device, which appends the CRC to the message. The receiving device recalculates a CRC during receipt of the message, and compares the calculated value to the actual value it received in the CRC field.

If the two values are not equal, that means transmission is error

The CRC is started by 0xFFFF. Then a process begins of applying successive eight-bit bytes of the message to the current contents of the register. Only the eight bits of data in each character are used for generating the CRC. Start and stop bits, and the parity bit, do not apply to the CRC. During generation of the CRC, each eight-bit character is exclusive ORed with the register contents. Then the result is shifted in the direction of the least significant bit (LSB), with a zero filled into the most significant bit (MSB) position. The LSB is extracted and examined. If the LSB was a 1, the register is then exclusive ORed with a preset, fixed value. If the LSB was a 0, no exclusive OR takes place. This process is repeated until eight shifts have been performed. After the last (eighth) shift, the next eight-bit byte is exclusive ORed with the register's current value, and the process repeats for eight more shifts as described above. The final contents of the register, after all the bytes of the message have been applied, is the CRC value.

When the CRC is appended to the message, the low-order byte is appended first, followed by the high-order byte.

```
unsigned int crc_chk_value(unsigned char *data_value, unsigned char length
```

```
{
    unsigned int crc_value=0xFFFF;
    int i;
    while(length-->0)
    {
        crc_value^=*data_value++;
        for(i=0;i<8;i++)
        {
            if(crc_value&0x0001)
            {
                crc_value=(crc_value>>1)^0xa001;
            }
            else
            {
                crc_value=crc_value>>1;
            }
        }
    }
    return(crc_value);
}
```

Definition of communication parameter address

Read and write function-code parameters (Some functional code is not changed, only for the manufacturer use.)

The group number and mark of function code is the parameter address for indicating the rules.

High level bytes: Group A0~AF(GroupA0-A2/ Groupb0-bC), Groupb0-bF(Group C0-C6/Groupd0-d6), 70-7F(Group U)

Low level bytes: 00 to FF

For example: b0-03, address indicates to 0xA303.

Note: Group U: Only for reading parameter, cannot be changed parameters, some parameters cannot be changed during operation, some parameters regardless of what kind of state the inverter in, the parameters cannot be changed. Change the function code parameters, pay attention to the scope of the parameters, units, and relative instructions.

Function code group	Communication inquiry address	Inquiry address When Communication modifies RAM
A0~ A2	0xA000~ 0xA2FF	0x4000~ 0x42FF
b0~bC	0xA300~ 0xAFFF	0x4300~ 0x4FFF
C0~C6	0xb000~ 0xB7FF	0x5000~ 0x57FF
d0~d6	0xB800~ 0xBEFF	0x5800~ 0x5EFF
U0	0x7000~ 0x70FF	

Besides, due to EEPROM be frequently stored, it will reduce the lifetime of EEPROM. In the communication mode, and some function codes don't have to be stored as long as change the RAM value.

Stop/start parameter

Parameter address	Parameter description	Parameter address	Parameter description
1000	Communication set value(-10000 ~ 10000)(Decimal)	1010	PID setting
1001	Running frequency	1011	PID feedback
1002	DC Bus voltage	1012	PLC process
1003	Output voltage	1013	Pulse input frequency, unit: 0.01KHz
1004	Output current	1014	Feedback speed, unit:0.1Hz
1005	Output power	1015	Remaining running time
1006	Output torque	1016	Voltage before AI1 correction
1007	Running speed	1017	Voltage before AI2 correction
1008	DI input terminal	1018	Voltage before AI3 correction
1009	DO output terminal	1019	Linear speed
100A	AI1 voltage	101A	Present power-on time
100B	AI2 voltage	101B	Present running time
100C	AI3 voltage	101C	Pulse input frequency, unit:1Hz
100D	Counting value input	101D	Communication setting value
100E	Length value input	101E	Actual feedback speed
100F	Load speed	101F	Main frequency X display
		1020	Auxiliary frequency Y display

Note: Communication setting value is the percentage of relative value, 10000 corresponds to 100%, -10000 correspond to -100.00%.

Control command input frequency inverter: (write in only)

Command word address	Command function
2000	0001: Forward running
	0002: Reverse running
	0003: Forward jog
	0004: Reverse jog
	0005: Free stop
	0006:Decelerating stop
	0007: Fault reset

Read inverter status: (read only)

Command word address	Command function
3000	0001: Forward running
	0002: Reverse running
	0003: Stop

Parameter locking password collation: (If the feedback is the 8888H, it indicates the password collation passed)

Password address	Contents of input password
1F00	*****

Digital output terminal control: (write in only)

Address Of locking password command	Contents of locking password command
2001	BIT0: DO1 output control BIT1: DO2 output control BIT2: Relay 1 output control BIT3: Relay 2 output control BIT4: FMR output control BIT5: VDO1 BIT6: VDO2 BIT7: VDO3 BIT8: VDO4 BIT9: VDO5

Analog output AO1 control: (write in only)

Command word address	Command function
2002	0~7FFF indicates 0%~100%

Analog output AO2 control: (write in only)

Command word address	Command function
2003	0~7FFF indicates 0%~100%

Pulse output control: (write in only)

Command word address	Command function
2004	0~7FFF indicates 0%~100%

Inverter fault description:

Inverter fault description	Inverter fault information	
8000	0000: No fault	0015: EEPROM read-write in fault
	0001: Reserved	0016: Frequency inverter hardware fault
	0002: acceleration over current	0017: Short circuit to ground fault
	0003: deceleration over current	0018: Reversed
	0004: Constant speed over current	0019: Reversed
	0005: acceleration over voltage	001A: Accumulative running time reached
	0006: deceleration over voltage	001B: User-defined fault 1
	0007:Constant speed over voltage	001C: User-defined fault 2
	0008: Buffer resistor fault	001D: Accumulative power-on time reached
	0009: less voltage fault	001E: Off load
	000A:Frequency inverter overload	001F: PID lost during running
	000B: Motor overload	0028: fast current limit fault
	000C: Input phase failure	0029: Motor switchover fault during running
	000D: Output phase failure	002A: Too large speed deviation
	000E: IGBT overheat	002B: Motor over-speed
	000F: External equipment fault	002D: Motor overheat
0010: Communication fault	005A: Encode lines setting fault	
0011: Contactor fault	005B: Not connect to the encoder	
0012: Current detection fault	005C: Initial location fault	
0013: Motor auto-tuning fault	005E: Speed feedback fault	
0014: Encoder/PG fault		

Group bA Communication parameters

Code	Parameter Name	Setting Range	Default
bA-00	Communication type selection	0: Modbus protocol	0

The EM11 now supports Modbus, later will add the communication protocol such as PROFIBUS-DP and CANOpen protocol. For details, see the description of "EM11 communication protocol".

Code	Parameter Name	Setting Range	Default
bA-01	Baud ratio setting	Unit's digit: Modbus baud ratio. 0: 300 BPS 1: 600 BPS 2: 1200 BPS 3: 2400 BPS 4: 4800 BPS 5: 9600 BPS 6: 19200 BPS 7: 38400 BPS	5

This parameter is used to set the data transfer rate from host computer and the frequency inverter. Please note that baud ratio of the host computer and the inverter should be consistent. Otherwise, the communication is impossible. The higher the baud ratio is, the faster the communication is.

Code	Parameter Name	Setting Range	Default
bA-02	Modbus Data format	0: No check, data format <8,N,2> 1: Even parity check, data format<8,E,1> 2: Odd Parity check, data format<8,O,1> 3: No check, data format <8,N,1> Valid for Modbus	0

The host computer and frequency inverter setup data format must be consistent, otherwise, communication is impossible.

Code	Parameter Name	Setting Range	Default
bA-03	Broadcast address	0~247 (0: Broadcast address) 0 is broadcast address	1

When the local address is set to 0, that is, broadcast address, it can realize the broadcast function of host computer.

Code	Parameter Name	Setting Range	Default
bA-04	Modbus response time	0~20 ms Only valid for Modbus	2 ms

Response delay time: it refers to the interval time from the inverter finishes receiving data to sending data to the host machine. If the response time is less than the system processing time, then the response delay time is based on the time delay of the system processing time. If the response delay time is more than the system processing time, after the system processes the data, it should be delayed to wait until the response delay time is reached, then sending data back to host machine.

Code	Parameter Name	Setting Range	Default
bA-05	Communication timeout	0.0s:invalid 0.1s~60.0s Valid for Modbus	0.0s

When the function is set to 0.0s, the communication interface timeout parameter is invalid.

When the function code is set to time value, if the interval time between the communication and the next communication is beyond the communication timeout, the system will report communication failure error (Err16). At normal circumstances, it will be set as invalid. If in the continuous communication system, set this parameter, you can monitor the communication status.

Code	Parameter Name	Setting Range	Default
bA-06	Modbus protocol data transmission format selection	Unit's digit: Modbus protocol. 0: Non-standard Modbus protocol 1: Standard Modbus protocol	1

bA-06=1: Select standard Modbus protocol.

bA-06=0: When reading the command, the slave machine return is one byte more than the standard Modbus protocol's, for details, refer to communication data structure of this protocol.

Code	Parameter Name	Setting Range	Default
bA-07	Communication reading current resolution	0: 0.01A 1: 0.1A	0

It is used to confirm the unit of current value when the communication reads the output current.

Appendix II. Function Code Table

If A0-00 is set to a non-zero number, parameter protection is enabled. You must write in correct user password to enter the menu.

To cancel the password protection function, enter with password and set A0-00 to 0.

The user defined fast menu can directly enter without password.

Group "A" is frequency inverter system parameter. Group "b" is basic function parameters. Group "C" is application parameter, Group "d" is control parameter, and Group "U" is monitoring function parameters.

The symbols in the function code table are described as follows:

" ": The parameter can be modified when the frequency inverter is in stop or running state.

"-": The parameter cannot be modified when the frequency inverter is in running state.

"●": The parameter is the actually measured value and cannot be modified.

"*": The parameter is factory parameter and can be modified only by the manufacturer.

Standard Function Parameters

Code	Parameter Name	Setting range	Default	Property
Group b0: Basic Function Parameters				
b0-00	Motor type selection	Unit's digit: Motor 1 selection Ten's digit: Motor 2 selection 0: AC asynchronous motor 1: Permanent magnetic synchronous motor	00	
b0-01	Motor control mode	Unit's digit: Motor 1 control mode selection. Ten's digit: Motor 2 control mode selection. 0: Sensor-less vector control (SVC) 1: Closed-loop vector control (VC) 2: V/F control Hundred's digit/Thousand's digit: reserved Ten thousand's digit: Motor selection 0: Motor 1 1: Motor 2	00000	
b0-02	Command source selection	0: Keypad control (LED off) 1: Terminal control (LED on) 2: Communication control (LED blinking)	0	
b0-03	Main frequency source X selection	0: Digital setting (Preset frequency b0-12, UP/DOWN modifiable, no-record after power off) 1: Digital setting (Preset frequency b0-12, UP/DOWN modifiable, record after power off) 2: AI1 3: AI2 4: AI3 5: Pulse setting (DI6) 6: Multi-function 7: Built-in PLC 8: PID 9: Communication setting	0	

Code	Parameter Name	Setting range	Default	Property
b0-04	Auxiliary frequency source Y selection	The same as b0-03 (Main frequency source X selection)	1	
b0-05	Selection of auxiliary frequency Y range	0: Relative to maximum frequency 1: Relative to main frequency X	0	
b0-06	Range of auxiliary frequency Y	0%~150%	100%	
b0-07	Frequency source selection	Unit's digit: Frequency source selection. 0: Main frequency source X 1: X and Y calculation (calculation result determined by ten's digit) 2: Switchover between X and Y 3: Switchover between X and "X and Y calculation" 4: Switchover between Y and "X and Y calculation" Ten's digit: X and Y calculation relationship 0: X+Y 1: X-Y 2: Maximum of them 3: Minimum of them	0	
b0-08	Frequency offset of auxiliary frequency source of X and Y	0.00 Hz ~ maximum frequency(b0-13)	0.00 Hz	
b0-09	Binding command source to frequency source	Unit's digit: Binding keypad command to following frequency source. 0: No binding 1: Frequency source by digital setting 2: AI1 3: AI2 4: AI3 5: Pulse setting (DI6) 6: Multi-function 7: Simple PLC 8: PID 9: Communication setting Ten's digit: Binding terminal command to frequency source. 0~9, same as unit's digit Hundred's digit: Binding communication command to frequency source. 0~9, same as unit's digit Thousand's digit: Automatically running binding to frequency source. 0~9, same as unit's digit	0	
b0-10	Record of digital setting frequency of power failure	0: not record 1: record	1	

Code	Parameter Name	Setting range	Default	Property
b0-11	Frequency unit	1: 0.1 Hz 2: 0.01 Hz	2	
b0-12	Preset frequency	0.00 ~ maximum frequency (b0-13)	50.00 Hz	
b0-13	Maximum frequency	50.00~3000.00 Hz	50.00 Hz	
b0-14	Source of frequency upper limit	0: Set by (b0-15) 1: AI1 2: AI2 3: AI3 4: Pulse setting (DI6) 5: Communication setting	0	
b0-15	Frequency upper limit	Frequency lower limit (b0-17) ~ maximum frequency (b0-13)	50.00 Hz	
b0-16	Frequency upper limit offset	0.00 Hz~ maximum frequency(b0-13)	0.00 Hz	
b0-17	Frequency lower limit	0.00 Hz ~frequency upper limit(b0-15)	0.00 Hz	
b0-18	Rotation direction	0: Forward direction 1: Reverse direction	0	
b0-19	Base frequency for UP/DOWN modification during running	0: Running frequency 1: Setting frequency	0	
b0-20	Acceleration/Deceleration mode	0: Linear acceleration/ deceleration 1: S-curve acceleration/deceleration A 2: S-curve acceleration/deceleration B	0	
b0-21	Acceleration time 1	0.00s~650.00s (b0-25 = 2) 0.0s~6500.0s (b0-25 = 1) 0s~65000s (b0-25 = 0)	Model dependent	
b0-22	Deceleration time 1	0.00s~650.00s (b0-25 = 2) 0.0s~6500.0s (b0-25 = 1) 0s~65000s (b0-25 = 0)	Model dependent	
b0-23	Time proportion of S-curve start segment	0.0% ~ (100.0% minus b0-24)	30.0%	
b0-24	Time proportion of S-curve end segment	0.0% ~ (100.0% minus b0-23)	30.0%	
b0-25	Acceleration/Deceleration time unit	0: 1s 1: 0.1s 2: 0.01s	1	
b0-26	Acceleration/Deceleration time base frequency	0: Maximum frequency (b0-13) 1: Set frequency 2: 100 Hz	0	
Group b1: Start and Stop Control Parameters				
b1-00	Start mode	0: Direct start 1: Rotational speed tracking restart 2: Pre-excited start (AC asynchronous motor)	0	
b1-01	Rotational speed tracking mode	0: From frequency at stop 1: From zero speed 2: From maximum frequency	0	

Code	Parameter Name	Setting range	Default	Property
b1-02	Rotational speed tracking speed	1~100	20	
b1-03	Startup frequency	0.00~10.00 Hz	0.00 Hz	
b1-04	Startup frequency holding time	0.0s~100.0s	0.0s	
b1-05	Startup DC braking current/ Pre-excited current	0%~100%	0%	
b1-06	Startup DC braking time/ Pre-excited time	0.0s~100.0s	0.0s	
b1-07	Stop mode	0: Decelerate to stop 1: free stop	0	
b1-08	DC braking initial frequency of stopping	0.00 Hz ~ maximum frequency	0.00 Hz	
b1-09	DC braking waiting time of stopping	0.0s~100.0s	0.0s	
b1-10	DC braking current of stopping	0%~100%	0%	
b1-11	DC braking time of stopping	0.0s~100.0s	0.0s	
Group b2: Auxiliary Function				
b2-00	JOG running frequency	0.00 Hz ~ maximum frequency	6.00 Hz	
b2-01	JOG acceleration time	0.0s~6500.0s	Model dependent	
b2-02	JOG deceleration time	0.0s~6500.0s	Model dependent	
b2-03	Acceleration time 2	0.0s~6500.0s	Model dependent	
b2-04	Deceleration time 2	0.0s~6500.0s	Model dependent	
b2-05	Acceleration time 3	0.0s~6500.0s	Model dependent	
b2-06	Deceleration time 3	0.0s~6500.0s	Model dependent	
b2-07	Acceleration time 4	0.0s~6500.0s	Model dependent	
b2-08	Deceleration time 4	0.0s~6500.0s	Model dependent	
b2-09	Jump frequency 1	0.00 Hz ~maximum frequency	0.00 Hz	
b2-10	Jump frequency 2	0.00 Hz ~ maximum frequency	0.00 Hz	
b2-11	Frequency jump amplitude	0.00 Hz ~ maximum frequency	0.00Hz	
b2-12	Jump frequency during acceleration/ deceleration	0: Disabled 1: Enabled	0.00Hz	

Code	Parameter Name	Setting range	Default	Property
b2-13	Frequency switchover point between acceleration time 1 and acceleration time 2	0.00 Hz ~ maximum frequency	0.00 Hz	
b2-14	Frequency switchover point between deceleration time 1 and deceleration time 2	0.00 ~ maximum frequency	0.00 Hz	
b2-15	Reverse running	0: Enabled 1: Disabled	0	
b2-16	Forward/Reverse rotation dead-zone time	0.0~3000.0s	0.0s	
b2-17	Running mode when set frequency lower than frequency lower limit	0: Run at frequency lower limit 1: Stop 2: Run at zero speed	0	
b2-18	Droop control	0.00Hz~10.00 Hz	0.00 Hz	
b2-19	Terminal JOG priority	0: Disabled 1: Enabled	0	
b2-20	Setting power-on time reach threshold	0~65000 h	0 h	
b2-21	Setting running time reach threshold	0~65000 h	0 h	
b2-22	Action after running time reached	0: Continue to run 1: Stop	0	
b2-23	Cooling fan control	0: Fan working during running 1: Fan working during power on	0	
b2-24	Dormant frequency	0.00Hz~wakeup frequency (b2-26)	0.00 Hz	
b2-25	Dormant delay time	0.0s~6000.0s	0.0s	
b2-26	Wakeup frequency	Dormant frequency (b2-24)~ maximum frequency (b0-13)	0.00 Hz	
b2-27	Wakeup delay time	0.0s~6000.0s	0.0s	
b2-28	Timing function	0: Disabled 1: Enabled	0	
b2-29	Timing duration source	0: b2-30 1: AI1 2: AI2 3: AI3 (100% of analog input corresponds to the value of b2-30)	0	
b2-30	Timing duration	0.0min~6500.0 min	0.0 min	
b2-31	This time running time reached threshold	0.0min~6500.0 min	0.0 min	
b2-32	Startup protection	0: No 1: Yes	0	
Group b3: Switch Input Terminal Parameters				

Code	Parameter Name	Setting range	Default	Property
b3-00	DI1 function selection	0: No function 1: Forward RUN (FWD) or running command 2: Reverse RUN (REV) or FWD/REV running direction	1	
b3-01	DI2 function selection	3: Three-line control	4	
b3-02	DI3 function selection	4: Forward JOG (FJOG)	9	
b3-03	DI4 function selection	5: Reverse JOG (RJOG)	12	
b3-04	DI5 function selection	6: Multi-function terminal 1	13	
b3-05	DI6/HDI function selection	7: Multi-function terminal 2 8: Multi-function terminal 3 9: Multi-function terminal 4	32	
b3-06	DI7 function selection(extend)	10: Terminal UP 11: Terminal DOWN 12: clear to zero of UP and DOWN setting (terminal, keypad) 13: Terminal 1 for acceleration/ deceleration time selection 14: Terminal 2 for acceleration/ deceleration time selection	0	
b3-07	DI8 function selection(extend)	15: Frequency source switchover 16: Switchover between main frequency source X and preset frequency 17: Switchover between auxiliary frequency source Y and preset frequency 18: Terminal 1 for Command source switchover 19: Terminal 2 for Command source switchover 20: Speed control/Torque control switchover 21: Torque control prohibited 22: PID pause 23: PID integral pause 24: Reverse PID action direction 25: PID parameter switchover 26: PLC status reset 27: Swing pause 28: Counter input 29: Counter reset 30: Length count input 31: Length reset 32: Pulse input (enabled only for HDI) 33: Frequency modification enable 34: Acceleration/Deceleration prohibited 35: Motor selection terminal 1 36: Motor selection terminal 2(reserve) 37: Fault reset	0	

Code	Parameter Name	Setting range	Default	Property
b3-08	DI9 function selection(extend)	38: Normally open (NO) input of external fault 39: Normally closed (NC) input of external fault	0	
b3-09	DI10 function selection(extend)	40: User-defined fault 1 41: User-defined fault 2 42: Running pause 43: Free stop	0	
b3-10	DI11 function selection(extend)(extend)	44: Emergency stop 45: External STOP terminal 1 46: External STOP terminal 2 47: Deceleration DC braking	0	
b3-11	DI12 function selection(extend)	48: Immediate DC braking 49: Clear the current running time	0	
b3-12	DI filter time	0.000s~1.000s	0.010s	
b3-13	Terminal command mode	0: Two-line mode 1 1: Two-line mode 2 2: Three-line mode 1 3: Three-line mode 2	0	
b3-14	Terminal UP/DOWN rate	0.001Hz/s~65.535 Hz/s	0.100 Hz/s	
b3-15	DI1 ON delay time	0.0s~3000.0s	0.0s	
b3-16	DI1 OFF delay time	0.0s~3000.0s	0.0s	
b3-17	DI2 ON delay time	0.0s~3000.0s	0.0s	
b3-18	DI2 OFF delay time	0.0s~3000.0s	0.0s	
b3-19	DI3 ON delay time	0.0s~3000.0s	0.0s	
b3-20	DI3 OFF delay time	0.0s~3000.0s	0.0s	
b3-21	DI4 ON delay time	0.0s~3000.0s	0.0s	
b3-22	DI4 OFF delay time	0.0s~3000.0s	0.0s	
b3-23	DI5 ON delay time	0.0s~3000.0s	0.0s	
b3-24	DI5 OFF delay time	0.0s~3000.0s	0.0s	
b3-25	DI valid selection 1	Unit's digit: DI1 valid mode. 0: Low level valid 1: High level valid Ten's digit: DI2 valid mode. 0, 1 (same as DI1) Hundred's digit: DI3 valid mode. 0, 1 (same as DI1) Thousand's digit: DI4 valid mode. 0, 1 (same as DI1) Ten thousand's digit: DI5 valid mode. 0, 1 (same as DI1)	00000	

Code	Parameter Name	Setting range	Default	Property
b3-26	DI valid selection 2	Unit's digit: DI6 valid mode. 0, 1 (same as DI1) Ten's digit: DI7 valid mode. 0, 1 (same as DI1) Hundred's digit: DI8 state. 0, 1 (same as DI1) Thousand's digit: DI9 valid mode. 0, 1 (same as DI1) Ten thousand's digit: DI10 valid mode. 0, 1 (same as DI1)	00000	
b3-27	DI valid selection 3	Unit's digit: DI11 valid mode. 0, 1 (same as DI1) Ten's digit: DI12 valid mode. 0, 1 (same as DI1)	00	
Group b4: Switch Signal output Terminals				
b4-00	FM terminal output mode	0: Pulse output (FMP) 1: Switch signal output (FMR)	1	
b4-01	FMR function (open-collector output terminal)	0: No output 1: Ready signal 2: Frequency inverter running 3: Fault output (free stop fault) 4: Fault output (free stop fault, but do not output when lower voltage)	0	
b4-02	Relay 1 function (TA-TB-TC)	5: Swing frequency limit 6: Torque limit 7: Frequency upper limit reached 8: Frequency lower limit reached (relevant to running) 9: Frequency lower limit reached (having output at stop)	2	
b4-03	Reserved	10: Reverse running 11: Zero-speed running (no output at stop) 12: Zero-speed running 2 (having output at stop) 13: Preset count value reached		
b4-04	DO1 function selection (open-collector output terminal)	14: Designated count value reached 15: Length reached 16: PLC cycle complete 17: Frequency-level detection FDT1 output 18: Frequency level detection FDT2 output 19: Frequency reached	1	
b4-05	DO2 function(extend)	20: Frequency 1 reached 21: Frequency 2 reached 22: Current 1 reached 23: Current 2 reached 24: Module temperature reached 25: Timing reached	0	

Code	Parameter Name	Setting range	Default	Property
b4-06	DO3 function(extend)	26: Zero current state 27: Output current exceeded limitation 28: Lower voltage state output	0	
b4-07	DO4 function(extend)	29: Frequency inverter overload pre-warning 30: Motor overheat pre-warning 31: Motor overload pre-warning	0	
b4-08	DO5 function(extend)	32: off load 33: AI1 larger than AI2 34: AI1 input exceeded limitation	0	
b4-09	DO6 function(extend)	35: Alarm output (all faults) 36: Present running time reached 37: Accumulative power-on time reached 38: Accumulative running time reached	0	
b4-10	FMR ON delay time	0.0s~3000.0s	0.0s	
b4-11	FMR OFF delay time	0.0s~3000.0s	0.0s	
b4-12	Relay 1 ON delay time	0.0s~3000.0s	0.0s	
b4-13	Relay 1 OFF delay time	0.0s~3000.0s	0.0s	
b4-16	DO1 ON delay time	0.0s~3000.0s	0.0s	
b4-17	DO1 OFF delay time	0.0s~3000.0s	0.0s	
b4-18	DO2 ON delay time	0.0s~3000.0s	0.0s	
b4-19	DO2 OFF delay time	0.0s~3000.0s	0.0s	
b4-20	DO logic selection 1	Unit's digit: FMR valid mode. 0: Positive logic 1: Negative logic Ten's digit: Relay 1 valid mode. 0, 1 (same as FMR) Hundred's digit: Relay 2 valid mode. 0, 1 (same as FMR) Thousand's digit: DO1 valid mode. 0, 1 (same as FMR) Ten thousand's digit: DO2 valid mode. 0, 1 (same as FMR)	00000	
b4-21	DO logic selection 2	Unit's digit: DO3 valid mode. 0: Positive logic 1: Negative logic Ten's digit: DO4 valid mode. 0, 1 (same as FMR) Hundred's digit: DO5 valid mode. 0, 1 (same as FMR) Thousand's digit: DO6 valid mode. 0, 1 (same as FMR) Ten thousand's digit: reserved	00000	
b4-22	Frequency detection value (FDT1)	0.00 Hz~ maximum frequency	50.00 Hz	
b4-23	Frequency detection hysteresis (FDT hysteresis 1)	0.0%~100.0% (FDT1 level)	5.0%	

Code	Parameter Name	Setting range	Default	Property
b4-24	Frequency detection value (FDT2)	0.00Hz ~ maximum frequency	50.00 Hz	
b4-25	Frequency detection hysteresis (FDT hysteresis 2)	0.0%~100.0% (FDT2 level)	5.0%	
b4-26	Detection amplitude of frequency reached	0.00~100% (maximum frequency)	3.0%	
b4-27	Any frequency reaching detection value 1	0.00 Hz ~ maximum frequency	50.00 Hz	
b4-28	Any frequency reaching detection amplitude 1	0.0%~100.0% (maximum frequency)	3.0%	
b4-29	Any frequency reaching detection value 2	0.00 Hz ~ maximum frequency	50.00 Hz	
b4-30	Any frequency reaching detection amplitude 2	0.0%~100.0% (maximum frequency)	3.0%	
b4-31	Zero current detection level	0.0%~100.0% (rated motor current)	5.0%	
b4-32	Zero current detection delay time	0.00s~600.00s	0.10s	
b4-33	Over current output threshold	0.0%~300.0% (rated motor current)	200.0%	
b4-34	Over current output detection delay time	0.00s~600.00s	0.10s	
b4-35	Any current reaching 1	0.0%~100.0% (rated motor current)	100.0%	
b4-36	Amplitude of any current reaching 1	0.0%~100.0% (rated motor current)	3.0%	
b4-37	Any current reaching 2	0.0%~100.0% (rated motor current)	100.0%	
b4-38	Amplitude of any current reaching 2	0.0%~100.0% (rated motor current)	3.0%	
b4-39	Module temperature threshold	25~100°C	75°C	
Group b5: Pulse/Analog input terminals				
b5-00	Pulse minimum input(HDI6)	0.00 kHz ~b5-02	0.00 kHz	
b5-01	Corresponding setting of pulse minimum input	-100.00% ~100.0%	0.00%	
b5-02	Pulse maximum input	b5-00 ~ 50.00 kHz	50.00 kHz	
b5-03	Corresponding setting of pulse maximum input	-100.00% ~100.0%	100.0%	
b5-04	Pulse filter time	0.00s~10.00s	10.00s	
b5-05	All input voltage lower limit of protection	0.00 V~ b5-06	3.10 V	
b5-06	All input voltage upper limit of protection	b5-05~10.00 V	6.80 V	
b5-07	All input minimum value	0.00 V ~ b5-15	0.00 V	

Code	Parameter Name	Setting range	Default	Property
b5-08	Corresponding setting of AI1 minimum input	-100.00% ~100.0%	0.0%	
b5-09	Second point input value of AI1	0.00 V~10.00 V	2.50V	
b5-10	Corresponding setting of second point input value of AI1	-100.0% ~100.0%	25.0%	
b5-11	Third point input value of AI1	0.00 V~10.00 V	5.00V	
b5-12	Corresponding setting of third point input value of AI1	-100.0% ~100.0%	50.0%	
b5-13	Fourth point input value of AI1	0.00 V~10.00 V	7.50V	
b5-14	Corresponding setting of fourth point input value of AI1	-100.0% ~100.0%	75.0%	
b5-15	AI1 input maximum value	0.00 V ~ 10.00 V	10.00 V	
b5-16	Corresponding setting of AI1 maximum input	-100.00% ~100.0%	100.0%	
b5-17	AI1 input filter time	0.00s~10.00s	0.10s	
b5-18	Jump point of AI1 input corresponding setting	-100.0% ~100.0%	0.0%	
b5-19	Jump amplitude of AI1 input corresponding setting	0.0%~100.0%	0.5%	
b5-20	AI2 minimum input	0.00 V ~ 10.00 V	0.00 V	
b5-21	Corresponding setting of AI2 minimum input	-100.00% ~100.0%	0.0%	
b5-22	Second point input value of AI2	0.00 V ~10.00 V	2.50V	
b5-23	Corresponding setting of second point input value of AI2	-100.00% ~100.0%	25.0%	
b5-24	Third point input value of AI2	0.00 V ~ 10.00 V	5.00V	
b5-25	Corresponding setting of third point input value of AI2	-100.00% ~100.0%	50.0%	
b5-26	Fourth point input value of AI2	0.00 V ~ 10.00 V	7.50V	
b5-27	Corresponding setting of fourth point input value of AI2	-100.00% ~100.0%	75.0%	
b5-28	AI2 maximum input	0.00V~ 10.00 V	10.00 V	
b5-29	Corresponding setting	-100.00%~100.0%	100.0%	

Code	Parameter Name	Setting range	Default	Property
	of AI2 maximum input			
b5-30	AI2 input filter time	0.00s~10.00s	0.10s	
b5-31	Jump point of AI2 input corresponding setting	-100.0%~100.0%	0.0%	
b5-32	Jump amplitude of AI2 input corresponding setting	0.0% ~100.0%	0.5%	
b5-33	AI3 minimum input	0.00 V~10.00 V	0.00 V	
b5-34	Corresponding setting of AI3 minimum input	-100.00%~100.0%	0.0%	
b5-35	Second point input value of AI3	0.00 V ~ 10.00 V	2.50V	
b5-36	Corresponding setting of second point input value of AI3	-100.00% ~100.0%	25.0%	
b5-37	Third point input value of AI3	0.00 V ~ 10.00 V	5.00V	
b5-38	Corresponding setting of third point input value of AI3	-100.00% ~100.0%	50.0%	
b5-39	Fourth point input value of AI3	0.00 V ~ 10.00 V	7.50V	
b5-40	Corresponding setting of fourth point	-100.00% ~100.0%	75.0%	
b5-41	AI3 maximum input	0.00 V ~ 10.00 V	10.00 V	
b5-42	Corresponding setting of AI3 maximum input	-100.00% ~100.0%	100.0%	
b5-43	AI3 filter time	0.00~10.00s	0.10s	
b5-44	Jump point of AI3 input corresponding setting	-100.0% ~100.0%	0.0%	
b5-45	Jump amplitude of AI3 input corresponding setting	0.0% ~100.0%	0.5%	
Group b6: Pulse/Analog Output Terminals				
b6-00	FMP function selection	0: Running frequency corresponding to 0~Max. operation frequency 1: Set frequency corresponding to 0~Max. operation frequency 2: Output current corresponding to 0~Doubled motor rated current 3: Output torque (absolute value) corresponding to 0~double rated torque 4: Output power corresponding to 0~Doubled motor rated power 5: Output voltage corresponding to 0~1.2 times DC bus voltage	0	

Code	Parameter Name	Setting range	Default	Property
b6-01	AO1 output function selection	6: Motor rotational speed corresponding to 0~Max. operation frequency 7: Output current corresponding to 0~1000A 8: Output voltage corresponding to 0~1000V 9: Output torque corresponding to (-200%~200%) motor rated torque 10: Pulse input corresponding to 0Hz~100kHz	0	
b6-02	AO2 output function selection	11: AI1 corresponding to 0~10V 12: AI2 corresponding to 0~10V 13: AI3 corresponding to 0~10V 14: Length corresponding to 0~Length setting value 15: Count value corresponding to 0~Count setting value 16: Communication setting corresponding to 0~32767	1	
b6-03	Maximum FMP output frequency	0.01 kHz ~50.00 kHz	50.00 kHz	
b6-04	AO1 offset coefficient	-100.0% ~100.0%	0.0%	
b6-05	AO1 gain	-10.00~10.00	1.00	
b6-06	AO2 offset coefficient	-100.0% ~100.0%	0.00%	
b6-07	AO2 gain	-10.00 ~10.00	1.00	
Group b7 : Virtual DI (VDI)/Virtual DO (VDO)				
b7-00	VDI1 function selection	0~49	0	
b7-01	VDI2 function selection	0~49	0	
b7-02	VDI3 function selection	0~49	0	
b7-03	VDI4 function selection	0~49	0	
b7-04	VDI5 function selection	0~49	0	
b7-05	VDI state setting mode	Unit's digit: VDI1. 0: Valid decided by state of VDOx 1: Valid decided by b7-06 Ten's digit: VDI2. 0, 1 (same as VDI1) Hundred's digit: VDI3. 0, 1 (same as VDI1) Thousand's digit: VDI4. 0, 1 (same as VDI1) Ten thousand's digit: VDI5. 0, 1 (same as VDI1)	00000	

Code	Parameter Name	Setting range	Default	Property
b7-06	VDI state setting	Unit's digit: VDI1. 0: Invalid 1: Valid Ten's digit: VDI2 0, 1 (same as VDI1) Hundred's digit: VDI3 0, 1 (same as VDI1) Thousand's digit: VDI4 0, 1 (same as VDI1) Ten thousand's digit: VDI5. 0, 1 (same as VDI1)	00000	
b7-07	Function selection for AI1 used as DI	0~49	0	
b7-08	Function selection for AI2 used as DI	0~49	0	
b7-09	Function selection for AI3 used as DI	0~49	0	
b7-10	Valid state selection for AI used as DI	Unit's digit: AI1. 0: High level valid 1: Low level valid Ten's digit: AI2. 0, 1 (same as unit's digit) Hundred's digit: AI3. 0, 1 (same as unit's digit)	0	
b7-11	VDO1 function selection	0: connect with physical DIx internally 1~38	38	
b7-12	VDO2 function selection	0: connect with physical DIx internally 1~38	38	
b7-13	VDO3 function selection	0: connect with physical DIx internally 1~38	38	
b7-14	VDO4 function selection	0:connect with physical DIx internally 1~38	38	
b7-15	VDO5 function selection	0: connect with physical DIx internally 1~38	38	
b7-16	VDO1 output delay	0.0s~3000.0s	0.0s	
b7-17	VDO2 output delay	0.0s~3000.0s	0.0s	
b7-18	VDO3 output delay	0.0s~3000.0s	0.0s	
b7-19	VDO4 output delay	0.0s~3000.0s	0.0s	
b7-20	VDO5 output delay	0.0s~3000.0s	0.0s	

Code	Parameter Name	Setting range	Default	Property
b7-21	VDO valid state selection	Unit's digit: VDO1. 0: Positive logic valid 1: Reverse logic valid Ten's digit: VDO2 0, 1 (same as unit's digit) Hundred's digit: VDO3. 0, 1 (same as unit's digit) Thousand's digit: VDO4. 0, 1 (same as unit's digit) Ten thousand's digit: VDO5. 0, 1 (same as unit's digit)	00000	
Group b8: AI/AO Correction				
b8-00	Ideal voltage of AI1 calibration 1	0.500~4.000 V	2.000V	
b8-01	Sampling voltage of AI1 calibration 1	0.500~4.000 V	2.000V	
b8-02	Ideal voltage of AI1 calibration 2	6.000~9.999 V	8.000V	
b8-03	Sampling voltage of AI1 calibration 2	6.000~9.999 V	8.000V	
b8-04	Ideal voltage of AI2 calibration 1	0.500~4.000 V	2.000V	
b8-05	Sampling voltage of AI2 calibration 1	0.500~4.000 V	2.000V	
b8-06	Ideal voltage of AI2 calibration 2	6.000~9.999 V	8.000V	
b8-07	Sampling voltage of AI2 calibration 2	6.000~9.999 V	8.000V	
b8-08	Ideal voltage of AI3 calibration 1	0.500~4.000 V	2.000V	
b8-09	Sampling voltage of AI3 calibration 1	0.500~4.000 V	2.000V	
b8-10	Ideal voltage of AI3 calibration 2	6.000~9.999 V	8.000V	
b8-11	Sampling voltage of AI3 calibration 2	6.000~9.999 V	8.000V	
b8-12	Ideal voltage of AO1 calibration 1	0.500~4.000 V	2.000V	
b8-13	Measured voltage of AO1 calibration 1	0.500~4.000 V	2.000V	
b8-14	Ideal voltage of AO1 calibration 2	6.000~9.999 V	8.000V	
b8-15	Measured voltage of AO1 calibration 2	6.000~9.999 V	8.000V	
b8-16	Ideal voltage of AO2 calibration 1	0.500~4.000 V	2.000V	

Code	Parameter Name	Setting range	Default	Property
b8-17	Measured voltage of AO2 calibration 1	0.500~4.000 V	2.000V	
b8-18	Ideal voltage of AO2 calibration 2	6.000~9.999 V	8.000V	
b8-19	Measured voltage of AO2 calibration 2	6.000~9.999 V	8.000V	
Group b9: Keypad and Display				
b9-00	STOP/RESET key function	0: STOP/RESET key enabled only in operation panel control 1: STOP/RESET key enabled in any operation mode	0	
b9-01	MF.K Key function selection	0: MF.K key disabled 1: Switchover between operation panel control and remote command control (terminal or communication) 2: Switchover between forward rotation and reverse rotation 3: Forward JOG 4: Reverse JOG	0	
b9-02	LED display running parameters 1	0000~FFFF Bit00: Running frequency 1 (Hz) Bit01: Set frequency (Hz) Bit02: DC Bus voltage (V) Bit03: Output voltage (V) Bit04: Output current (A) Bit05: Output power (kW) Bit06: Output torque (%) Bit07: DI input status Bit08: DO output status Bit09: AI1 voltage (V) Bit10: AI2 voltage (V) Bit11: AI3 voltage (V) Bit12: Count value Bit13: Length value Bit14: Load speed display Bit15: PID setting	0x1f	

Code	Parameter Name	Setting range	Default	Property
b9-03	LED display running parameters 2	0000~FFFF Bit00: PID feedback Bit01: PLC stage Bit02: Pulse input frequency (kHz) Bit03: Running frequency 2 (Hz) Bit04: Remaining running time Bit05: AI1 voltage before calibration (V) Bit06: AI2 voltage before calibration (V) Bit07: AI3 voltage before calibration (V) Bit08: Linear speed Bit09: present power-on time (Hour) Bit10: present running time (Min) Bit11: Heat sink temperature display () Bit12: Communication setting value Bit13: Encoder feedback frequency (Hz) Bit14: Main frequency X display (Hz) Bit15: Auxiliary frequency Y display (Hz)	0x0800	
b9-04	LED display parameter of stopping	0000~FFFF Bit00: Set frequency (Hz) Bit01: Bus voltage (V) Bit02: DI input status Bit03: DO output status Bit04: AI1 voltage (V) Bit05: AI2 voltage (V) Bit06: AI3 voltage (V) Bit07: Count value Bit08: Length value Bit09: PLC stage Bit10: Load speed Bit11: PID setting Bit12: Pulse setting frequency(kHz) Bit13:Heatsink temperature display(°C)	0x2033	
b9-05	Load speed display coefficient	0.0001~ 6.5000	1.0000	
b9-06	Number of decimal places for load speed display	0: 0 decimal display 1: 1 decimal display 2: 2 decimal display 3: 3 decimal display	1	
b9-07	Heatsink temperature	0.0°C ~100.0°C	0°C	
b9-08	Accumulative power-on time	0~65535 h	0 h	●
b9-09	Accumulative running time	0~65535 h	0 h	●
b9-10	Accumulative power consumption	0~65535 kWh	0 kWh	●
Group bA: Communication Parameters				
bA-00	Communication type selection	0: Modbus protocol	0	

Code	Parameter Name	Setting range	Default	Property
bA-01	Baud ratio setting	Unit's digit: Modbus baud ratio. 0: 300 BPS 1: 600 BPS 2: 1200 BPS 3: 2400 BPS 4: 4800 BPS 5: 9600 BPS 6: 19200 BPS 7: 38400 BPS	5	
bA-02	Modbus Data format	0: No check, data format <8,N,2> 1: Even parity check, data format<8,E,1> 2: Odd Parity check, data format<8,O,1> 3: No check, data format <8,N,1> Valid for Modbus	0	
bA-03	Broadcast address	0~247 (0: Broadcast address) Valid for Modbus	1	
bA-04	Modbus response delay	0~20 ms Only valid for Modbus	2 ms	
bA-05	Communication timeout	0.0s:invalid 0.1s~60.0s Valid for Modbus	0.0s	
bA-06	Modbus protocol data transmission format selection	Unit's digit: Modbus protocol. 0: Non-standard Modbus protocol 1: Standard Modbus protocol	1	
bA-07	Communication reading current resolution	0: 0.01A 1: 0.1A	0	
Group bb: Fault and Protection Setting				
bb-00	G/P type selection	0: P type 1: G type	1	
bb-01	Motor overload protection selection	0: Disabled 1: Enabled	0	
bb-02	Motor overload protection gain	0.20~10.00	1.00	
bb-03	Motor overload pre-warning coefficient	50%~100%	80%	
bb-04	Overvoltage stall gain	0~100	0	
bb-05	Overvoltage stall protective voltage	120%~150%	130%	
bb-06	Over current stall gain	0~100	20	
bb-07	Over current stall protective current	100%~200%	150%	
bb-08	Protection of short-circuit to ground after power-on	0: Disabled 1: Enabled	1	
bb-09	Fault auto reset times	0~99	0	
bb-10	Relay action selection during fault auto reset	0: Not act 1: Act	0	

Code	Parameter Name	Setting range	Default	Property
bb-11	Time interval of fault auto reset	0.1s~100.0s	1.0s	
bb-12	Input phase loss protection/contacting energizing protection selection	0: Disabled 1: Enabled	0	
bb-13	Output phase loss protection	0: Disabled 1: Enabled	0	
bb-14	Off load protection	0: Disabled 1: Enabled	0	
bb-15	Off load detection level	0.0%~100.0% (rated motor current)	1.0%	
bb-16	Off load detection time	0.0s~60.0s	1.0s	
bb-17	Over-speed detection value	0.0%~50.0% (maximum frequency)	20.0%	
bb-18	Over-speed detection time	0.0s~60.0s	1.0s	
bb-19	Detection value of too large speed deviation	0.0%~50.0% (maximum frequency)	20.0%	
bb-20	Detection time of too large speed deviation	0.0s~60.0s	5.0s	
bb-21	Action selection at instantaneous power failure	0: Invalid 1: Decelerate 2: Decelerate to stop	0	
bb-22	Voltage rally judging time at instantaneous power failure	0.00s ~100.00s	0.00s	
bb-23	Judging voltage of instantaneous power failure	60.0%~100.0% (standard bus voltage)	80.0%	
bb-24	Judging voltage of instantaneous power failure restoring	60.0%~100.0% (standard bus voltage)	90.0%	
bb-25	Type of motor temperature sensor	0: No temperature sensor 1: PT100 2: PT1000	0	
bb-26	Motor overheat protection threshold	0°C~200°C	120°C	
bb-27	Motor overheat pre-warning threshold	0°C~200°C	100°C	
bb-28	Overvoltage threshold	200.0~2500.0 V	830.0 V	
bb-29	Under voltage threshold	50.0%~150.0%	100.0%	
bb-30	Brake unit use ratio	0%~100%	100%	
bb-31	Rapid current limit	0: Disabled 1: Enabled	1	

Code	Parameter Name	Setting range	Default	Property
bb-32	Fault protection action selection 1	Unit's digit: Motor overload, Err11. 0: Free stop 1: Stop according to the stop mode 2: Continue to run Ten's digit: Power input phase loss, Err12. Same as unit's digit Hundred's digit: Power output phase loss, Err13. Same as unit's digit Thousand's digit: External equipment fault, Err15. Same as unit's digit Ten thousand's digit: Communication fault, Err16. Same as unit's digit	00000	
bb-33	Fault protection action selection 2	Unit's digit: Encoder/PG card fault, Err20. 0: Free stop Ten's digit: EEPROM read-write fault, Err21. 0: Free stop 1: Stop according to the stop mode Hundred's digit : Reserved Thousand's digit: Motor Overheat, Err25. Same as unit's digit in bb-32 Ten thousand's digit: Running time reached, Err26. Same as unit's digit in bb-32	00000	
bb-34	Fault protection action selection 3	Unit's digit: User-defined fault 1,Err27. Same as unit's digit in bb-32 Ten's digit: User-defined fault 2,Err28. Same as unit's digit in bb-32 Hundred's digit: Accumulative power-on time reached,Err29. Same as unit's digit in bb-32 Thousand's digit: Off load, Err30. 0: Free stop 1: Stop according to the stop mode 2: reduce to 7% of rated motor frequency and continue running. If the load recovers and it will auto regain to setting frequency. Ten thousand's digit: PID feedback lost during running, Err31. Same as unit's digit in bb-32	00000	

Code	Parameter Name	Setting range	Default	Property
bb-35	Fault protection action selection 4	Unit's digit: Speed deviation too large, Err42 Same as unit's digit in bb-32 Ten's digit: Motor over-speed, Err43. Same as unit's digit in bb-32 Hundred's digit: Initial position fault, Err51. Same as unit's digit in bb-32	00000	
bb-36	Frequency selection for continuing to run of fault	0: Current running frequency 1: Set frequency 2: Frequency upper limit 3: Frequency lower limit 4: Backup frequency of abnormality (bb-37)	0	
bb-37	Backup frequency of abnormality	0.0%~100.0% (maximum frequency)	1.0%	
Group bC: Fault diagnosis				
bC-00	1st fault type	–	–	●
bC-01	2nd fault type	–	–	●
bC-02	3rd fault type (latest)	–	–	●
bC-03	Frequency of latest fault	–	–	●
bC-04	Current of latest fault	–	–	●
bC-05	DC Bus voltage of latest fault	–	–	●
bC-06	Input terminals status of latest fault	–	–	●
bC-07	Output terminal status of latest fault	–	–	●
bC-08	Frequency inverter status of latest fault	–	–	●
bC-09	Power-on time of latest fault	–	–	●
bC-10	Running time of latest fault	–	–	●
bC-11	Frequency of 2nd fault	–	–	●
bC-12	Current of 2nd fault	–	–	●
bC-13	DC Bus voltage of 2nd fault	–	–	●
bC-14	Input terminal status of 2nd fault	–	–	●
bC-15	Output terminal status of 2nd fault	–	–	●
bC-16	Frequency inverter status of 2nd fault	–	–	●
bC-17	Power-on time of 2nd fault	–	–	●
bC-18	Running time of 2nd fault	–	–	●
bC-19	Frequency of 1st fault	–	–	●
bC-20	Current of 1st fault	–	–	●

Code	Parameter Name	Setting range	Default	Property
bC-21	DC Bus voltage of 1st fault	–	–	●
bC-22	Input terminal status of 1st fault	–	–	●
bC-23	Output terminal status of 1st fault	–	–	●
bC-24	Frequency inverter status of 1st fault	–	–	
bC-25	Power-on time of 1st fault	–	–	●
bC-26	Running time of 1st fault	–	–	●
Group C0: PID Control Function				
C0-00	PID setting source	0: C0-01 1: AI1 2: AI2 3: AI3 4: Pulse setting (DI6) 5: Communication setting 6: Multi-function	0	
C0-01	PID digital setting	0.0%~100.0%	50.0%	
C0-02	PID setting change time	0.00s~650.00s	0.00s	
C0-03	PID feedback source	0: AI1 1: AI2 2: AI3 3: Pulse setting (HDI) 4: AI1 – AI2 5: AI1 + AI2 6: MAX (AI1 , AI2) 7: MIN (AI1 , AI2) 8: Communication setting	0	
C0-04	PID action direction	0: Forward action 1: Reverse action	0	
C0-05	PID setting feedback range	0~65535	1000	
C0-06	Proportional gain KP1	0.00~10.0	20.0	
C0-07	Integral time TI1	0.01s~10.00s	2.00s	
C0-08	Differential time TD1	0.000s~10.000s	0.000s	
C0-09	Proportional gain KP2	0.00~10.00	20.0	
C0-10	Integral time TI2	0.01s~10.00s	2.00s	
C0-11	Differential time TD2	0.00s~10.00s	0.000s	
C0-12	PID parameter switchover condition	0: No switchover 1: Switchover via DI 2: Automatic switchover based on deviation	0	
C0-13	PID parameter switchover deviation 1	0.0% ~ C0-14	20.0%	
C0-14	PID parameter	C0-13 ~ 100.0%	80.0%	

Code	Parameter Name	Setting range	Default	Property
	switchover deviation 2			
C0-15	PID integral property	Unit's digit: Integral separated. 0: Invalid 1: Valid Ten's digit: Whether to stop integral operation when the output reaches the limit. 0: Continue integral operation 1: Stop integral operation	00	
C0-16	PID initial value	0.0%~100.0%	0.0%	
C0-17	PID initial value holding time	0.00s~650.00s	0.00s	
C0-18	Frequency upper limit of PID reverse rotation	0.00 ~ maximum frequency	2.00 Hz	
C0-19	PID deviation limit	0.0%~100.0%	0.0%	
C0-20	PID differential limit	0.00%~100.00%	0.10%	
C0-21	Maximum positive deviation between two PID outputs	0.00%~100.00%	1.00%	
C0-22	Maximum negative deviation between two PID outputs	0.00%~100.00%	1.00%	
C0-23	PID feedback filter time	0.00s~60.00s	0.00s	
C0-24	PID output filter time	0.00s~60.00s	0.00s	
C0-25	Detection value of PID feedback loss	0.0%: Not judging feedback loss 0.1%~100.0%	0.0%	
C0-26	Detection time of PID feedback loss	0.0s~20.0s	0.0s	
C0-27	PID operation at stop	0: No PID operation at stop 1: PID operation at stop	0	
Group C1: Multi-function				
C1-00	Multi-function 0	-100.0%~100.0%	0.0%	
C1-01	Multi-function 1	-100.0%~100.0%	0.0%	
C1-02	Multi-function 2	-100.0%~100.0%	0.0%	
C1-03	Multi-function 3	-100.0%~100.0%	0.0%	
C1-04	Multi-function 4	-100.0%~100.0%	0.0%	
C1-05	Multi-function 5	-100.0%~100.0%	0.0%	
C1-06	Multi-function 6	-100.0%~100.0%	0.0%	
C1-07	Multi-function 7	-100.0%~100.0%	0.0%	
C1-08	Multi-function 8	-100.0%~100.0%	0.0%	
C1-09	Multi-function 9	-100.0%~100.0%	0.0%	
C1-10	Multi-function 10	-100.0%~100.0%	0.0%	
C1-11	Multi-function 11	-100.0%~100.0%	0.0%	
C1-12	Multi-function 12	-100.0%~100.0%	0.0%	
C1-13	Multi-function 13	-100.0%~100.0%	0.0%	
C1-14	Multi-function 14	-100.0%~100.0%	0.0%	
C1-15	Multi-function 15	-100.0%~100.0%	0.0%	
C1-16	Multi-function 0 source	0: Set by C1-00	0	

Code	Parameter Name	Setting range	Default	Property
		1: A11 2: A12 3: A13 4: Pulse setting(DI6) 5: PID 6: Set by preset frequency (b0-12), modified via terminal UP/ DOWN		
Group C2: Simple PLC				
C2-00	Simple PLC running mode	0: Stop after the Frequency inverter runs one cycle 1: Keep final values after the frequency inverter runs one cycle 2: Repeat after the frequency inverter runs one cycle	0	
C2-01	Simple PLC record selection	Unit's digit: Record of power failure. 0: no record after power off 1: record after power off Ten's digit: Record of stopping. 0: no record after stopping 1: record after stopping	00	
C2-02	Running time of simple PLC Segment 0	0.0s(h)~6553.5s(h)	0.0s (h)	
C2-03	Acceleration/deceleration time of simple PLC Segment 0	0~3	0	
C2-04	Running time of simple PLC Segment 1	0.0s(h)~6553.5s(h)	0.0s (h)	
C2-05	Acceleration/deceleration time of simple PLC Segment 1	0~3	0	
C2-06	Running time of simple PLC Segment 2	0.0s(h)~6553.5s(h)	0.0s (h)	
C2-07	Acceleration/deceleration time of simple PLC Segment 2	0~3	0	
C2-08	Running time of simple PLC Segment 3	0.0s(h)~6553.5s(h)	0.0s (h)	
C2-09	Acceleration/deceleration time of simple PLC Segment 3	0~3	0	
C2-10	Running time of simple PLC Segment 4	0.0s(h)~6553.5s(h)	0.0s (h)	
C2-11	Acceleration/deceleration time of simple PLC Segment 4	0~3	0	
C2-12	Running time of simple PLC Segment 5	0.0s(h)~6553.5s(h)	0.0s (h)	

Code	Parameter Name	Setting range	Default	Property
C2-13	Acceleration/deceleration time of simple PLC Segment 5	0~3	0	
C2-14	Running time of simple PLC Segment 6	0.0s(h)~6553.5s(h)	0.0s (h)	
C2-15	Acceleration/deceleration time of simple PLC Segment 6	0~3	0	
C2-16	Running time of simple PLC Segment 7	0.0s(h)~6553.5s(h)	0.0s (h)	
C2-17	Acceleration/deceleration time of simple PLC Segment 7	0~3	0	
C2-18	Running time of simple PLC Segment 8	0.0s(h)~6553.5s(h)	0.0s (h)	
C2-19	Acceleration/deceleration time of simple PLC Segment 8	0~3	0	
C2-20	Running time of simple PLC Segment 9	0.0s(h)~6553.5s(h)	0.0s (h)	
C2-21	Acceleration/deceleration time of simple PLC Segment 9	0~3	0	
C2-22	Running time of simple PLC Segment 10	0.0s(h)~6553.5s(h)	0.0s (h)	
C2-23	Acceleration/deceleration time of simple PLC Segment 10	0~3	0	
C2-24	Running time of simple PLC Segment 11	0.0s(h)~6553.5s(h)	0.0s (h)	
C2-25	Acceleration/deceleration time of simple PLC Segment 11	0~3	0	
C2-26	Running time of simple PLC Segment 12	0.0s(h)~6553.5s(h)	0.0s (h)	
C2-27	Acceleration/deceleration time of simple PLC Segment 12	0~3	0	
C2-28	Running time of simple PLC Segment 13	0.0s(h)~6553.5s(h)	0.0s (h)	
C2-29	Acceleration/deceleration time of simple PLC Segment 13	0~3	0	
C2-30	Running time of simple PLC Segment 14	0.0s(h)~6553.5s(h)	0.0s (h)	
C2-31	Acceleration/deceleration time of simple PLC	0~3	0	

Code	Parameter Name	Setting range	Default	Property
	Segment 14			
C2-32	Running time of simple PLC Segment 15	0.0s(h)~6553.5s(h)	0.0s (h)	
C2-33	Acceleration/deceleration time of simple PLC Segment 15	0~3	0	
C2-34	Time unit of simple PLC running	0: s (second) 1: h (hour)	0	
Group C3: Swing Frequency, Fixed Length and Count				
C3-00	Swing frequency setting mode	0: Relative to the central frequency 1: Relative to the maximum frequency	0	
C3-01	Swing frequency amplitude	0.0%~100.0%	0.0%	
C3-02	Textile jump frequency amplitude of Swing running	0.0%~50.0%	0.0%	
C3-03	Swing frequency cycle	0.1s~3000.0s	10.0s	
C3-04	Triangular wave rising time coefficient	0.1%~100.0%	50.0%	
C3-05	Set length	0m~65535 m	1000 m	
C3-06	Actual length	0m~65535 m	0 m	
C3-07	Number of pulses per meter	0.1~6553.5	100.0	
C3-08	Set count value	1~65535	1000	
C3-09	Designated count value	1~65535	1000	
Group d0: Motor 1 Parameters				
d0-00	Rated motor power	0.1kw~1000.0 kW	Model dependent	
d0-01	Rated motor voltage	1V~2000 V	Model dependent	
d0-02	Rated motor current	0.01A~655.35 A (Frequency inverter power ≤55 kW) 0.1A~6553.5 A (Frequency inverter power ≥75 kW)	Model dependent	
d0-03	Rated motor frequency	0.01 Hz~ maximum frequency	50.00Hz	
d0-04	Rated motor rotational speed	1rpm~65535rpm	Model dependent	
d0-05	Stator resistance (asynchronous motor)	0.001 Ω ~65.535 Ω (frequency inverter power ≤ 55 kW) 0.0001 Ω ~6.5535 Ω (frequency inverter power ≥75 kW)	Model dependent	
d0-06	Rotor resistance (asynchronous motor)	0.001 Ω ~65.535 Ω (Frequency inverter power ≤ 55 kW) 0.0001 Ω ~6.5535 Ω (Frequency inverter power ≥75 kW)	Model dependent	
d0-07	Leakage inductive reactance (asynchronous)	0.01mH~655.35 mH (Frequency inverter power ≤ 55 kW)	Model dependent	

Code	Parameter Name	Setting range	Default	Property
	motor)	0.001mH~65.535 mH (Frequency inverter power \geq 75 kW)		
d0-08	Mutual inductive reactance (asynchronous motor)	0.1mH~6553.5 mH (Frequency inverter power \leq 55 kW) 0.01mH~655.35 mH (Frequency inverter power \geq 75 kW)	Model dependent	
d0-09	No-load current (asynchronous motor)	0.01A ~ d0-02 (Frequency inverter power \leq 55 kW) 0.1A to d0-02 (Frequency inverter power \geq 75 kW)	Model dependent	
d0-15	Stator resistance (synchronous motor)	0.001 Ω ~65.535 Ω (Frequency inverter power \leq 55 kW) 0.0001 Ω ~ 6.5535 Ω (Frequency inverter power \geq 75 kW)	Model dependent	
d0-16	Shaft D inductance (synchronous motor)	0.01 mH ~655.35 mH (Frequency inverter power \leq 55 kW) 0.001~65.535 mH (Frequency inverter power \geq 75 kW)	Model dependent	
d0-17	Shaft Q inductance (synchronous motor)	0.01 mH ~655.35 mH (Frequency inverter power \leq 55 kW) 0.001 mH~65.535 mH (Frequency inverter power \geq 75 kW)	Model dependent	
d0-18	Back EMF (synchronous motor)	0.1V~6553.5 V	Model dependent	
d0-19	Encoder pulses per revolution	1~32767	1024	
d0-20	Encoder type	0: ABZ incremental encoder 1: Resolver 2: UVW incremental encoder 3: Reserved 4: Wire-saving UVW encoder	0	
d0-21	A/B phase sequence of ABZ incremental encoder	0: Forward 1: Reserve	0	
d0-22	Encoder installation angle	0.0°~359.9°	0.0°	
d0-23	U, V, W phase sequence of UVW encoder	0: Forward 1: Reverse	0	
d0-24	UVW encoder angle offset	0.0°~359.9°	0.0°	
d0-28	Number of pole pairs of resolver	1~99	1	
d0-29	Encoder wire-break fault detection time	0.0s: No action 0.1s~10.0s	0.0s	
d0-30	Motor 1 auto-tuning selection	0: No auto-tuning 1: Asynchronous motor static auto-tuning 2: Asynchronous motor complete	0	

Code	Parameter Name	Setting range	Default	Property
		auto-tuning 11: Synchronous motor with-load auto-tuning 12: Synchronous motor no-load auto-tuning		
Group d1: Vector Control Parameters				
d1-00	Speed/Torque control selection	0: Speed control 1: Torque control	0	
d1-01	Speed loop proportional gain 1(Kp1)	0.01~10.00	0.30	
d1-02	Speed loop integral time 1(Ti1)	0.01s~10.00s	0.50s	
d1-03	Switchover frequency 1	0.00 ~ d1-06	5.00 Hz	
d1-04	Speed loop proportional gain 2(KP2)	0.01~10.00	0.20	
d1-05	Speed loop integral time 2(Ti2)	0.01s~10.00s	1.00s	
d1-06	Switchover frequency 2	d1-03~ maximum output frequency	10.00 Hz	
d1-07	Speed loop integral property	0: Integral separation disabled 1: Integral separation enabled	0	
d1-08	ASR input filtering time	0.000s~0.100s	0.000s	
d1-09	ASR output filtering time	0.000s~0.100s	0.000s	
d1-10	Excitation current loop proportional gain	0~30000	2000	
d1-11	Excitation current loop integral gain	0~30000	1300	
d1-12	Torque current loop proportional gain	0~30000	2000	
d1-13	Torque current loop integral gain	0~30000	1300	
d1-14	Motor running torque upper limit source in speed control mode	0: d1-16 1: AI1 2: AI2 3: AI3 4: Pulse setting (DI6) 5: Communication setting	0	
d1-15	Braking torque upper limit source in speed control mode	0: d1-17 1: AI1 2: AI2 3: AI3 4: Pulse setting (DI6) 5: Communication setting	0	
d1-16	Digital setting of motor running torque limit	0.0%~200.0%	150.0%	
d1-17	Digital setting of braking torque limit	0.0%~200.0%	150.0%	

Code	Parameter Name	Setting range	Default	Property
d1-18	Motor running slip gain	50%~200%	100%	
d1-19	Braking slip gain	50%~200%	100%	
d1-20	Torque limit coefficient in field weakening area	0.0%~100.0%	40.0%	
d1-21	PM field weakening mode of synchronous motor	0: Invalid field weakening 1: Direct calculation 2: Automatic adjustment	1	
d1-22	PM field weakening depth of synchronous motor	50%~500%	100%	
d1-23	Maximum current of PM field weakening	1%~300%	50%	
d1-24	PM Field weakening automatic adjustment gain	0.10~5.00	1.00	
d1-25	PM Field weakening integral multiple	2~10	2	
d1-26	Torque setting source in torque control	0: Digital setting (d1-27) 1: AI1 2: AI2 3: AI3 4: Pulse setting (DI6) 5: Communication setting 6: MIN (AI1, AI2) 7: MAX (AI1, AI2) Full range of values 1~7 corresponds to the digital setting of d1-27.	0	
d1-27	Torque digital setting in torque control	-200.0%~200.0%	100.0%	
d1-28	Forward speed limit in torque control	0: Digital setting 1: AI1 2: AI2 3: AI3 4: Pulse setting(DI6) 5: Communication setting	0	
d1-29	Reverse speed limit in torque control	0: Digital setting 1: AI1 2: AI2 3: AI3 4: Pulse setting(DI6) 5: Communication setting	0	
d1-30	Forward maximum frequency in torque control	0.00 Hz ~ maximum frequency(b0-13)	50.00 Hz	
d1-31	Reverse maximum frequency in torque control	0.00 Hz ~ maximum frequency(b0-13)	50.00 Hz	

Code	Parameter Name	Setting range	Default	Property
d1-32	Acceleration time in torque control	0.00s~120.00s	0.10s	
d1-33	Deceleration time in torque control	0.00s~120.00s	0.10s	
Group d2: V/F Control Parameters				
d2-00	V/F curve setting	0: Linear V/F 1: Multi-point V/F 2: Square V/F 3: 1.2-power V/F 4: 1.4-power V/F 6: 1.6-power V/F 8: 1.8-power V/F 10: V/F complete separation 11: V/F half separation	0	
d2-01	Torque boost	0.0% (torque auto-boost) 0.1%~30.0%	0	
d2-02	Cut-off frequency of torque boost	0.0%~80.0% Actual cut-off frequency= Motor rated frequency*(d2-02)	50.0%	
d2-03	Multi-point V/F frequency 1 (F1)	0.00 Hz ~ d2-05	0.00 Hz	
d2-04	Multi-point V/F voltage 1 (V1)	0.0%~100.0%	0.0%	
d2-05	Multi-point V/F frequency 2 (F2)	d2-03 to d2-07	0.00 Hz	
d2-06	Multi-point V/F voltage 2 (V2)	0.0%~100.0%	0.0%	
d2-07	Multi-point V/F frequency 3 (F3)	d2-05 ~ maximum frequency	0.00 Hz	
d2-08	Multi-point V/F voltage 3 (V3)	0.0%~100.0%	0.0%	
d2-09	V/F slip compensation coefficient	0.0%~200.0%	0.0%	
d2-10	V/F oscillation suppression gain	0~100	0	
d2-12	Voltage source for V/F separation	0: Digital setting (d2-13) 1: AI1 2: AI2 3: AI3 4: Pulse setting (DI6) 5: Multi-function 6: Simple PLC 7: PID 8: Communication setting (Note: 100.0% corresponds to the rated motor voltage)	0	
d2-13	Voltage digital setting	0 V ~ rated motor voltage	0 V	

Code	Parameter Name	Setting range	Default	Property
	for V/F separation			
d2-14	Voltage rise time of V/F separation	0.0s~1000.0s Note: It indicates the time for the voltage rising from 0 V ~ rated motor voltage.	0.0s	
Group d3: Motor 2 Parameters				
d3-00	Rated motor power	0.1kw~1000.0 kW	Model dependent	
d3-01	Rated motor voltage	1V~2000 V	Model dependent	
d3-02	Rated motor current	0.01A~655.35 A (Frequency inverter power ≤55 kW) 0.1A~6553.5 A (Frequency inverter power ≥75 kW)	Model dependent	
d3-03	Rated motor frequency	0.01 Hz~ maximum frequency	50.00Hz	
d3-04	Rated motor rotational speed	1rpm~65535rpm	Model dependent	
d3-05	Stator resistance (asynchronous motor)	0.001Ω~65.535 Ω (Frequency inverter power ≤ 55 kW) 0.0001Ω~6.5535 Ω (Frequency inverter power ≥75 kW)	Model dependent	
d3-06	Rotor resistance (asynchronous motor)	0.001Ω~65.535 Ω (Frequency inverter power ≤ 55 kW) 0.0001Ω~6.5535 Ω (Frequency inverter power ≥75 kW)	Model dependent	
d3-07	Leakage inductive reactance (asynchronous motor)	0.01mH~655.35 mH (Frequency inverter power ≤ 55 kW) 0.001mH~65.535 mH (Frequency inverter power ≥75 kW)	Model dependent	
d3-08	Mutual inductive reactance (asynchronous motor)	0.1mH~6553.5 mH (Frequency inverter power ≤ 55 kW) 0.01mH~655.35 mH (Frequency inverter power ≥75 kW)	Model dependent	
d3-09	No-load current (asynchronous motor)	0.01 A ~ d3-02 (Frequency inverter power ≤ 55 kW) 0.1 A ~ d3-02 (Frequency inverter power ≥75 kW)	Model dependent	
d3-15	Stator resistance (synchronous motor)	0.001Ω~65.535 Ω (Frequency inverter power ≤ 55 kW) 0.0001Ω~6.5535 Ω (Frequency inverter power ≥75 kW)	Model dependent	
d3-16	Shaft D inductance (synchronous motor)	0.01mH~655.35 mH (Frequency inverter power ≤ 55 kW) 0.001mH~65.535 mH (Frequency inverter power ≥ 75 kW)	Model dependent	
d3-17	Shaft Q inductance (synchronous motor)	0.01mH~655.35 mH (Frequency inverter power ≤ 55 kW) 0.001mH~65.535 mH (Frequency inverter	Model dependent	

Code	Parameter Name	Setting range	Default	Property
		power ≥75 kW)		
d3-18	Back EMF (synchronous motor)	0.1V~6553.5 V	Model dependent	
d3-19	Encoder pulses per revolution	1~32767	1024	
d3-20	Encoder type	0: ABZ incremental encoder 1: Resolver 2: UVW incremental encoder 3: Reversed 4: Wire-saving UVW encoder	0	
d3-21	A, B phase sequence of ABZ incremental encoder	0: Forward 1: Reserve	0	
d3-22	Encoder installation angle	0.0°~ 359.9°	0.0°	
d3-23	U, V, W phase sequence of UVW encoder	0: Forward 1: Reverse	0	
d3-24	UVW encoder angle offset	0.0°~ 359.9°	0.0°	
d3-28	Number of pole pairs of resolver	1~99	1	
d3-29	Encoder wire-break fault detection time	0.0s: No action 0.1s~10.0s	0.0s	
d3-30	Motor 2 auto-tuning selection	0: No auto-tuning 1: Asynchronous motor static auto-tuning 2: Asynchronous motor complete auto-tuning 11: Synchronous motor with-load auto-tuning 12: Synchronous motor no-load auto-tuning	0	
Group d4: Motor 2 Vector Control Parameters				
d4-00	Speed/Torque control selection	0: Speed control 1: Torque control mode	0	
d4-01	Speed loop proportional gain 1(Kp1)	0.01~10.00	0.30	
d4-02	Speed loop integral time 1(Ti1)	0.01s~10.00s	0.50s	
d4-03	Switchover frequency 1	0.00Hz ~ d4-06	5.00 Hz	
d4-04	Speed loop proportional gain 2(Kp2)	0.01~10.00	0.20	
d4-05	Speed loop integral time 2(Ti2)	0.01s~10.00s	1.00s	
d4-06	Switchover frequency 2	d4-03 ~ maximum output frequency	10.00 Hz	
d4-07	Speed loop integral property	0: Integral separated disabled 1: Integral separated enabled	0	
d4-08	ASR input filtering time	0.000s~0.100s	0.000s	
d4-09	ASR output filtering	0.000s~0.100s	0.000s	

Code	Parameter Name	Setting range	Default	Property
	time			
d4-10	Excitation current loop proportional gain	0~30000	2000	
d4-11	Excitation current loop integral gain	0~30000	1300	
d4-12	Torque current loop proportional gain	0~30000	2000	
d4-13	Torque current loop integral gain	0~30000	1300	
d4-14	Motor-driven torque upper limit source in speed control mode	0: d4-16 1: AI1 2: AI2 3: AI3 4: Pulse setting (DI6) 5: Communication setting	0	
d4-15	Braking torque upper limit source in speed control mode	0: d4-17 1: AI1 2: AI2 3: AI3 4: Pulse setting (DI6) 5: Communication setting	0	
d4-16	Digital setting of motor-driven torque limit	0.0%~200.0%	150.0%	
d4-17	Digital setting of braking torque limit	0.0%~200.0%	150.0%	
d4-18	Motor-driven slip gain	50%~200%	100%	
d4-19	Braking slip gain	50%~200%	100%	
d4-20	Torque limit coefficient in field weakening area	0.0%~100.0%	40.0%	
d4-21	PM Field weakening mode of synchronous motor	0: Invalid field weakening 1: Direct calculation 2: Adjustment	1	
d4-22	PM Field weakening degree of synchronous motor	50%~500%	100%	
d4-23	Maximum PM field weakening current	1%~300%	50%	
d4-24	PM Field weakening automatic adjustment gain	0.10~5.00	1.00	
d4-25	PM Field weakening integral gain	2~10	2	

Code	Parameter Name	Setting range	Default	Property
d4-26	Torque setting source in torque control	0: Digital setting (d4-27) 1: AI1 2: AI2 3: AI3 4: Pulse setting 5: Communication setting 6: MIN (AI1, AI2) 7: MAX (AI1, AI2) Full range of values 1~7 corresponds to the digital setting of d4-27.	0	
d4-27	Torque digital setting in torque control	-200.0%~200.0%	100.0%	
d4-28	Forward speed limit in torque control	0: Digital setting 1: AI1 2: AI2 3: AI3 4: Pulse setting 5: Communication setting	0	
d4-29	Reverse speed limit in torque control	0: Digital setting 1: AI1 2: AI2 3: AI3 4: Pulse setting 5: Communication setting	0	
d4-30	Forward maximum frequency in torque control	0.00 Hz ~ maximum frequency(b0-13)	50.00 Hz	
d4-31	Reverse maximum frequency in torque control	0.00 Hz ~ maximum frequency(b0-13)	50.00 Hz	
d4-32	Acceleration time in torque control	0.00s~120.00s	0.10s	
d4-33	Deceleration time in torque control	0.00s~120.00s	0.10s	
Group d5: Motor 2 V/F control parameters				
d5-00	V/F curve setting	0: Linear V/F 1: Multi-point V/F 2: Square V/F 3: 1.2-power V/F 4: 1.4-power V/F 6: 1.6-power V/F 8: 1.8-power V/F 10: V/F complete separation 11: V/F half separation	0	
d5-01	Torque boost	0.0% (Automatic torque boost) 0.1%~30.0%	0	

Code	Parameter Name	Setting range	Default	Property
d5-02	Cut-off frequency of torque boost	0.0%~80.0% Actual cut-off frequency= Motor rated frequency*d5-02	50.0%	
d5-03	Multi-point V/F frequency 1 (F1)	0.00 Hz ~ d5-05	0.00 Hz	
d5-04	Multi-point V/F voltage 1 (V1)	0.0%~100.0%	0.0%	
d5-05	Multi-point V/F frequency 2 (F2)	d5-03 ~ d5-07	0.00 Hz	
d5-06	Multi-point V/F voltage 2 (V2)	0.0%~100.0%	0.0%	
d5-07	Multi-point V/F frequency 3 (F3)	d5-05 ~ Maximum frequency(b0-13)	0.00 Hz	
d5-08	Multi-point V/F voltage 3 (V3)	0.0%~100.0%	0.0%	
d5-09	V/F slip compensation coefficient	0.0%~200.0%	0.0%	
d5-10	oscillation suppression gain	0~100	0	
d5-12	Voltage source for V/F separation	0: Digital setting(d5-13) 1: AI1 2: AI2 3: AI3 4: Pulse setting(DI6) 5: Multi-function 6: Simple PLC 7: PID 8: Communication setting Note:100.0% corresponds to the rated motor voltage	0	
d5-13	Voltage digital setting for V/F separation	0 V ~ rated motor voltage	0 V	
d5-14	Voltage rise time of V/F separation	0.0s~1000.0s Note: It indicates the time for the voltage rising from 0 V ~ rated motor voltage.	0.0s	
Group d6: Control Optimization Parameters				
d6-00	Carrier frequency	0.5kHz~15.0 kHz	Model dependent	
d6-01	DPWM switchover frequency upper limit	0.00Hz~15.00 Hz	12.00 Hz	
d6-02	PWM modulation mode	0: Asynchronous modulation 1: Synchronous modulation	0	
d6-03	Carrier frequency adjustment with temperature	0: No 1: Yes	1	
d6-04	Random PWM depth	0: Random PWM invalid 1~10: Random PWM carrier frequency depth	0	

Code	Parameter Name	Setting range	Default	Property
d6-05	Dead zone compensation mode selection	0: No compensation 1: Compensation mode 1 2: Compensation mode 2	1	
d6-06	SVC mode selection	0: SVC mode 0 1: SVC mode 1	1	
d6-07	Flux braking gain	0~150%	100%	
d6-08	Flux compensation gain	0~200% (Default value is 100%)	100%	
d6-09	Flux compensation cut-off frequency	0.00Hz~50.00Hz	20.00Hz	
d6-10	Excitation current loop KP	0~500	100	
d6-11	Torque current loop KP	0~500	0	
d6-12	Torque current filtering time coefficient	0~31	28	
d6-13	No load current boost	0.0%~50.0%	10.0%	
d6-14	Cut-off frequency for no load current boost	0.00Hz~20.00Hz	15.00Hz	
d6-15	Field weakening gain	50%~150%	100%	
Group U0: Standard Monitoring Parameters				
U0-00	Running frequency	0.00~300.00 Hz (b0-11 = 2)	-	●
U0-01	Setting frequency	0.00~3000.0 Hz (b0-11 = 1)	-	●
U0-02	DC Bus voltage	0.0~3000.0 V	-	●
U0-03	Output voltage	0V~1140 V	-	●
U0-04	Output current	0.00A~655.35 A (Frequency inverter power ≤ 55 kW) 0.0A~6553.5 A (Frequency inverter power > 55 kW)	-	●
U0-05	Output power	0~32767	-	●
U0-06	Output torque	-200.0%~200.0%	-	●
U0-07	DI state	-0~32767	-	●
U0-08	DO state	0~1023	-	●
U0-09	AI1 voltage	-	-	●
U0-10	AI2 voltage	-	-	●
U0-11	AI3 voltage	-	-	●
U0-12	Count value	-	-	●
U0-13	Length value	-	-	●
U0-14	Load speed display	0~65535	-	●
U0-15	PID setting	0~65535	-	●
U0-16	PID feedback	0~65535	-	●
U0-17	PLC stage	-	-	●
U0-18	Input pulse frequency	0.00kHz ~100.00 kHz	-	●
U0-19	Feedback speed, unit:0.01Hz	-3000.0Hz~3000.0 Hz -300.00Hz~300.00 Hz	-	●
U0-20	Remaining running time	0.0min~6500.0 min	-	●
U0-21	AI1 voltage before correction	0.00V~10.57 V	-	●

Code	Parameter Name	Setting range	Default	Property
U0-22	AI2 voltage before correction	0.00V~10.57 V	-	●
U0-23	AI3 voltage before correction	-10.57V~10.57 V	-	●
U0-24	Linear speed	0.0min~65535m/min	-	●
U0-25	Present power-on time	-	-	●
U0-26	Present running time	-	-	●
U0-27	Communication setting value	-100.00%~100.00%	-	●
U0-28	Encoder feedback speed	-3000.0Hz~3000.0 Hz -300.00Hz~300.00 Hz	-	●
U0-29	Main frequency X	0.00Hz~300.00 Hz 0.0Hz~3000.0 Hz	-	●
U0-30	Auxiliary frequency Y	0.00Hz~300.00 Hz 0.0Hz~3000.0 Hz	-	●
U0-31	Viewing any register address value	0°C~200°C	-	●
U0-32	Synchronous motor rotor position	0.0°~ 359.9°	-	●
U0-33	Motor temperature	0°C~200°C	-	●
U0-34	Target torque	-200.0%~200.0%	-	●
U0-35	Resolver position	0~4095	-	●
U0-36	Power factor angle	-	-	●
U0-37	ABZ position	0~65535	-	●
U0-38	Target voltage of V/F separation	0 V ~ rated motor voltage	-	●
U0-39	Output voltage of V/F separation	0 V ~ rated motor voltage	-	●
U0-40	DI input state visual display	-	-	●
U0-41	DO output state visual display	-	-	●
U0-42	DI function state visual display 1	-	-	●
U0-43	DO function state visual display	-	-	●
U0-44	Fault information	-	-	●
U0-45	Phase Z signal counting	-	-	●
U0-46	Present setting frequency (%)	-100.00%~100.00%	-	●
U0-47	Present running frequency (%)	-100.00%~100.00%	-	●
U0-48	Frequency inverter running state	0~65535	-	●
U0-49	Sent value of point-point communication	-100.00%~100.00%	-	●

Code	Parameter Name	Setting range	Default	Property
U0-50	Received value of point-point communication	-100.00%~100.00%	-	●
Group A0: System Parameters				
A0-00	User password	0~65535	0	
A0-01	Product number	Frequency inverter product number	Model dependent	●
A0-02	Software version	Software version of control board	Model dependent	●
A0-03	Rated current	-	Model dependent	●
A0-04	Rated voltage	-	Model dependent	●
A0-07	Parameter modification property	0: Modifiable 1: Not modifiable	0	
A0-08	Individualized parameter display property	Unit's digit: User-defined parameter QUICK display selection. 0: Not display 1: Display Ten's digit: User-changed parameter QUICK display selection. 0: Not display 1: Display	0	
A0-09	Restore default settings	0: No operation 1: Restore default settings except motor parameters and accumulation record. 2: Restore default settings for all parameters 3: Reserve 4: Clear records Other: Reserve	0	
Group A1: User-defined Parameters				
A1-00	User-defined function code 0	User visible function codes	ub0.01	
A1-01	User-defined function code 1	User visible function codes	ub0.02	
A1-02	User-defined function code 2	User visible function codes	ub0.03	
A1-03	User-defined function code 3	User visible function codes	ub0.07	
A1-04	User-defined function code 4	User visible function codes	ub0.12	
A1-05	User-defined function code 5	User visible function codes	ub0.21	
A1-06	User-defined function code 6	User visible function codes	ub0.22	
A1-07	User-defined function code 7	User visible function codes	ub3.00	

Code	Parameter Name	Setting range	Default	Property
A1-08	User-defined function code 8	User visible function codes	ub3.01	
A1-09	User-defined function code 9	User visible function codes	ub3.02	
A1-10	User-defined function code 10	User visible function codes	ub4.04	
A1-11	User-defined function code 11	User visible function codes	ub6.01	
A1-12	User-defined function code 12	User visible function codes	ub1.00	
A1-13	User-defined function code 13	User visible function codes	ub1.10	
A1-14	User-defined function code 14	User visible function codes	ud2.00	
A1-15	User-defined function code 15	User visible function codes	ud2.01	
A1-16	User-defined function code 16	User visible function codes	uA0.00	
A1-17	User-defined function code 17	User visible function codes	uA0.00	
A1-18	User-defined function code 18	User visible function codes	uA0.00	
A1-19	User-defined function code 19	User visible function codes	uA0.00	
A1-20	User-defined function code 20	User visible function codes	uA0.00	
A1-21	User-defined function code 21	User visible function codes	uA0.00	
A1-22	User-defined function code 22	User visible function codes	uA0.00	
A1-23	User-defined function code 23	User visible function codes	uA0.00	
A1-24	User-defined function code 24	User visible function codes	uA0.00	
A1-25	User-defined function code 25	User visible function codes	uA0.00	
A1-26	User-defined function code 26	User visible function codes	uA0.00	
A1-27	User-defined function code 27	User visible function codes	uA0.00	
A1-28	User-defined function code 28	User visible function codes	uA0.00	
A1-29	User-defined function code 29	User visible function codes	uA0.00	
A1-30	User-defined function code 30	User visible function codes	uA0.00	
A1-31	User-defined function code 31	User visible function codes	uA0.00	

Warranty Agreement

- The warranty period of the product is 12 months (refer to the barcode of nameplate). During the warranty period, if the product fails or is damaged under the condition of normal use by following the instructions, EMHEATER will be responsible for free maintenance.
- Within the warranty period, maintenance will be charged for the damages caused by the following reasons:
 - Improper use or repair/modification without prior permission;
 - Fire, flood, abnormal voltage, other disasters and secondary disaster;
 - Hardware damage caused by dropping or transportation after procurement;
 - Improper operation;
 - Trouble out of the frequency inverter (for example, external device).
- If there is any failure or damage to the product, please correctly fill out the **Product Warranty Card** in detail.
- The maintenance fee is charged according to the latest Maintenance Price List of EMHEATER.
- The Product Warranty Card is not re-issued. Please keep the card and present it to the maintenance personnel when asking for maintenance.
- If there is any problem during the service, contact EMHEATER's agent or EMHEATER directly.
- This agreement shall be interpreted by China EM Technology Limited.

Product Warranty Card		
Customer Information	Company address:	
	Company Name:	Contact Person:
	Post Code:	Tel:
Product information	Product model:	
	Body barcode (Attach here):	
	Name of agent:	
Failure information	(Maintenance time and content):	
Maintenance personnel:		