

ENC

ISO Quality Management System Authentication



EN500 series inverter Ver. 1.0

Service Manual

SHENZHEN ENCOM ELECTRIC TECHNOLOGIES CO.,LTD.

Foreword

Encom products are designed and produced according to EN61800-5-1: 2007, EN61010-1:2010, EN61800-3: 2004+A1:2012 standards under ISO9001:2008 quality management system.

Thank you for purchasing EN500 series inverter from Shenzhen Encom Electric Technologies CO., LTD.

EN500 series which is multifunctional and general vector inverter can fulfill all kinds of demand for general-purpose inverter by advanced control manner which make high torque, high precision and wide-range speed regulation drive be available. EN500 is organic combine of customer's general need and industrial requirement to provide practical PID adjuster, simple PLC, textile traverse programmable input output terminal control, impulse frequency provision, internal Modbus, can bus, profibus, 485free agreement and other special function and platform for customers and to provide highly-integrated incorporative solution of high value for reducing system cost and improving system reliability for device manufacturing and automation engineering customers. EN500 series has inside input phase-missing, output phase-missing, shorted-to-ground and other protection method, which improve the reliability and safety.

This manual provides the clients with the installation and wiring, parameter setting, malfunction solving, daily maintenance and other instructions. To make sure to install right, operate the inverter reasonably and employ its advantage. Please read this manual carefully before installation, and please keep them well to the terminal users of inverter.

Please contact our office or dealer in all places at any moment if you have any doubts or special demands when using these inverters, and you can also contact our after service center in our Headquarters directly. We will serve you with all our heart.

We reserve our right to notice you if we change contents of this manual.

Welcome to choose other inverters of our company:

- EDS800 series mini inverter**
- EN600 series high performance flux vector control inverter**

Content

1	Safety information and use notice points	1
1.1	Safety precautions	1
1.2	Use range	3
1.3	Use notice points	3
1.4	Scrap notice points	5
2	Type and specification of the inverter	6
2.1	Incoming inverter inspect	6
2.2	Type explanation	6
2.3	Nameplate explanation	6
2.4	Series type explanation	7
2.5	Appearance and parts name explanation	7
2.6	Outer size	8
2.7	Accessories base	9
2.7.1	Converter and base corresponding relational tables	9
2.7.2	Base dimension	9
2.8	Outer size of keypad and its fixing box	11
2.9	Product technic index and spec	11
3	Installation and wiring	14
3.1	Installation ambient	14
3.1.1	The demands for installation ambient	14
3.1.2	Installation direction and space	14
3.2	Parts dis-assembly and installation	15
3.2.1	Metal cover key board dis-assembly and installation	15
3.2.2	Cover dis-assembly and installation	16
3.3	Wiring notice points	17
3.4	Main loop terminal wiring	18
3.4.1	Connection between inverter and fitting parts	19
3.4.2	Main loop terminal wiring	20
3.5	Basic running wiring diagram	21
3.6	Control loop collocation and wiring	22

3.6.1	Location&function of terminal and slide switch:	22
3.6.2	Descriptions for control CPU board	24
3.6.3	Analog input&output terminal wiring	26
3.6.4	Digital input terminal wiring	27
3.6.5	The communication terminal wiring	29
4	EMC Electromagnetic Compatibility Explanation	30
4.1	Restraining to noise disturbance	30
4.1.1	Type of disturbance noise	30
4.1.2	Noise spread road	31
4.1.3	Basic countermeasure for suppressing disturbance	31
4.2	Local wiring and earthing	32
4.3	Leak current and countermeasure	33
4.4	Installation demand for electromagnetic on-off electronic device.....	33
4.5	Noise filter installation instructions	34
5	Run and operation explanation for inverter	35
5.1	Run of inverter	35
5.1.1	Running order channels	35
5.1.2	Frequency-provision channel.....	35
5.1.3	Work state	36
5.1.4	Run mode	37
5.2	Operation and use of key board	39
5.2.1	Keypad layout	39
5.2.2	Keypad function description	39
5.2.3	LED and indicator light	40
5.2.4	Key board display status	40
5.2.5	User Management Parameters	43
5.2.6	Method for operating keypad.....	43
5.3	Inverter electrification	46
5.3.1	Check before electrification	46
5.3.2	First electrification	47

6	Function parameter schedule graph	48
6.1	Symbol description	48
6.2	Function parameter schedule graph	48
7	Detailed Function Specification	87
7.1	System Parameter Group:F00	87
7.2	Basic Run Function Parameter Group:F01	95
7.3	Start, stop, forward/reverse, brake function parameter group: F02.....	104
7.4	V/F control parameter group: F03.....	110
7.5	Auxiliary running parameter group: F04	113
7.6	Communication control parameter group: F05.....	119
7.7	Setting curve parameter group: F06	123
7.8	Analog quantity, Pulse input function parameter group: F07.....	127
7.9	On-off input function parameter group: F08.....	130
7.10	Switch output function parameter group: F9	146
7.11	Simply PLC/multi-step speed function parameters group:F10	157
7.12	Closed-loop control parameters Group :F11	164
7.13	Constant pressure water supply function parameters Group:F12	171
7.14	Traverse Operating Parameters :Group F13	174
7.15	Velocity Control Parameter Group:F14	178
7.16	Asynchronous Motor Parameter Group:F15	179
7.17	Reserved Parameter Group 1: F16.....	181
7.18	Reserved Parameter Group 2: F17.....	181
7.19	Enhance Control Parameter Group:F18	182
7.20	Protective Relevant Function Parameter Group: F19	185
7.21	Internal Virtual Input Output Node Parameter Group:F20.....	195
7.22	Reserved parameter group 3: F21	198
7.23	Reserved parameter group 4: F22	198



7.24	Reserved parameter group 5: F23	198
7.25	Reserved parameter group 6: F24	198
7.26	User Definition Display Parameter Group:F25	199
7.27	Fault Record Function Parameter Group:F26	201
7.28	Password and Manufacturer Function Parameter Group:F27	203
8	Troubleshooting	204
8.1	Failure and countermeasure	204
8.2	Failure record lookup	208
8.3	Failure reset	209
8.4	Alarm reset	209
9	Maintenance	210
9.1	Routine maintenance	210
9.2	Inspection and replacement of damageable parts	210
9.3	Repair guarantee	211
9.4	Storage	212
10	Modbus communication protocol	213

1 Safety information and use notice points

In order to ensure the safety of your personal and equipment, before using the inverter, please read this chapter of contents conscientiously.

1.1 Safety precautions

There are three kinds of safe relevant warnings in this service manual, they are as follows:

symbol	symbol description
	If do not operate on request, may cause death, severely injured or serious property loss.
	If do not operate on request, may make the body injured or the equipment damaged.
 note	This symbol is briefed on some useful information.



Forbid user directly power off when the inverter is under running, accelerating or decelerating. Must first ensure that the drive has been completely shut down and in standby situation, then you can perform power-off operation. Otherwise, the users themselves bear the damage of the inverter, equipment and personal accident.



- (1) Forbid to connect U, V, W output end to AC power supply, otherwise cause the complete damage of the inverter.**
- (2) Don't make P- and P + short-circuited, otherwise cause the inverter to be damaged and the power of short circuit.**
- (3) The inverter is forbidden to install on the flammables, otherwise have danger of fire.**
- (4) Don't install it in the environment with explosive gas, otherwise have danger of causing explosion.**
- (5) After connecting main loop, should carry on insulating treatment to bare wiring end, otherwise have danger of getting an electric shock.**
- (6) If being connected to the power supply, don't operate the inverter with moist hands, otherwise have danger of getting an electric shock.**
- (7) The ground terminal of the inverter must be grounded well.**
- (8) Inverter being connected to power supply, please don't open cover and carry on wiring, can connect the wire or check only after closing power for 10 minutes.**
- (9) Only qualified personnel may carry on wiring and forbid leaving over any conductive thing in machine, otherwise have danger of getting an electric shock or causing damage of the inverter.**
- (10) Inverter stored for over 6 months, should be stepped up gradually with voltage regulator first while having the electricity, and keep the standby mode for 1 hour, otherwise have danger of getting electric shock and explosion.**



- (1) It is prohibited that connect AC 220V/380V signal to control ends except TA,TB,TC, otherwise have the inverter's completely damaged.**
- (2) If the inverter is damaged or without all parts, please don't install and operate it, otherwise have danger of fire or cause person be injured.**
- (3) When installing, should choose a place where can endure the inverter, otherwise have danger of injuring personnel or damaging property while falling down.**

1.2 Use range

- (1) This inverter is only suitable for three phases AC asynchronous motor in general industrial field.
- (2) While applying inverter to such equipments that relate much to the life, great property, safety devices etc., must handle cautiously, and consult with producer, please.
- (3) This inverter belongs to the control device of general industrial motor, if used in dangerous equipment, must consider the security safeguard procedures when the inverter breaks down.

1.3 Use notice points

- (1) EN500 series inverter is voltage-type inverter, so temperature, noise and vibration slightly increasing compared to power source running when using, belongs to normal phenomenon.
- (2) If need to run for a long time with constant torque of low-speed, must select motor of frequency conversion for use. Use general asynchronous AC motor when running at a low speed, should control temperature of the motor or carry on heat dissipation measure forcedly, so as not to burn the generator.
- (3) Such mechanical device needing lubricating as the gearbox and gear wheel, etc., after running at a low speed for a long time, may be damaged as lubrication result become poor, please take necessary measure in advance.
- (4) When the motor running with frequency above specified, besides considering the vibration, noise increase of the motor, must also confirm speed range of the motor bearing and the mechanical device.
- (5) For hoist and great inertia load, etc., the inverter would shut off frequently due to over-current or over-voltage failure, in order to guarantee normal work, should consider choosing proper brake package.
- (6) Should switch on/off the inverter through terminal or other normal order

channels. It is prohibited that switch on/off the inverter frequently by using strong electric switch such as magnetic control conductor, otherwise will cause the equipment to be damaged.

- (7) If need to install such switch as the magnetic control conductor, etc. between inverter output and the motor, please guarantee the inverter is switched on/off without output, otherwise may damage the inverter.
- (8) The inverter may meet with mechanical resonance of the load within certain range of frequency output, can set up jumping frequency to evade.
- (9) Before using, should confirm the voltage of the power is within the working voltage range allowed, otherwise should vary voltage or order special inverter.
- (10) In the condition of altitude above 1000 meters, should use the inverter in lower volume, reduce output current by 10% of specified current after each 1000 meters height increasing.
- (11) Should make insulation check to the motor before using it for the first time or after a long time placement. Please inspect with 500V voltage-type megohm meter according to method shown as graph 1-1 and insulation resistance should not be smaller than $5\text{ M}\Omega$, otherwise inverter may be damaged.
- (12) To forbid assembling capacitor for improving power factor or lightningproof voltage-sensible resistance etc., otherwise will cause malfunction trip of the inverter or damage of the parts, shown as Fig. 1-2.

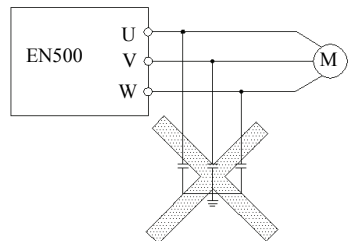
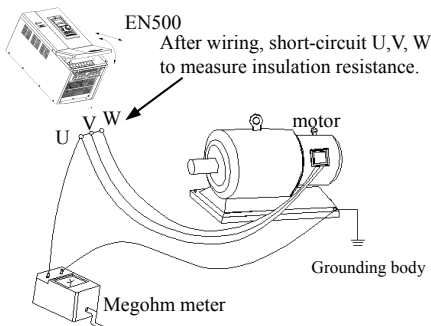

Fig.1-1 motor insulation measure **Fig.1-2 capacitor at output side forbidden**

1.4 Scrap notice points

When disposing scrap inverter and its parts, please note:

- (1) The unit: please discard as industrial useless.
- (2) Electrolytic capacitor: when burning the inverter electrolytic capacitor in it may explode.
- (3) Plastic: when plastic, rubber parts etc. In the inverter are burning, they may bring bad, toxic gas, so please be ready to safeguards.

2 Type and specification of the inverter

2.1 Incoming inverter inspect

- (1) Check if there is damage during transportation and inverter itself has damage or fall-off parts.
- (2) Check if parts presented in packing list are all ready.
- (3) Please confirm rated data of the inverter is in line with your order requirement.

Our product is guaranteed by strict quality system during manufacturing, packing, transportation etc., please contact our company or local agent rapidly if some careless omission or mistake arise, we'll deal with it as soon as possible.

2.2 Type explanation

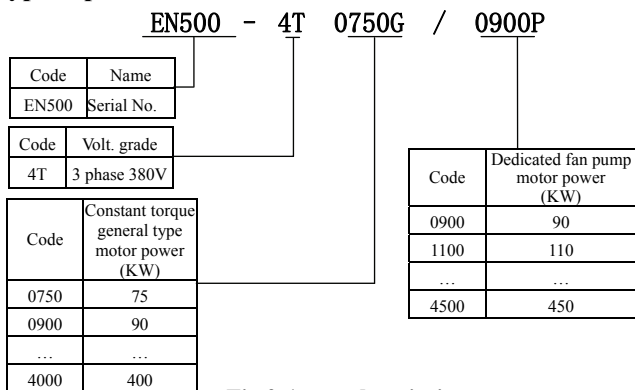

Fig.2-1 type description

2.3 Nameplate explanation

Nameplate presented as figure 2-2 with type and rating data at the bottom of inverter right side.

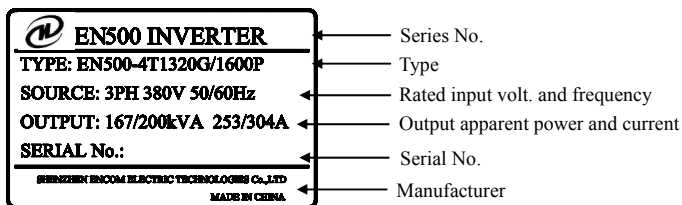

Fig.2-2 Nameplate

2.4 Series type explanation

Input Voltage	Inverter type	Rate power (KVA)	Rated output Current(A)	Adaptable motor (KW)
3 phase 380V	EN500-4T0750G/0900P	99/116	150/176	75/90
	EN500-4T0900G/1100P	116/138	176/210	90/110
	EN500-4T1100G/1320P	138/167	210/253	110/132
	EN500-4T1320G/1600P	167/200	253/304	132/160
	EN500-4T1600G/2000P	200/250	304/380	160/200
	EN500-4T2000G/2200P	250/280	380/426	200/220
	EN500-4T2200G/2500P	280/318	426/474	220/250
	EN500-4T2500G/2800P	318/342	474/520	250/280
	EN500-4T2800G/3150P	342/390	520/600	280/315
	EN500-4T3150G/3550P	390/430	600/650	315/355
	EN500-4T3550G/3750P	430/447	650/680	355/375
	EN500-4T3750G/4000P	447/493	680/750	375/400
EN500-4T4000G/4500P	493/540	750/800	400/450	

2.5 Appearance and parts name explanation

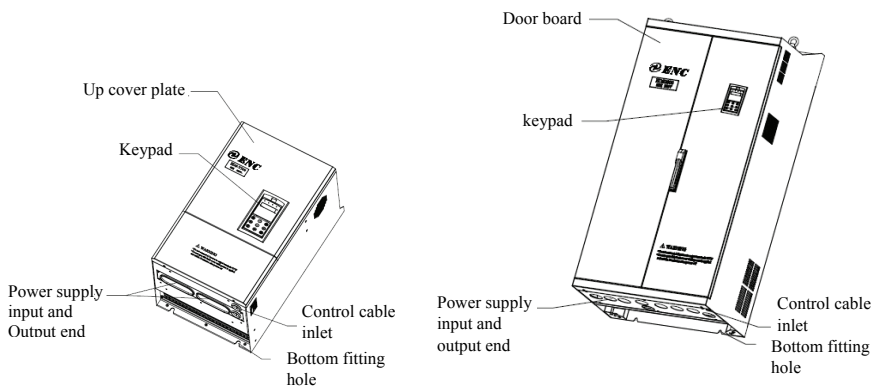

Fig.2-3 Parts name sketch

2.6 Outer size

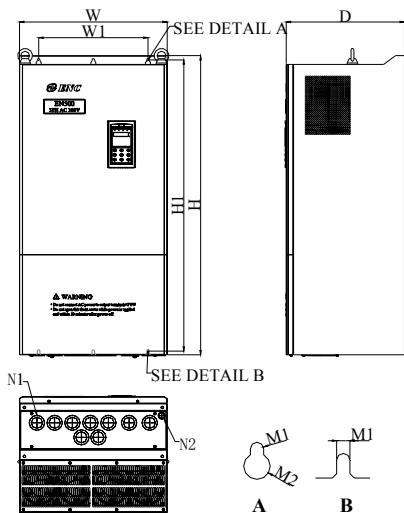

Fig. a

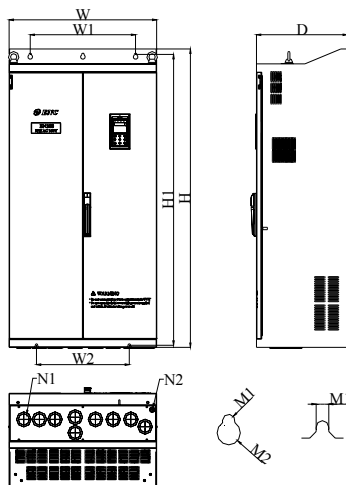

Fig. b

Fig.2-4 outer dimension

Table 2-2 mounting size

Inverter type	H (mm)	H1 (mm)	W (mm)	W1 (mm)	W2 (mm)	D (mm)	N1 (mm)	N2 (mm)	M1 (mm)	M2 (mm)	Fig.
EN500-4T0750G/0900P	570	546	340	237	-	320	-	-	Φ12	Φ18	Fig.a
EN500-4T0900G/1100P											
EN500-4T1100G/1320P											
EN500-4T1320G/1600P	650	628	400	297	-	340	-	-	Φ12	Φ18	
EN500-4T1600G/2000P											
EN500-4T2000G/2200P											
EN500-4T2200G/2500P	1030	1003	500	370	-	400	Φ38	Φ19	Φ9	Φ18	
EN500-4T2500G/2800P											
EN500-4T2800G/3150P											
EN500-4T3150G/3550P	1368	1322	700	500	440	430	Φ52	Φ19	Φ12	Φ22	Fig.b
EN500-4T3550G/3750P											
EN500-4T3750G/4000P											
EN500-4T4000G/4500P	1518	1483	700	500	500	430	OB 77*47	Φ19	Φ12	Φ22	

2.7 Accessories base

2.7.1 Converter and base corresponding relational tables

Inverter type	Base type			
	Standard base	With input reactor	With output reactor	With DC reactor
EN500-4T0750G/0900P	SP-BS-0900	SP-BS-0750-LI	SP-BS-0900-LO	SP-BS-0750-LD
EN500-4T0900G/1100P		SP-BS-0900-LI	SP-BS-0900-LO	-
EN500-4T1100G/1320P	SP-BS-1320	SP-BS-1100-LI	SP-BS-1100-LO	-
EN500-4T1320G/1600P		SP-BS-1320-LI	SP-BS-1320-LO	-
EN500-4T1600G/2000P	SP-BS-1600	SP-BS-1600-LI	SP-BS-1600-LO	-
EN500-4T2000G/2200P	SP-BS-2200	SP-BS-2000-LI	SP-BS-2000-LO	-
EN500-4T2200G/2500P		SP-BS-2200-LI	SP-BS-2200-LO	-
EN500-4T2500G/2800P	SP-BS-4000	SP-BS-2500-LI	SP-BS-2500-LO	-
EN500-4T2800G/3150P		SP-BS-2800-LI	SP-BS-2800-LO	-
EN500-4T3150G/3550P		SP-BS-3150-LI	SP-BS-3150-LO	-
EN500-4T3550G/3750P		SP-BS-4000-LI	SP-BS-4000-LO	-
EN500-4T3750G/4000P		SP-BS-4000-LI	SP-BS-4000-LO	-
EN500-4T4000G/4500P		SP-BS-4000-LI	SP-BS-4000-LO	-

2.7.2 Base dimension

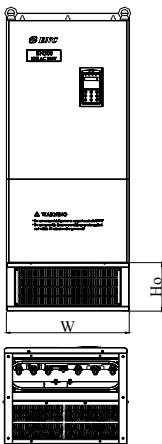

Fig.a

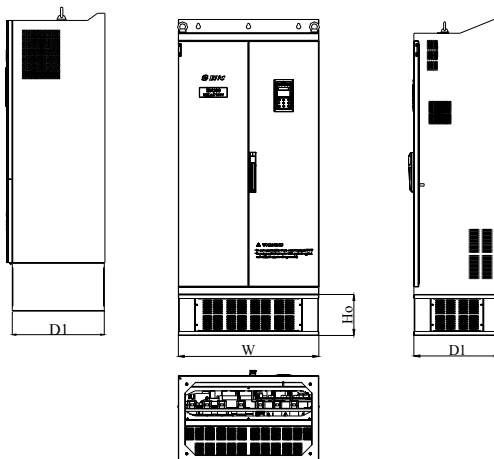

Fig.b

Fig.2-5 base figure shape

Table 2-2 base size

Base type	W (mm)	D1 (mm)	Ho (mm)	Explanatory chart
SP-BS-0900	340	300	180	Fig.a
SP-BS-0750-LI	340	300	350	
SP-BS-0750-LD				
SP-BS-0900-LI				
SP-BS-0900-LO				
SP-BS-1320				
SP-BS-1100-LI	400	320	380	
SP-BS-1100-LO				
SP-BS-1320-LI				
SP-BS-1320-LO				
SP-BS-1600	480	380	180	
SP-BS-1600-LI	480	380	400	
SP-BS-1600-LO				
SP-BS-2200	500	380	200	
SP-BS-2000-LI	500	380	400	
SP-BS-2000-LO				
SP-BS-2200-LI				
SP-BS-2200-LO				
SP-BS-4000	700	430	204	Fig.b
SP-BS-2500-LI	700	430	400	
SP-BS-2500-LO				
SP-BS-2800-LI				
SP-BS-2800-LO				
SP-BS-3150-LI				
SP-BS-3150-LO				
SP-BS-4000-LI	700	430	450	
SP-BS-4000-LO				

2.8 Outer size of keypad and its fixing box(unit: mm)

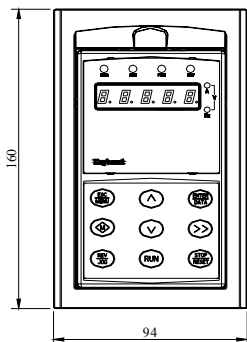

Fig.2-5 Mounting size of KB25 keypad

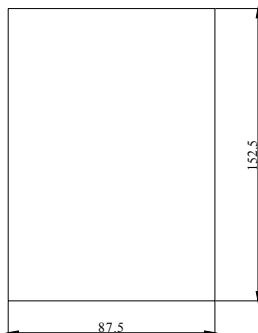
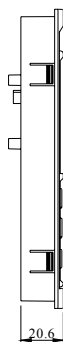

Fig.2-6 Hole size of KB25 keypad

2.9 Product technic index and spec

Item		Item description	
Input	Rating volt.,frequency	3 phase 380V:50Hz /60Hz	
	Allowed volt. range	320~460V	
Output	Voltage	0~380V	
	Frequency	0~650Hz	
	Overload capacity	Gtype: 150% of rated current for 1 minute ; Ptype: 120% of rated current for 1 minute.	
Control performance	Control mode	speed sensorless vector control, open loop V/F control	
	Speed regulation range	1: 100	
	Start-up torque	150% of rated torque at 5Hz frequency	
	Running speed stable state precision	$\leq \pm 0.5\%$ of rating synchronous speed	
	Frequency precision	Digital setting: max. frequency $x \pm 0.01\%$ Analog setting: max. frequency $x \pm 0.5\%$	
	Frequency resolution	Analog setting	0.1% of max. frequency
		Digital setting	The precision less than 100HZ: 0.01Hz
Exterior impulse		0.1% of max. frequency	
Torque boost		Automatic torque boost, manual torque boost 0.1~12.0%	

	V/F curve(volt. frequency characteristic)	Set rating frequency randomly at range of 5~650Hz,can choose constant torque, degressive torque 1,degressive torque 2,degressive torque 3,user defined V/F curve in total 5 kinds of curve
	Acceleration and deceleration curves	2 modes: linear acceleration and deceleration and "S" acceleration and deceleration; 15 types of acceleration and deceleration time, the time unit is optional(0.01s,0.1s,1s), the max is 1000 minutes
	Brake	Power consumption brake The brake unit can be connected externally between P+ and P- when it is necessary
		DC brake Optional start-up and stop,action frequency 0~15Hz,action current 0~100%,action time 0~30.0s
	Jog	JOG frequency range: 0.00-upper limiting frequency JOG acceleration/deceleration time: 0.0-6000.0s
	Multisection speed running	Multisection speed operation can be achieved by interior PLC or control terminal. As many as 15sections, which has their own acceleration and deceleration time. The interior PLC supports power down save.
	Interior PID controller	It realizes process-controlled closed loop control system easily.
	Automatic energy-saving operation	Optimize automatically V/F curve base on condition of loading, achieving energy-saving operation.
	Automatic voltage regulate(AVR)	It can keep constant output voltage automatically when the mains voltage changes.
	Automatic current limiting	The current is limited automatically during the running process so as to avoid frequent tripping due to over-current.
	carrier modulation	The carrier frequency is automatically adjusted based on the load features.
	Speed tracking restart	Make the rotating motor smooth start without shocking
Running function	Running order specified channel	Keypad setting, control terminal setting, communication setting, which can be changed by many ways.
	Running frequency specified channel	Main and complement setting realizing a main adjustment and fine tuning control. Digital setting , analog setting , impulse setting , pulse-width setting , communication setting and other settings can be switch freely
	Binding function	Running order channel and frequency setting channel can be bond optionally, change synchronously
Input and Output character	Digital input terminal	8 digital input (DI) terminals , the max frequency is 1KHZ, one of which support up to 50KHz. The digital terminal can be expanded to 14 terminals.
	Analog input terminal	2 analog input (AI) terminal, AI1 can choose 4~20mA or 0~10V as output, AI2 is differential input, 4~20mA or -10~10V input is available.The analog terminal can be expanded to 4 terminals
	Pulse output terminal	Impulse square wave signal output of 0~20KHZ, can realize output of physical quantity such as setting frequency,output frequency etc.

	Analog output terminal	2 analog signal output terminal, AO1 can be 4~20mA or 0~10V, AO2 can be 4~20mA or 0~10V; through them the inverter can realize output of physical quantity such as setting frequency, output frequency etc. And can be expanded to 4 channel output. This output analog terminal can be expanded to 4 terminals
Unique feature	Rapid current limiting	Limit inverter over current to the greatest degree, making it running reliably
	Monopulse control	Suitable for the inverter with one key that controls the inverter on or off, which is simple and reliable to operate.
	Fixed length control	Can realize fixed length control
	Timing control	Time range: 0.0~6500.0 minutes
	Virtual I/Os	5 groups virtual input, output IO, can realize simply logical control
keypad	LED display	The parameters like setting frequency, output frequency, output voltage, output current can be displayed
	Lock the button	Lock all or part of the buttons.
	Protection function	Motor short-circuit detection at power-on, input/output phase loss protection, overcurrent protection, overvoltage protection, undervoltage protection, overheat protection and overload protection, relay protection, terminal protection and non stop protection when power off.
Ambient	Use ambient	Indoor, free from direct sunlight, dust, corrosive gas, combustible gas, oil smoke, vapour, drip or salt.
	Altitude	Less than 1000 meters. (increase every 1000m above 1000m, derate 10%)
	Ambient temperature	-10℃ ~ +40℃(under ambient temperature 40℃ ~ 50℃, please reduce the volume or strengthen heat sink)
	Ambient humidity	Less than 95%RH, without condenses
	vibration	Smaller than 5.9m/s ² (0.6g)
	Storage temperature	-40℃ ~ +70℃
Structure	Protection level	IP20
	Cooling mode	Forced air cooling and natural
	Mounting mode	Wall hanging and cabinet installation



note

To exert excellent performance of this inverter, please choose correct type and check relevant content according to this chapter before wiring for use.



Must choose correct type, otherwise may cause abnormal running of the motor or damage of the inverter.

3 Installation and wiring

3.1 Installation ambient

3.1.1 The demands for installation ambient

- (1) Installed in drafty indoor place, the ambient temperature should be within $-10^{\circ}\text{C}\sim 40^{\circ}\text{C}$, it needs external compulsory heat sink or reduce the volume if temperature is over than 40°C .
- (2) Avoid installing in places with direct sunlight, much dust, floating fiber and metal powder.
- (3) Don't install in place with corrosive, explosive gas.
- (4) The humidity should be smaller than 95%RH, without condensation water.
- (5) Installed in place of plane fixing vibration smaller than $5.9\text{m/s}^2(0.6\text{g})$.
- (6) Keep away from electromagnetic disturbance source and other electronic apparatus sensible to electromagnetic disturbance.

3.1.2 Installation direction and space

- (1) Normally the inverter should be mounted vertically, horizontal mounting will seriously affect heat dissipation and the inverter must be used in lower volume.
- (2) Demand for minimum mounting space and distance, please see Fig.3-1.
- (3) When installing multiple inverters up and down, leading divider must be applied between them, see Fig. 3-2.

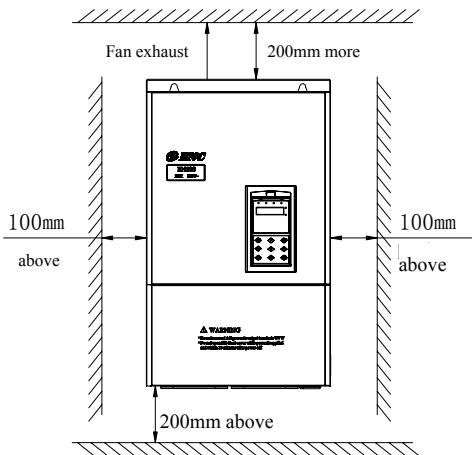

Fig. 3-1 mounting space

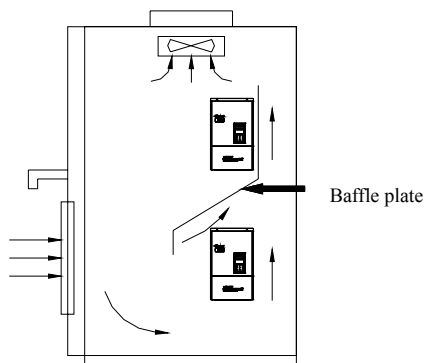

Fig. 3-2 mounting of multiple inverters

3.2 Parts dis-assembly and installation

3.2.1 Metal cover key board dis-assembly and installation

(1) Dis-assembly

Let the forefinger press finger inlet on the keypad, depress fixing flexible plate on the top lightly, draw it outward, then you can disassemble the keypad, see fig. 3-3.

(2) Assembly

First place the keypad lightly in the open hole of the metal cover. When proper position, press fixing flexible plate on top of keypad and then push it inside, release it in proper location(after a crisp sound), see Fig. 3-4.

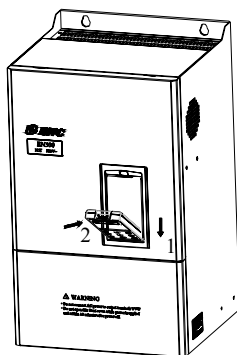
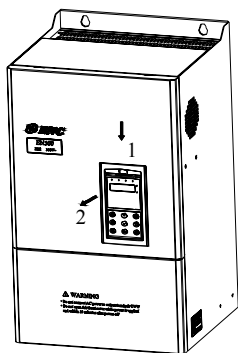

Fig. 3-3 dis-assembly sketch of keypad Fig. 3-4 assembly sketch of keypad

3.2.2 Cover dis-assembly and installation

3.2.2.1 Metal cover dis-assembly and installation:

(1) Dis-assembly

First take off 2 screws at the side of the cover and move it a bit outward horizontally, then tilt it at 15 degree and draw it outward at the direction shown in right figure, now you can take the cover off.

(2) Assembly

First put down the cover in parallel with unit body and make it just locked at two sides of the inverter, secondly force it ahead and make fixing part on its top inserted into fixing slot of unit body, at last screw the cover and finish assembly for the cover. As shown in Fig.3-5.

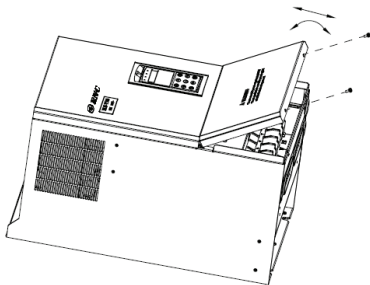

Fig.3-5 Dis-assembly and mounting sketch of metal cover

3.3 Wiring notice points



- (1) Assure power be cut off completely for above 10 minutes before wiring, otherwise there is danger of getting electric shock.
- (2) Forbid connecting power wire to output U, V, W of the inverter.
- (3) There is current leakage inside the inverter. For safety, inverter and motor must be earthed safely, whose requirements can be seen in the No.8 of chapter 3.4.1
- (4) Before shipment compression resistance test of the inverter is passed, so users should not conduct compression resistance test again.
- (5) Do not assemble electromagnetic contactor and absorbing capacitance or other absorbing device. If magnetic control and other switching elements are needed, please make sure the inverter is suspended without output.
- (6) To be convenient for over current protection of input side and power off maintenance, inverter should be connected to power supply through air switch and magnetic control.
- (7) Glued wire or shielding wire should be applied for the wire of control signal, one shielding layer end hung in the air, the other connected to grounding end PE, connecting wire shorter than 20m.



- (1) Before wiring, assure power supply is cut off completely for 10 minutes and all LED indicator light extinguished.
- (2) Before internal wiring, confirm that DC volt. Between main loop end P+ and P- fall down to below DC36V.
- (3) Wiring can only be done by professional person trained and qualified.
- (4) Before electrification, check if voltage grade of the inverter is in line with that of power supply volt., otherwise will cause person injured and device damaged.

3.4 Main loop terminal wiring

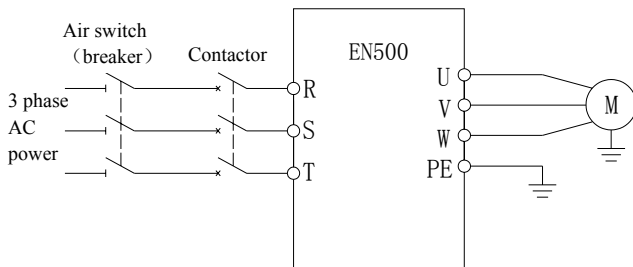

Fig.3-7 main loop simple wiring

For the electronic safety of users, please use the proper air switch at the side of power input. Recommended parameter for breaker and wires can be seen in table.3-1.

Table3-1 recommended parameters for air switch(breaker), contactor and wiring

Types	Air switching or Breaker (A)	contactor (A)	Power input wiring mm ²	Motor output wiring mm ²	Control signal wiring mm ²
EN500-4T0750G/0900P	250	160	95	95	1.5
EN500-4T0900G/1100P	250	160	120	120	1.5
EN500-4T1100G/1320P	350	350	120	120	1.5
EN500-4T1320G/1600P	400	400	150	150	1.5
EN500-4T1600G/2000P	500	400	185	185	1.5
EN500-4T2000G/2200P	600	600	150*2	150*2	1.5
EN500-4T2200G/2500P	600	600	150*2	150*2	1.5
EN500-4T2500G/2800P	800	600	185*2	185*2	1.5
EN500-4T2800G/3150P	800	800	185*2	185*2	1.5
EN500-4T3150G/3550P	800	800	250*2	250*2	1.5
EN500-4T3550G/3750P	800	800	325*2	325*2	1.5
EN500-4T3750G/4000P	1000	1000	325*2	325*2	1.5
EN500-4T4000G/4500P	1000	1000	325*2	325*2	1.5

3.4.1 Connection between inverter and fitting parts

- (1) Must assemble disjunction device such as isolation switch etc. between power source and the inverter to assure personal safety when repairing the inverter and compulsory power off.
- (2) To supply power for loop must have breaker or fuse with over current protection function to avoid malfunction expanding caused by failure of device after.
- (3) AC input reactor
If high-order harmonics between inverter and power supply is strong which can't fulfill system requirement or need to improve input side power factor, AC input reactor is needed.
- (4) Magnetic control conductor only be applied to power supply control and don't apply magnetic control conductor to control on/off of the inverter.

- (5) Input side EMI filter
EMI filter can inhibit high-frequency conduction disturbance and emission disturbance from inverter power supply wire.

- (6) Output side EMI filter
EMI filter can inhibit emission disturbance noise and wire leakage current from output side.

- (7) AC output reactor
Installing AC output reactor is suggested to avoid motor insulation damage, oversize current leakage and inverter frequent protection when connecting wire between inverter and motor exceeds 50m.

- (8) Complete ground wire
Inverter and motor must be earthed and grounding resistor should be smaller than 10Ω. Grounding wire should be short and thick enough. About 3.5mm² of copper wire is needed.

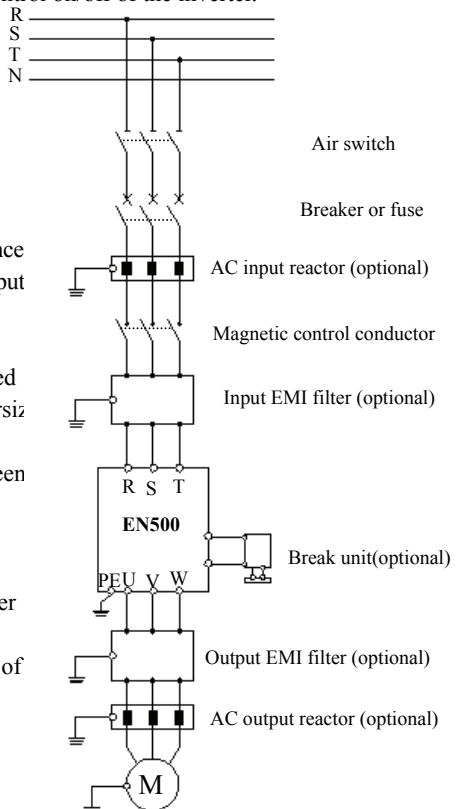

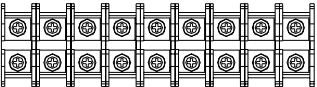
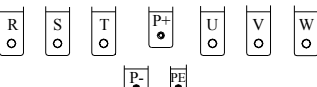
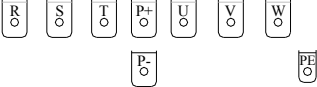

Fig.3-8 connection of inverter and fitting parts

3.4.2 Main loop terminal wiring

For main loop input output terminal, see table 3-2.

Table 3-2 main loop input output terminal description

Adapted type	Main loop terminal	Terminal name	Function description
EN500-4T0750G/0900P		R, S, T	3 phase AC input terminal, connect power
		P+	DC volt. Positive end
		P-	DC volt. Negative end
		P, P+	Reserved terminal for exterior DC reactor
		P+, P-	Reserved terminal for exterior breaker unit
		U, V, W	3 phase AC output terminal, connect power
EN500-4T0900G/1100P ~ EN500-4T1320G/1600P		R, S, T	3 phase AC input terminal, connect power
		P+	DC volt. Positive end
		P-	DC volt. Negative end
		P+, P-	Reserved terminal for exterior breaker unit
		U, V, W	3 phase AC output terminal, connect power
		PE	Grounding terminal
EN500-4T1600G/2000P ~ EN500-4T2200G/2500P		R, S, T	3 phase AC input terminal, connect power
		P+	DC volt. Positive end
		P-	DC volt. Negative end
		P+, P-	Reserved terminal for exterior breaker unit
		U, V, W	3 phase AC output terminal, connect power
		PE	Grounding terminal
EN500-4T2500G/2800P ~ EN500-4T4000G/4500P		R, S, T	3 phase AC input terminal, connect power
		P+	DC volt. Positive end
		P-	DC volt. Negative end
		P+, P-	Reserved terminal for exterior breaker unit
		U, V, W	3 phase AC output terminal, connect power
		PE	Grounding terminal



The wiring of main loop must be right according to the description above. Wrong wiring will cause device damage and people injured.

3.5 Basic running wiring diagram

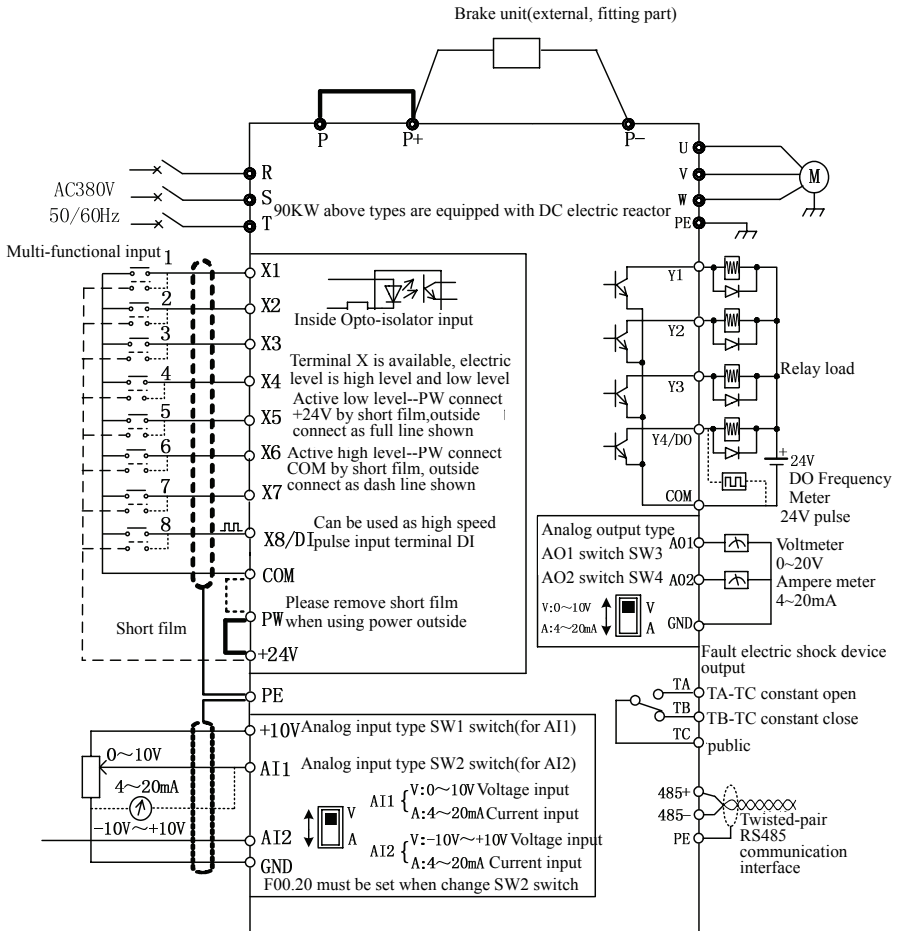

Fig. 3-9 basic wiring diagram

Note: the machine above 90kw has equipped DC electric reactor without P terminal. The 75kw one without electric reactor, please remove Sub copper platoon between P and P+ if external DC reactor is needed.

3.6 Control loop collocation and wiring

3.6.1 Location&function of terminal and slide switch:

For location of terminal and slide switch on the CPU board, please see Fig.3-10.

The terminal CN1 and CN7 are used by the manufacturers. CN2 is extended interface. CN5 is for keypad. The CN3,CN4 and CN6 for users can be seen in table 3-3. The description and function of slide switch consult table3-4. Please read the following descriptions carefully before using inverter.

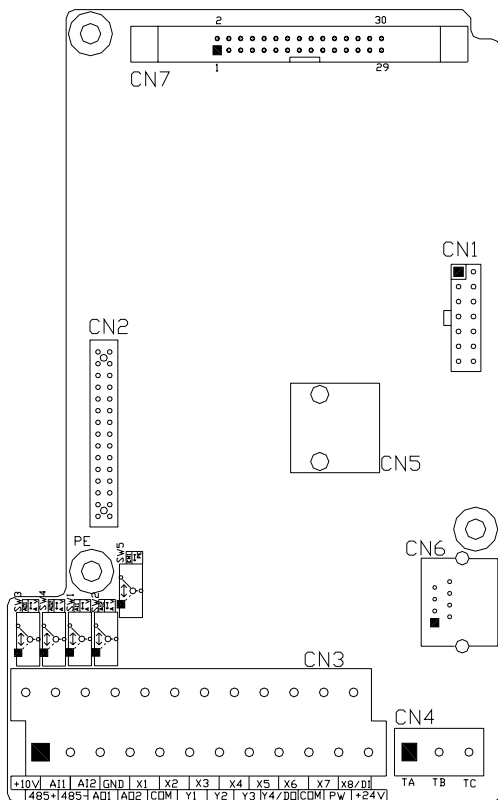









Fig. 3-10 sketch map of CPU board

Table 3-3 function description of terminal provided for user

Order	Function	Description
CN3	Input and output control of external terminal	use when apply external terminal to control inverter running, see 3.6.2
CN4	Signal output of relay	TA-TC is normally open contact ;TB-TC is normally close contact. See 3.6.2
CN6	crystalRS485communication interface	When use 485 communication to realize control, please see Fig.3.6.2

Table 3-4 Slide switch function description for users

Oder	Function	Setting	Default value
SW1	AI1 Analog input signal selection	 V: F00.20 for XXX0 0~+10V voltage signal input  I: F00.20 for XXX1 4~20mA current signal input	F00.20 for 0000 0~+10V
SW2	AI2 Analog input signal selection	 V: F00.20 for XX0X, -10V~+10V voltage signal input  I: F00.20 for XX1X, 4~20mA current signal input	F00.20 for 0000 -10V~+10V
SW3	AO1 Analog output signal selection	 V: F00.21 for XX00 0~+10V voltage signal output	F00.21 for 0000 0~+10V
SW4	AO2 Analog output signal selection	 I: F00.21 for XX11 4~20mA current signal input	
SW5	EMI Inhibition of select Terminal	 : earthed  : suspend	suspend



note

- (1) In the graphic of the toggle switch, the black square shows the position of the toggle switch.
- (2) When under the serious interfering environment, we suggest that putting the EMI dip switch to the ground, and make sure  terminal taking to the earth.

3.6.2 Descriptions for control CPU board

(1) The terminal CN3 and CN4 on CPU board are arranged as follows.

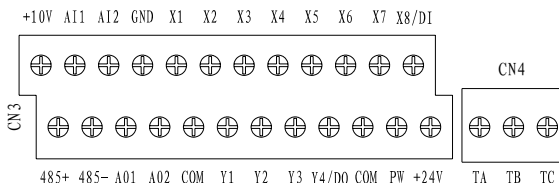

(2) CN3 and CN4 terminal function description as Table 3-5.

Table 3-5 CPU board terminal function table

item	symbol	name	Function description and Spec
Multifunction input terminal	X1	Multifunction input 1	The range of voltage input: 15~30V; Optocoupler isolation, Compatible with bipolar input; Input impedance: 4.7KΩ The max input frequency: 1KHz
	X2	Multifunction input 2	
	X3	Multifunction input 3	
	X4	Multifunction input 4	
	X5	Multifunction input 5	
	X6	Multifunction input 6	
	X8/DI	Multifunction input terminal 8/ high-speed pulse input terminal	Besides the function of X1~X7, can also be used as high-speed pulse input Input impedance: 2.2KΩ the max frequency: 50KHz
Power supply	+24V	+24V Power supply	Provide +24V power supply (24±4V) The max output current: 200mA
	PW	External power input terminal	Connecting to +24 is factory default; connecting external power and cutting off +24V power terminal is needed when using external signal to drive X terminal.
	+10V	+10V power supply	Provide +10V power (10±0.5V) The max output current:50mA
	COM	Common end	Reference ground of digital signal and +24V power
	GND	Common end	Reference ground of analog signal and +10V power supply
Analog value input	AI1	Analog value input 1	Input range: DC 0V~10V/4~20mA, decided by SW1 Input impedance: 20KΩ when voltage input; 250Ω when current input. resolution: 1/4000
	AI2	Analog value input 2	Input range: DC -10V~10V/4~20mA, decided by second bit on LED of parameter F00.20 and slide switch of SW2

			Input impedance: 20K Ω when voltage input; 250 Ω when current input. resolution: 1/2000
Analog value output	AO1	Analog value output 1	Output of voltage or current is decided by SW3(AO1) and SW4(AO2) Range of voltage output: 0~10V Range of current output: 4~20mA
	AO2	Analog value output 2	
Multifunctional output terminal	Y1	Open circuit collector output terminal 1	Optocoupler isolation output, unipolar Open circuit collector output Max voltage output: 30V Max current output: 50mA
	Y2	Open circuit collector output terminal 2	
	Y3	Open circuit collector output terminal 3	
	Y4/DO	Open circuit collector output terminal 4/ High-speed impulse output	
Relay output	TB—TC	Normally closed terminal	Contact capacity: AC250V/2A (cos ϕ =1) AC250V/1A (cos ϕ =0.4) DC30V/1A
	TA—TC	Normally open terminal	
Communication interface	485+	485 differential signal interface	485 differential signal positive end
	485-		485 differential signal negative end
Assist interface	CN2	retain	
	CN6	Standard RS485 communication interface	Connected by twisted-pair or STP

(3) Terminal RS485, arranged as follows

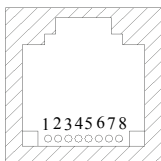

RS485 terminal CN6 arrangement								
order	1	2	3	4	5	6	7	8
name	485+	-	485-	-	-	GND	-	+5V

3.6.3 Analog input&output terminal wiring

(1) AI1 terminal accepts analog voltage or current signal end input and switchover by SW1, wiring as follows:

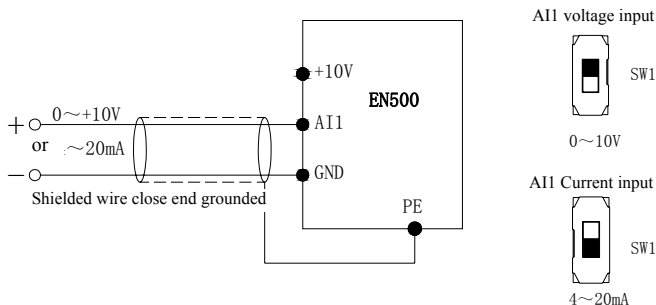

Fig.3-11 AI1 terminal wiring diagram

(2) AI2 terminal accepts analog voltage or current signal end input and switchover by SW2, which must be coordinated with the ten bit on LED when setting parameter F00.20, the wiring as follows

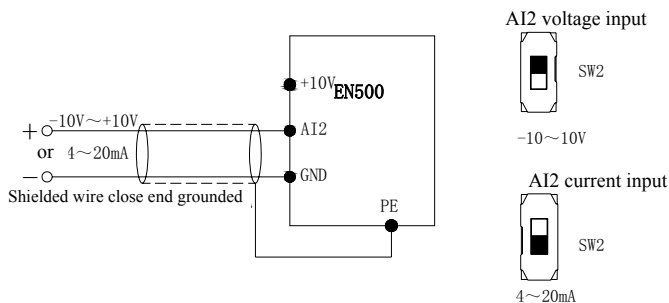

Fig.3-12 AI2 terminal wiring diagram

(3)AO1, AO2 terminal can connect external analog meter, which can indicate several physical quantity , can select output analog voltage or current signal, switchover by SW3 and SW4. wiring mode as follows:

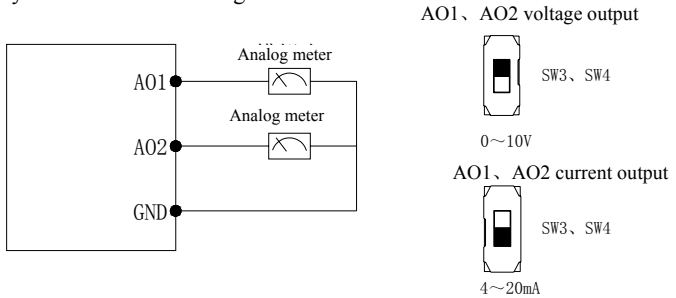

Fig.3-13 AO1, AO2 terminal wiring diagram



Note

1. when use analog input, filter electric or common mode choke can be installed between AI1 and GND or AI2 and GND
2. Analog input, output signal is easily disturbed by the external, Shielding electric cable must be used and earthed when wiring, and the wiring should be short enough.

3.6.4 Digital input terminal wiring.

(1) The connecting way when using the +24V power inside and the external controller is NPN source electrode as follows.

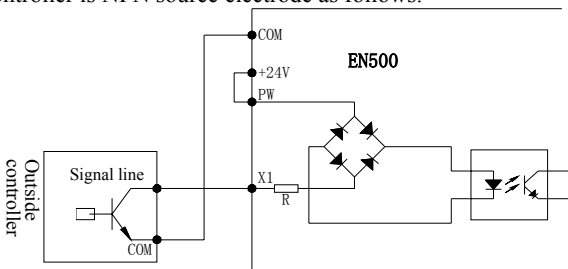

Fig.3-14 Source electrode connection way when using 24V inside

- (2)The connecting way when using the +24V power inside and the external controller is PNP drain electrode as follows.

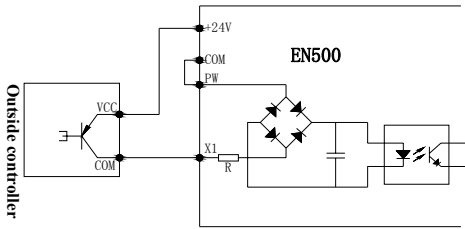

Fig.3-15 Drain electrode connection way when using 24V inside

- (3) The connection way when the external DC current is 15~30V and the external controller is NPN type.(please remove the short connection slice between PW and +24V)

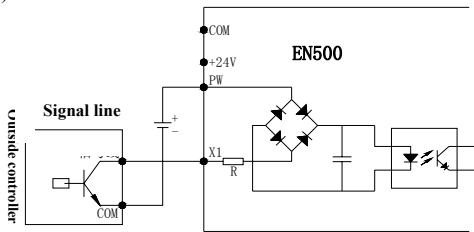

Fig. 3-16 The source electrode connection way when using external power

- (4) The connection way when the external DC current is 15~30V and the external controller is PNP type.(please remove the short connection slice between PW and +24V)

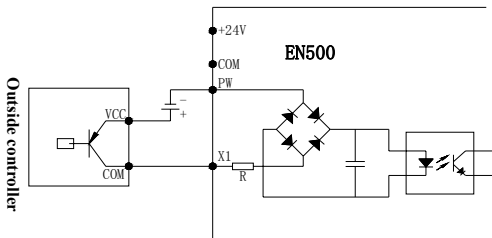

Fig. 3-17 The drain electrode connection way when using external power.

3.6.5 The communication terminal wiring.

EN500 inverter provides RS485 serial communication interface for the user. Following wiring methods make single-main single-sub control system or single-main multi-sub control system possible. Using upper machine(PC or PLC controller)software can realize real time supervision to inverter in the Industrial control system so that realize complicated run control such as long-distance control, high automatization etc; you can also take one inverter as mainframe and the others as submachine to form cascade or synchronous control network.

- (1) When inverter RS485 interface connected to other devices with RS485 interface, you can connect wire as below figure.

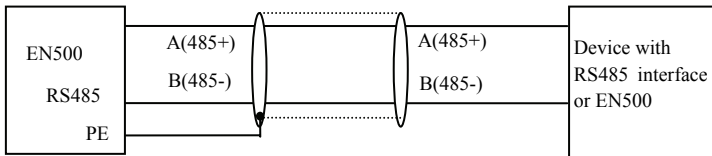

Fig.3-18 Communication terminal wiring

- (2) The connection between RS485 interface and upper machine (with the RS232 interface)

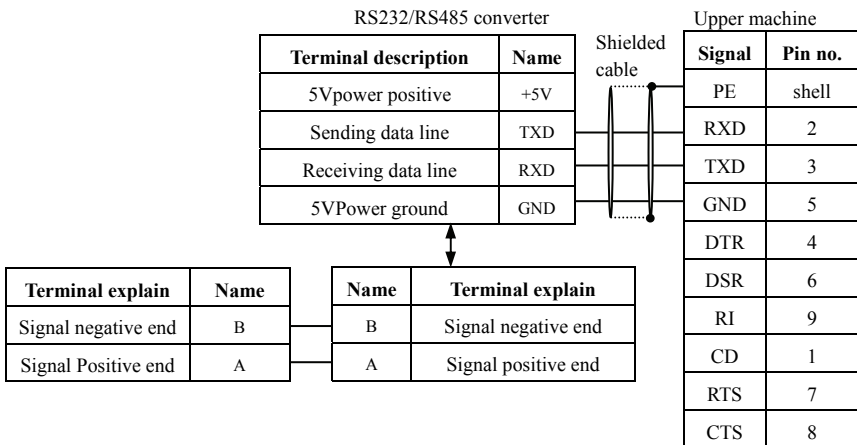

Fig.3-19 RS485 communication wiring

4 EMC Electromagnetic Compatibility Explanation

The Inverter when working can generate electromagnetic noise and to reduce or stop this the inverter should be wired using the below procedures. show you assembling method of inverter disturbance suppressing from many aspects such as disturbance suppressing, spot wiring, system grounding, leak current, usage of power supply filter etc. the customer in accordance with the instructions in this section will be installed and used in general industrial environments will have good electromagnetic compatibility.

4.1 Restraining to noise disturbance

Disturbance brought by the working inverter may affect nearby electronic device, effect degree relates to surrounding electromagnetic environment of the inverter and anti-disturbance capacity of this device.

4.1.1 Type of disturbance noise

According to work principle of the inverter, there are mainly 3 kinds of noise disturbance source:

- (1) circuit conduction disturbance;
- (2) space emission disturbance;
- (3) electromagnetic induction disturbance;

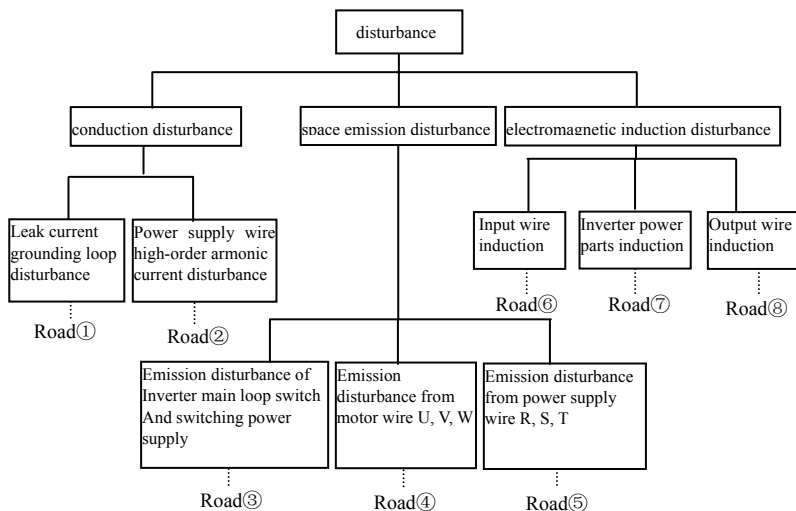

Fig.4-1 type of noise disturbance

4.1.2 Noise spread road

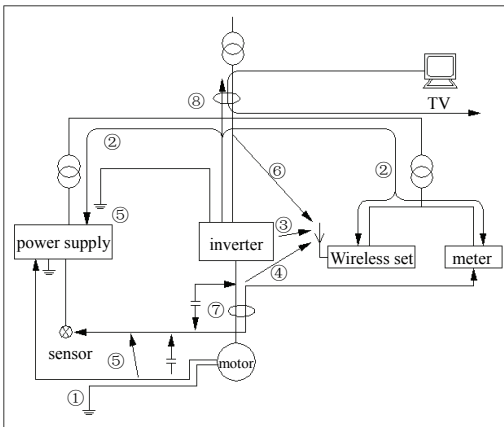

Fig.4-2 noise disturbance spread road sketch

4.1.3 Basic countermeasure for suppressing disturbance

Table 4-1 disturbance suppressing countermeasure table

Noise spread road	Countermeasure of weakening effect
①	When grounding wire of peripheral device and wiring of the inverter compose closed-loop, inverter grounding wire leakage current would make the device do wrong action. Can reduce wrong action if the device is not earthed here.
②	High-order harmonic from the inverter would make voltage and current transmit through power supply wire when peripheral device and the inverter electrified by same power supply, would disturb other devices in this same power supply system, can take following suppressing measure: assemble electromagnetic noise filter at inverter input end; isolate other devices by isolation transformer; connect power supply for peripheral device with remote power source; install ferrite filter magnetic circle for R, S, T three-phase conducting wire of the inverter to suppress conduction of high-frequency harmonic current.

③④⑤	<ul style="list-style-type: none"> ● Keep device and signal wire prone to disturbance from the inverter. Should use shielded signal wire, shielding layer single end earthed and try best to keep away from the inverter and its input, output wire. If signal wire must intersect strong power cable, must keep them in real intersection and avoid parallel. ● Install high-frequency noise filter(ferrite common module choke, folksay magnetic circle) separately at input, output root, which can effectively suppress emission disturbance from dynamic wire. ● Should place motor cable shield of biggish thickness, for instance set it in tube with biggish thickness (above 2mm) or bury it in cement slot. Dynamic wire set into metal tube and use shielding wire to be grounded (use 4-core motor cable, one side is earthed through the inverter, the other side connected to motor shell).
⑥⑦⑧	<p>To prevent parallel or bundled power and weak conducting wire; should keep away from inverter mounted device to the best and its wiring should keep away from power wire of the inverter such as R, S, T, U, V, W etc.. Should pay attention to relative mounting place between device with strong electric field or strong magnetic field and the inverter, should keep distance and vertical intersection.</p>

4.2 Local wiring and earthing

- (1) The distance between motor wire (U, V, W terminal education wire) and power supply wire (R, S, T terminal input wire) should be far away enough

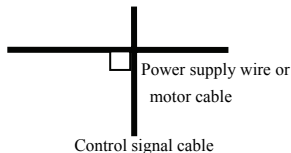

Fig.4-3 system wiring demand

- (2) Try your best to place motor table from U, V, W terminals in metal tube or metal wiring slot.
- (3) Should use shielded cable as common control signal cable, shielding layer close-to-inverter side earthed after connected with PE terminal of inverter.
- (4) Cable educed from inverter PE terminal must be connected directly to earth-plate and can't be connected to ground through grounding wire of other devices.
- (5) Powerful cable(R, S, T, U, V, W)should not parallel control signal cable closely, say nothing of being bundled together, must keep distance of 20~60cm above (related to size of powerful current). Should cross each other vertically if intersection, as Fig.4-3.
- (6) Powerful grounding wire must be connected to earth separately from weak grounding cable such as control signal and sensor cable etc.
- (7) Forbid to connect other electricity consumption device to inverter power supply input end(R, S, T)

4.3 Leak current and countermeasure

The leak current flows past wire to wire capacitance and motor capacitance of input and output of inverter. The amount of leak current is based on the distributed capacitance. Leak current has to types: Earth leak current and line leak current. The following ways is to restrain.

- (1) Reduce effectively the length of wire between the inverter and motor.
- (2) Install ferrite bead or electric reactor at the side of the output of inverter.



End voltage of the motor will be reduced markedly when installing reactor of 5% above rated voltage drop and make long-distance wiring to U, V, W. Fully loaded motor have the danger of burning itself, should work in lower volume or step up its input output voltage.

- (3) Reduce carrier wave frequency, but the motor noise would increase accordingly

4.4 Installation demand for electromagnetic on-off electronic device

For these electromagnetic on-off electronic device like Relay, magnetic control conductor and electromagnetic iron etc., which would bring lots of noise during work. So you should pay full attention to when installing them beside the inverter or in the same control chamber with the inverter and must install surge absorbing device as shown in Fig. 4-4.

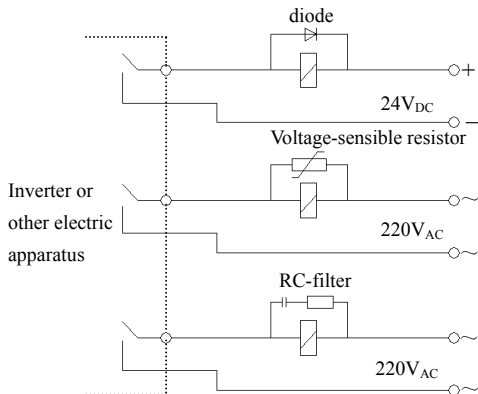

Fig.4-4 installation demand for electromagnetic on-off device

4.5 Noise filter installation instructions

- (1) strict accordance ratings use; filter metal enclosure must be reliably connected with the installation of large metal cabinet ground, and requires a good electrical continuity, otherwise there will be danger of electric shock and seriously affect the EMC effect.
- (2) filter to the drive PE terminal must be connected to the same common ground, otherwise it will seriously affect the EMC effect.
- (3) filter should be close to the power input of the inverter when installed.



5 Run and operation explanation for inverter

5.1 Run of inverter

5.1.1 Running order channels

There are 3 kinds of order channel for controlling run action of the inverter such as run,stop,jog etc.,

0: keypad

Control by key  ,  ,  on keypad(factory default).

1: Control terminal

Use control terminal FWD,REV,COM to make of double-line control, or use one terminal of X1~X8 and FWD or REV to make of three-line control.

2: Communication port

Control run and stop of the inverter through upper machine or other device which can communicate with the inverter.

Choose order channel by setting function code F01.15; and also can choose by multi-function input terminal(F08.18~F08.25 choose function 49,50,51,52,53).

Also can reach switch the command channel through multi-function key  .



Please make switching debugging in advance when switch the order channel to check if it can fulfill system requirement, otherwise have danger of damaging device and injuring personal.

5.1.2 Frequency-provision channel

EN500 common run mode there are main frequency provision and assist frequency provision:

Main frequency provision:

0: keypad analog potentiometer provision;

1: AI1 analog setting;

2: AI2 analog setting;

3: terminal UP/DOWN adjustment provision;

4: communication provision(Modbus and external bus share a main frequency memory);

5: EAI1 analog setting(extend effective);

6: EAI2 analog setting(extend effective);

7: high speed pulse provision(X8 terminal need select the corresponding function);

8: terminal pulse width provision(X8 terminal need select the

corresponding function);

9: terminal encoder provision(X1,X2 terminal connect to the encoder orthogonal input)

10: keypad analog potentiometer provision(need to select the analog potentiometer keypad parts)

11~14: reserved

Assist frequency provision:

0: keypad analog potentiometer provision;

1: AI1 analog setting;

2: AI2 analog setting;

3: terminal UP/DOWN adjustment provision;

4: communication provision(Modbus and external bus share a main frequency memory);

5: EAI1 analog setting(extend effective);

6: EAI2 analog setting(extend effective);

7: high speed pulse provision(X8 terminal need select the corresponding function);

8: terminal pulse width provision(X8 terminal need select the corresponding function);

9: terminal encoder provision(X3,X4 terminal connect to the encoder orthogonal input)

10: keypad analog potentiometer provision(need to select the analog potentiometer keypad parts)

11~20: reserved

5.1.3 Work state

Work state of EN500 is classified as waiting state and running state, waiting state, If there is no running command after the inverter electrified or after stop command during running state, the inverter enters into waiting state. running state, the inverter enters into running state after receiving run command. Parameter setting state, after receiving the parameter identification command, enter the parameter setting state, after tuning into the shutdown state.

5.1.4 Run mode

EN500 inverter have 6 kinds of run mode, following is in turn according to their priority, jog run → closed-loop run → PLC run → multisection speed run → swing frequency run → common run. Shown as Fig.5-1.

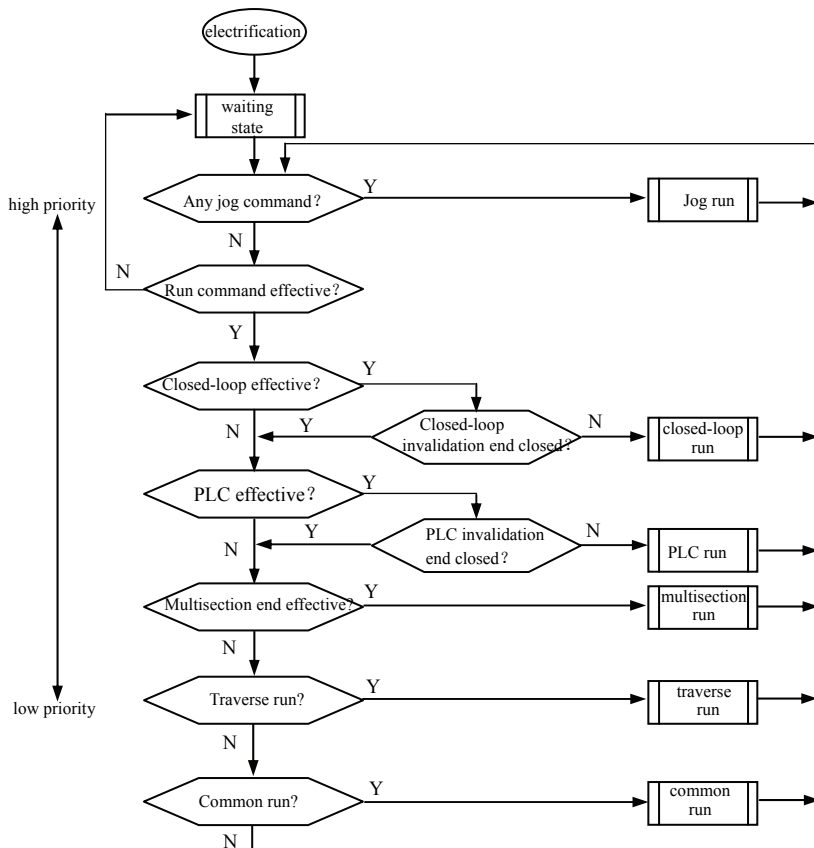



Fig.5-1 logic flow chart of EN500 inverter run state

0: jog run

Upon receiving jog run command (for instance, press the  key on keypad) during waiting state, the inverter run at jog frequency (see function code F01.25~F01.29).

1: closed-loop run

The inverter will come into closed-loop run mode when closed-loop run control effective parameter is set(F11.00=1 or F12.00 \geq 1). Namely carry on PID adjustment to specified value and feedback value(proportion integral differential calculation, see F11 group function code) and PID adjuster output is inverter output frequency. Can make closed-loop run mode ineffective and switch to lower level run mode by multi-function terminal (function 31).

2: PLC run

The inverter will enter into PLC run mode and run according to run mode preset(see F10 group function code description) through setting PLC function effective parameter(F10.00 last bit \neq 0). Can make PLC run mode ineffective and switch to lower level run mode by multi-function terminal (function 36).

3: multi-section speed run

By nonzero combination of multi-function terminal(5,6,7,8,function), choose multisection frequency 1~15(F10.31~F10.45) to run at multisection speed.

4: swing frequency run

The inverter will enter into swing frequency run mode when swing frequency function effective parameter(F13.00=1)is set. Set relevant swing frequency run special parameter according to textile swing frequency craft to realize swing frequency run.

5: common run

Common open loop run mode of general inverter.

In above 6 kinds of run mode except “jog run” the inverter can run according to kinds of frequency setting method.

5.2 Operation and use of key board

5.2.1 Keypad layout

The operating keyboard is the main unit of frequency inverter to accept commands, display parameters. Keyboard outline diagram shown in Figure 5-2.

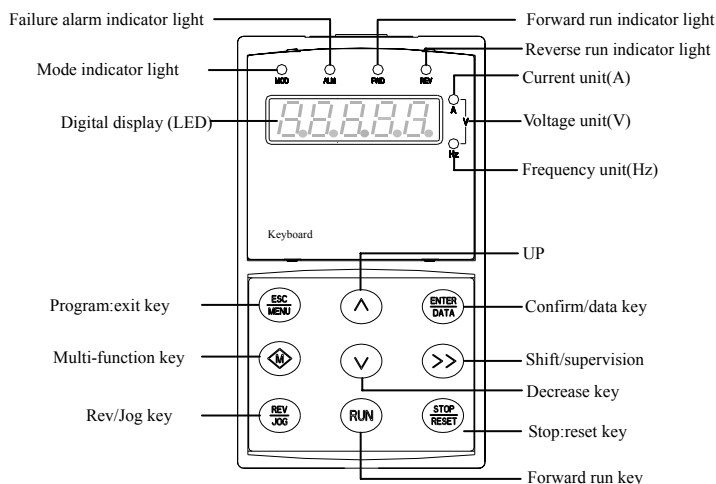





Fig.5-2 keypad layout sketch

5.2.2 Keypad function description

There are 9 key-presses and one adjusting button for analog potentiometer on inverter Keypad and function definition of each key is as shown in table 5-1.

Table 5-1 keypad function table

Key	Name	Function description
	Program/Exit key	Enter into or exit programming state
	Shift/Supervision key	Can choose modification digit of set data under editor state; can switch display status supervision parameter under other state
	Function/Data key	Enter into the next menu or data confirmation
	Rev/Jog key	Under keypad mode:to press this key can set reverse run or Jog run according to the 1 st bit of parameter F00.15
	Run key	Enter into forward run under keypad mode

	Stop/reset key	In common run status the inverter will be stopped according to set mode after pressing this key if run command channel is set as keypad stop effective mode. The inverter will be reset and resume normal stop status after pressing this key when the inverter is in malfunction status.
	Multi-function key	The specific function keys decided by tens digit of F00.15 see F00.15 parameter descriptions
	Increasing button	To increase data or function code (to press it continuously can improve increasing speed)
	Decreasing button	To decrease data or function code (to press it continuously can improve decreasing speed)

5.2.3 LED and indicator light

4 status indicator light:they are MOD(mode):ALM(alarm):FWD(forward run):REV(reverse run)from left to right on the LED:their respective indicating meaning is as shown in table 5-2.

Table 5-2 status indicator light description

Item		Function description	
Display function	Digital display	Display current run status parameter and set parameter	
	Status indicator light	A,Hz,V	Unit for relevant current digital displayed physical parameter(for current is A:for voltage is V:for frequency is Hz)
		MOD	This indicator light is lit in non-supervision status and extinguished if no key pressed for a minute:then come back to supervision status
		ALM	Alarm indicator light:indicate that the inverter is in over current or over voltage suppressing status or failure alarm status currently
		FWD	Forward run indicator light, indicate that the inverter output forward phase order and the connected motor rotate in forward direction
		REV	Reverse run indicator light:indicate that the inverter output reverse phase order and the connected motor rotate in reverse direction
		The inverter work in DC brake status if FWD,REV indicator light is lit at the same time	

5.2.4 Key board display status

EN500 keypad display status is classified as waiting status parameter display:function code parameter editing status display:malfunction alarm status display:run status parameter display in total 4 kinds of status. LED indicator light will all be lit after the inverter electrified:then enter into set frequency display. As shown in Fig.5-3 a

(1) Waiting parameter display status

The inverter is in waiting status and waiting status supervision parameter is displayed on keyboard: normally parameter F00.13 decide which status supervision parameter to be displayed. As shown in Fig.5-3 b, the unit is indicated by rightward unit indicator light.

To press \gg key, it can display different waiting status supervision parameter circularly: for detail please see C-00 to C-05 group supervision parameter details decide by F00.07~F00.12.

(2) Run parameter display status

The inverter enters into run status when receiving effective run command and normally parameter F00.13 decide which status supervision parameter to be displayed on the keypad. As shown in Fig.5-3 c, unit is displayed by rightward unit indicator light.

To press \gg key, can display run status supervision parameter circularly. for detail please see C-00 To C-05 group supervision parameter details decide by F00.01~F00.06.

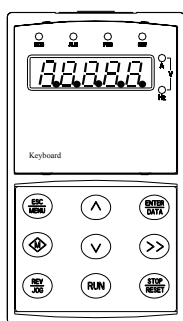

Fig.a electrification, display 8.8.8.8.8.

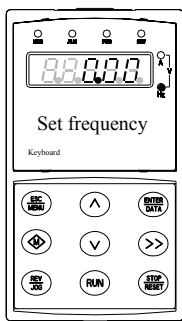

Fig.b waiting status, display waiting status parameter

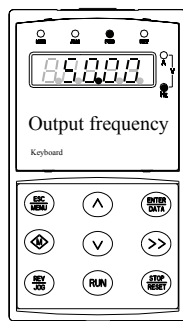

Fig.c run status:display run status parameter

Fig.5-3 inverter electrification: waiting: run status display

(3) Failure alarm display status

The inverter enters into failure alarm display status upon detecting failure signal and display failure code sparklingly(as shown in Fig.5-4);

To press \gg key can look over relative parameter after stopping running; Can press ESC MENU key to enter into program status

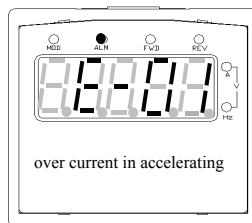

Fig.5-4





to see about Fd group parameter if want to search failure information.

Can carry on failure restoration by  key: control terminal or communication command on the keypad after troubleshooting. Keep displaying failure code if failure exist continuously.



For some serious failure, such as inverse module protect, over current: over voltage etc.: must not carry on failure reset forcibly to make the inverter run again without failure elimination confirmed. Otherwise have danger of damaging the inverter !

(4) Function code editing status

Under waiting: run or failure alarm status, press  key, can enter into editing status(If user password is set, can enter into editing status after inputting the password, see also F27.00 description and Fig.5-10), and editing status is displayed according to three classes menu mode, as shown in Fig. 5-5. To press  key can enter into one class by one class. Under function parameter display status, to press  key to carry on parameter storage operation; To press  key can only come back to upper class menu without storing modified parameter.

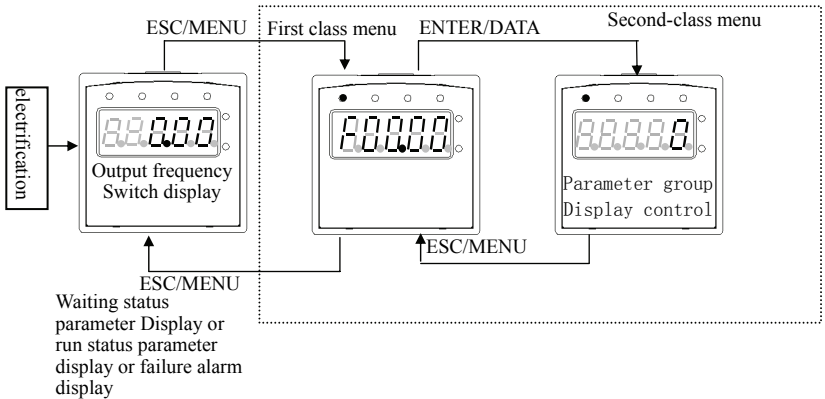

Fig.5-5 keypad display status switching

(5) Alarm state display

When under running and standby situation:

it mean enter failure alarm display status upon detecting failure signal and display failure code sparkingly (Fig5-6) Inverter keeping running state But this alarm display can not be reset button eliminated: After only find the cause of the alarm:

in order to eliminate this factor Normal.

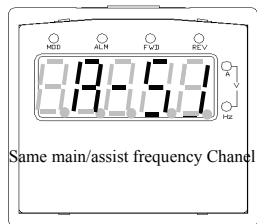

Fig.5-6

5.2.5 User Management Parameters

In order to facilitate the user parameter management: EN500 component model parameter menu for display management. The parameters do not need to be displayed can be shielded.

(1) Method parameter setting mode display.

By setting F00.00 = 0,1,2,3 respectively parameter mode is set: Basic menu mode: menu mode Intermediate: Advanced menu mode and user menu mode.

Basic menu	F00,F01,F02,F03,F26,F27
Middle menu	Display all parameters except expansion:virtual parameters and parameter group reservations
Advance menu	F00,F01,F02,F03,F04,F05,F06,F07,F08,F09,F10,F11,F12,F13,F14, F15,F16,F17,F18,F19,F20,F21,F22,F23,F24,F25,F26,F27
User custom	F25 group parameter confirmed

5.2.6 Method for operating keypad

Can carry on various operation to the inverter through keypad, for example:

(1) Status parameter display switching:

After pressing key **>>**, display C group status supervision parameter; after displaying one supervision parameter code for 1 second:will display this parameter value automatically, to press **ENTER DATA** key ,return back to C-00 supervision interface.

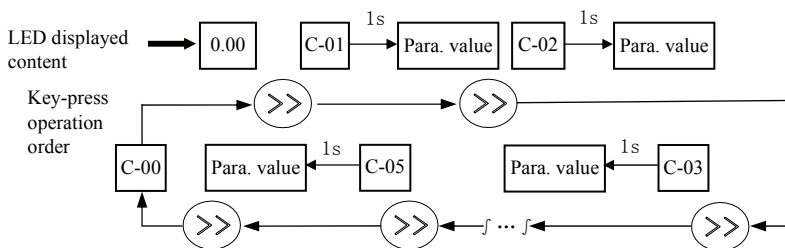

Fig. 5-7 waiting status parameter display operating example

(2) Function code parameter setting

Take function code F01.01 modified from 5.00Hz to 6.00Hz as example.
 Boldface in Fig.5-8 shows flickering digit.

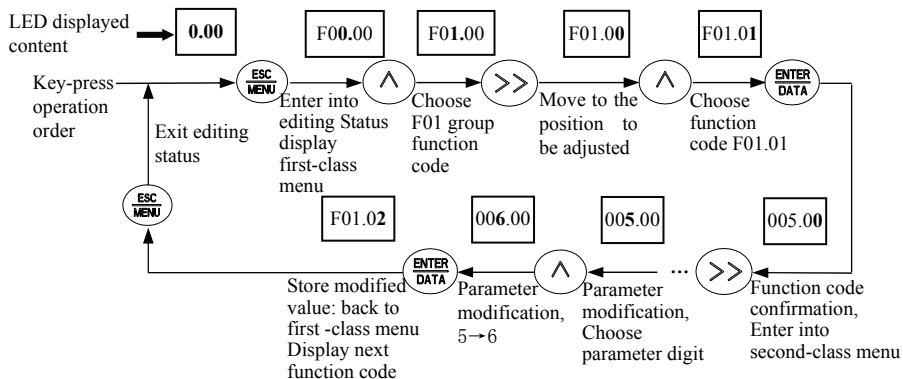

Fig.5-8 example for parameter setting and modification

Description: under second -class menu: if the parameter has no blinking digit, this function code can't be modified, possible reasons are as follows:

- 1> This function code shouldn't be modified: for example actual detected status parameter: run record parameter etc.;
- 2> This function code can't be modified under run status and can be changed after stopping running;
- 3> Parameter protected. All the function code can't be modified when function code F00.14=1 or 2, in order to avoid wrong operation. Need to set the function code F00.14 to 0 if you want to edit function code parameter.

(3) Specified frequency adjustment for common run

Take example modifying specified frequency from 50.00Hz to 40.00Hz at

F01.06=1, F01.03=0 during running for explanation.

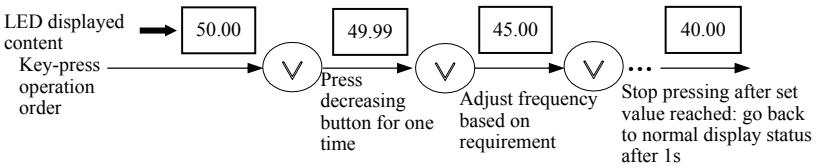

Fig. 5-9 set frequency adjustment operation example

(4) Jog run operation

For example: keypad as current run command channel: jog run frequency 5Hz:waiting status.

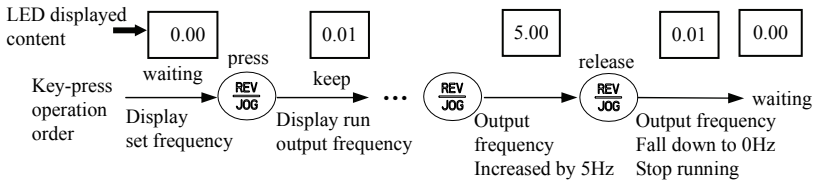

Fig.5-10 Jog run operating example

(5) Operation for entering to function code editing status after setting user password

“User password” F27 is set to “12345”. Boldfaced digit in Fig.5-11 shows blinking bit.

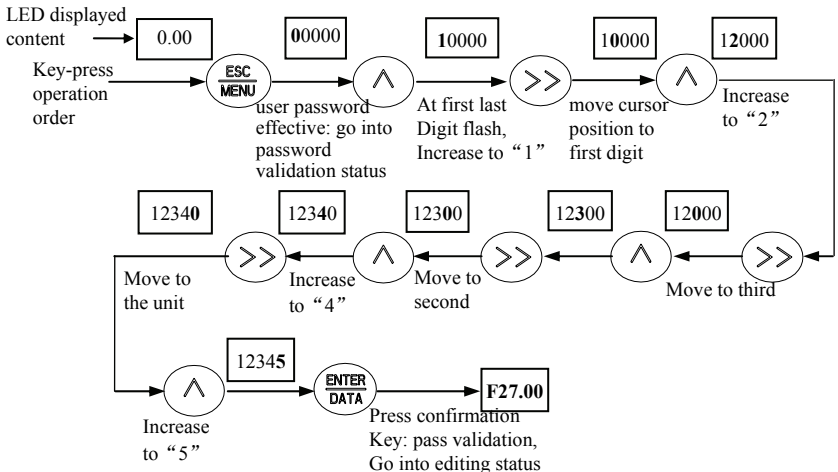



Fig.5-11 inputting password to go into function code operation

(6) See about failure parameter under failure status:

If press  key under failure status the user can quickly locate to the F26 group function code parameter. Press  can quickly switch value between F26.06 ~ F26.10 parameters and fault alarm, easy to view the fault records.

(7) Keypad key-press locking operation

Under unlocked keypad situation, press  key for 2s to lock the keypad. For detailed operation please refer to 2nd bit of F00.14 function code.

(8) Keypad key-press unlocking operation

Under locked keypad situation, press  key for 2s to unlock the keypad.

5.3 Inverter electrification

5.3.1 Check before electrification

Please carry on wiring based on operation requirement provided in “inverter wiring” of this Service manual.

5.3.2 First electrification

Close input side AC power supply switch after correct wiring and power supply confirmed: electrify the inverter and keypad LED display “8.8.8.8.8”, contactor closed normally: LED displayed set frequency shows that electrification is finished. First electrification operation process is shown as Fig.5-12:

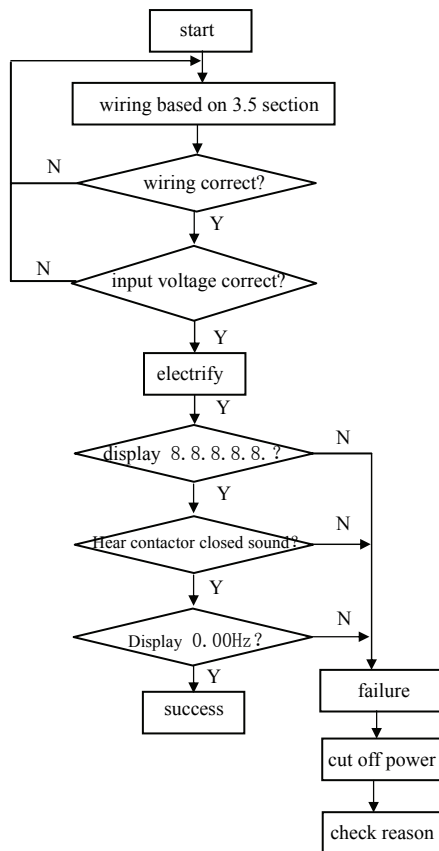

Fig. 5-12 first electrification operation flow

6 Function parameter schedule graph









6.1 Symbol description







- × ---- parameter can't be changed in process of running
 ○ ---- parameter can be changed in process of running
 * ---- read-only parameter, unmodifiable

6.2 Function parameter schedule graph

F00—System Parameter Group					
Function code	Name	Set range	Min. unit	Factory default	Modification
F00.00	Parameter group display control	0:Basic list mode(only displayF00~F03 basic control parameter group and F26 fault record parameter group.) 1:Middle list mode.Display all parameter except for extension: virtual and reserve parameter group. 2: Senior list mode. All parameter display. 3:User list mode.Display parameter defined by user: and monitor parameter: F00.00 display all the time.	1	0	○
F00.01	C-00 display parameter selection when operation	0:main setup frequency(0.01Hz) 1:auxiliary setup frequency(0.01Hz) 2:setup frequency(0.01Hz) 3:output frequency(0.01Hz) 4:output current(0.1A) 5:output voltage(1V) 6:DC busbar voltage(0.1V) 7:motor speed(1 circle/min) 8:motor line velocity(1 circle/min) 9:inverter temperature(1℃) 10:run time already this time(0.1min) 11:current accumulate run time(1h) 12:current accumulate power-on time(1h) 13:inverter status 14:input terminal status 15:output terminal status 16:extension output terminal status 17:extension input terminal status 18:communication virtual input terminal status 19:internal virtual input node status 20:analog input AI1(after checkout) (0.01V / 0.01mA) 21:analog input AI2(after checkout) (0.01V / 0.01mA) 22:extension analog input EAI1(after checkout)(0.01V / 0.01mA) 23:extension analog input EAI2(after checkout)(0.01V / 0.01mA) 24:analog AO1 output(0.01V /0.01mA) 25:analog AO2 output(0.01V /0.01mA) 26:extension analog EAO1 output (0.01V /0.01mA)	1	3	○

		27:extension analog EAO2 output (0.01V /0.01mA) 28:external pulse input frequency(1Hz) 29:operation panel potentiometer voltage(0.01V) 30:process PID provide(0.01V) 31:process PID feedback(0.01V) 32:process PID deviation(0.01V) 33:process PID output(0.01Hz) 34:simple PLC current segment No. 35:external multi-speed current segment No. 36:constant pressure water supply provide pressure(0.001Mpa) 37:constant pressure water supply feedback pressure(0.001Mpa) 38:constant pressure water supply relay status 39:current length(1M) 40:accumulate length(1M) 41:current internal count value 42:current internal time value 43:run command setup channel(0:keyboard 1:terminal 2:communication) 44:main frequency provide channel 45:auxiliary frequency provide channel 46:rated current(0.1A) 47:rated voltage(1V) 48:rated power(0.1KW) 49~65:reserve			
F00.02	C-01 display parameter selection when operation	Same as above	1	2	○
F00.03	C-02 display parameter selection when operation	Same as above	1	4	○
F00.03	C-03 display parameter selection when operation	Same as above	1	5	○
F00.05	C-04 display parameter selection when operation	Same as above	1	6	○
F00.06	C-05 display parameter selection when operation	Same as above	1	9	○
F00.07	C-00 display parameter selection when stop	Same as above	1	2	○
F00.08	C-01 display parameter selection when stop	Same as above	1	6	○
F00.09	C-02 display	Same as above	1	48	○

	parameter selection when stop				
F00.10	C-03 display parameter selection when stop	Same as above	1	14	○
F00.11	C-04 display parameter selection when stop	Same as above	1	20	○
F00.12	C-05 display parameter selection when stop	Same as above	1	9	○
F00.13	Power-on fault monitor parameter selection	0~5	1	0	○
F00.14	Parameter operation control	<p>LED units digit: Parameter modification operations</p> <p>0: All parameters are allowed to be modified</p> <p>1: Except current parameter, all other parameters are not allowed to modify the</p> <p>2: Except F01.01, F01.04 and current parameter, all other parameters are not allowed to be modified</p> <p>LED tens digit: Reset to factory defaults</p> <p>0: No action.</p> <p>1: All parameters return to default. (not include fault record parameter group (F26 group) parameter).</p> <p>2: Except for motor parameter: all parameters return to default. (not include F15 and F26 group parameter).</p> <p>3: Extension parameter return to default. (only F21~F24 group parameter return to default).</p> <p>4: Virtual parameter return to default. (only F20 group parameter return to default).</p> <p>5: Fault record return to default. (only fault record parameter group (F26 group) parameter return to default)</p> <p>LED hundreds digit: Key operation</p> <p>0: All locked</p> <p>1: Except , the others locked</p> <p>2: Except , , , the others locked</p> <p>3: Except , , the others locked.</p> <p>4: Except , , the others locked.</p>	1	000	×

F00.15	Button function selection	<p>LED units digit: panel  button selection</p> <p>0: Reversal command action button</p> <p>1: Jog action button</p> <p>LED tens digit:  multi-function button function selection</p> <p>0:Invalid.</p> <p>1:Jog run. multi-function button as jog run button: run direction decided by unit bit of F01.16's LED.</p> <p>2:For/rev switching. press this button to change the run direction when run: then press the same button chang to another direction.</p> <p>3:Free stop. setup free stop function and stop mode F02.11 the same function with 1 Jog run.</p> <p>4:Switching to run command provide mode as the setup order of F00.16.</p> <p>5~9:Reserve</p> <p>LED hundreds digit: terminal run command control</p> <p>0: Keyboard  button invalid</p> <p>1: Keyboard  button valid</p> <p>LED thousands digit: communication run command control</p> <p>0: Keyboard  button invalid</p> <p>1: Keyboard  button valid</p>	1	0001	○
F00.16	Multi-function key command channel switching order selection	<p>0: Keyboard control→ terminal control→ communication control</p> <p>1: Keyboard control←→terminal control</p> <p>2: Keyboard control←→communication control</p> <p>3: Terminal control←→communication control</p>	1	0	○
F00.17	Motor speed display coefficient	0.1~999.9%	0.1%	100.0%	○
F00.18	Line speed display coefficient	0.1~999.9%	0.1%	1.0%	○
F00.19	Reserved				

F00.20	Analog input terminal configuration	LED units digit: AI1 configuration 0: 0~10V input 1: 4~20mA input LED tens digit: AI2 configuration 0: -10~10V input 1: 4~20mA input LED hundreds digit: EAI1 configuration 0: 0~10V input 1: -10~10V input 2: 4~20mA input LED thousands digit: EAI2 configuration 0: 0~10V input 1: -10~10V input 2: 4~20mA input	1	0000	×
F00.21	Analog output terminal configuration	LED units digit: AO1 configuration 0: 0~10V output 1: 4~20mA output LED tens digit: AO2 configuration 0: 0~10V output 1: 4~20mA output LED hundreds digit: EAO1 configuration 0: 0~10V output 1: 4~20mA output LED thousands digit: EAO2 configuration 0: 0~10V output 1: 4~20mA output	1	0000	×
F00.22	Y output terminal configuration	LED units digit~LED hundreds digit: reserved LED thousands digit: Y4 output configuration 0: Open collector output 1: DO output	1	0000	×
F00.23	G/P type setup	0: G type. 1: P type.	1	0	×
F00.24	Motor control mode	0: V/F control 1: Speedless Vector Control 2: Reserved	1	0	×
F00.25	Reserved				
F00.26	Reserved				
F00.27	Reserved				

F01 — Basic Run Function Parameter Group

Function code	Name	Set range	Min. unit	Factory default	Modification
F01.00	Main frequency input channel selection	0: Operation keyboard digital setup 1: AI1 analog setup 2: AI2 analog setup 3: Terminal UP/DOWN adjusting setup 4: Communication provide. 5: EAI1 analog setup. 6: EAI2 analog setup 7: High speed pulse setup X8 terminal need choose the suitable function) 8: Terminal pulse setup(X8 terminal need choose the suitable function) 9: Terminal encoder setup(X1:X2 connect the	1	0	○

		encoder punctuation input) 10:Keyboard analog potentiometer setup(need choose the analog Potentiometer keyboard parts) 11~14: Reserved			
F01.01	Main frequency digital setup	0.00Hz~upper limit frequency	0.01Hz	50.00Hz	○
F01.02	Main frequency digital control	Only when parameter F01.00=0:3:4 valid. LED units digit: power down reserve setup 0:Main frequency power down reserve. 1:Main frequency power down no reserve. LED tens digit: halt reserve setup 0:Halt main frequency hold 1:Halt main frequency recovery F01.01	1	11	○
F01.03	Auxiliary frequency input channel select	0: Operation keyboard digital setup 1: A11 analog setup 2: A12 analog setup 3:Terminal UP/DOWN adjusting setup 4:Communication provide. 5:EA11 analog setup. 6:EA12 analog setup 7:High speed pulse setup X8 terminal need choose the suitable function) 8:Terminal pulse setup(X8 terminal need choose the suitable function) 9:Terminal encoder setup(X3:X4 connect the encoder punctuation input) 10:Keyboard analog potentiometer setup(need choose the analog Potentiometer keyboard parts) 11~20: Reserved	1	1	○
F01.04	Auxiliary frequency digital setup	0.00Hz~upper limit frequency	0.01Hz	0.00Hz	○
F01.05	Auxiliary frequency digital	LED units digit: power down reserve setup 0:Auxiliary frequency power down reserve. 1:Auxiliary frequency power down no reserve. LED tens digit: halt reserve setup 0:Halt auxiliary frequency hold. 1:Halt auxiliary frequency recovery parameter F01.04	1	11	○
F01.06	Main and auxiliary provide calculating setup	0:Main frequency (complex frequency of current is main frequency). 1: Auxiliary frequency(complex frequency of current is auxiliary frequency.) 2: Plus(polarity oppose of complex and main frequency, complex frequency is zero). 3:Minus(polarity oppose of complex and auxiliary frequency, complex frequency is zero). 4:Multiplication(polarity opposed of main and auxiliary frequency: complex frequency is zero). 5:Max(the max frequency of main and auxiliary absolute value). 6:Min(the min frequency of main and	1	0	○

		auxiliary absolute value). 7:Selection no-zero value(auxiliary is not negative, main frequency prior; auxiliary is negative, complex frequency is zero).			
F01.07	Auxiliary frequency provide coefficient	0.00~10.00	0.01	1.00	○
F01.08	Coefficient after complex of main and auxiliary frequency	0.00~10.00	0.01	1.00	○
F01.09	Auxiliary frequency range selection	0:Relative upper limit frequency. 1:Relative main frequency.	1	0	○
F01.10	Auxiliary frequency source scope	0.00~1.00	0.01	1.00	○
F01.11	upper limit frequency	low limit frequency~650.00Hz	0.01Hz	50.00Hz	×
F01.12	Low limit frequency	0.00Hz~upper limit frequency	0.01Hz	0.00Hz	×
F01.13	Low limit frequency run mode	0:As low limit frequency run. 1:As setting frequency run. 2:As zero frequency run. 3:Sleep: PWM clocked at sleep mode.	1	0	×
F01.14	Sleep run hysteresis frequency	0.01Hz~upper limit frequency (This function can be used to finish the sleep mode function, realizing energy-saving operation process, and the hysteresis width can avoid inverter starting frequently in threshold)	0.01Hz	0.01Hz	○
F01.15	Run command channel selection	0:Operation keyboard run control. 1:Terminal run command control 2:Communication run command control.	1	0	○
F01.16	Run direction setup	LED units digit: Keyboard command for/rev setup(only valid to keyboard inching command) 0:Forward 1:Reverse LED tens digit: for/rev forbid(suitable for all command channel, not include inching function) 0:For/rev available. 1:Reverse not available(imposing on reverse, stop as the halt mode). 2:Forward not available(imposing on forward, stop as the halt mode)	1	00	○
F01.17	Acceleration time 1	1~60000(Acceleration time is interval accelerate from zero frequency to upper limit frequency)	1	Base on motor type	○
F01.18	Deceleration time 1	1~60000(deceleration time is the interval decelerate from upper limit frequency to zero frequency.)	1	Base on motor type	○
F01.19	Acc/dece time unit	0: 0.01s 1: 0.1s	1	1	×

		2: 1s			
F01.20	Acc/dece mode selection	0:Line acc/dece mode. 1:S curve acc/dece mode.	1	0	×
F01.21	S curve acceleration initiation segment time	10.0%~50.0% (Acceleration/deceleration time) S curve acceleration start time+ S curve acceleration raise time ≤90%)	0.1%	20.0%	○
F01.22	S curve acceleration up segment time	10.0%~70.0% (Acceleration/deceleration time) S curve acceleration start time+ S curve acceleration raise time ≤90%)	0.1%	60.0%	○
F01.23	S curve deceleration initiation segment time	10.0%~50.0% (Acceleration/deceleration time) S curve deceleration start time+ S curve deceleration raise time ≤90%)	0.1%	20.0%	○
F01.24	S curve deceleration up segment time	10.0%~70.0% (Acceleration/deceleration time) S curve deceleration start time+ S curve deceleration raise time ≤90%)	0.1%	60.0%	○
F01.25	Keyboard jog run frequency	0.00Hz~upper limit frequency	0.01Hz	5.00Hz	○
F01.26	Terminal jog run frequency	0.00Hz~upper limit frequency	0.01Hz	5.00Hz	○
F01.27	Terminal jog run frequency	0.0~100.0s	0.1s	0.0s	○
F01.28	Jog acceleration time	0.1~6000.0s	0.1s	20.0s	○
F01.29	Jog deceleration time	0.1~6000.0s	0.1s	20.0s	○

F02—Start, stop, forward/reverse, brake function parameter group

Function code	Name	Set range	Min. unit	Factory default	Modification
F02.00	Start running mode	0: Start from starting frequency 1: First brake: and then start from starting frequency 2: Start by revolving speed tracking	1	0	×
F02.01	Starting delay time	0.0~60.0s	0.1s	0.0s	×
F02.02	Starting frequency	0.0~10.00Hz	0.01Hz	0.00Hz	×
F02.03	Starting frequency duration	0.0~60.0s	0.1s	0.0s	×
F02.04	DC braking current when starting	0.0~100.0%(G type inverter rated current)	0.1%	30.0%	×
F02.05	DC braking time when starting	0.0~30.0s	0.1s	0.0s	×
F02.06	Speed track starting frequency selection	0: Current setting frequency. 1: Running frequency before power down. 2:Speed track auxiliary starting frequency.	1	2	×
F02.07	Speed track auxiliary starting frequency	0.00Hz~upper limit frequency	0.01Hz	10.00Hz	×

F02.08	Speed track starting waiting time	0.00~10.00s	0.01s	0.10s	×
F02.09	Speed track current control coefficient	1~20	1	2	×
F02.10	Speed track searching speed time	0.1~30.0s	0.1s	10.0s	×
F02.11	Stop mode	0: Deceleration stop. 1: Free stop 2: Deceleration + DC braking stop.	1	0	×
F02.12	Deceleration stop holding frequency	0.00Hz ~ upper limit frequency(This parameter is only valid for stop mode 0.)	0.01Hz	0.00Hz	×
F02.13	Deceleration stop holding time	0.00~10.00s	0.01s	0.00s	×
F02.14	Stop DC braking starting frequency	0.00~15.00Hz	0.01Hz	0.00Hz	×
F02.15	stop DC braking waiting time	0.00~30.00s	0.01s	0.00s	×
F02.16	Stop DC braking current	0.0~100.0%(G type inverter rated current)	0.1%	0.0%	×
F02.17	Stop DC braking time	0.0~30.0s	0.1s	0.0s	×
F02.18	Stop auxiliary braking current	0.0~100.0%(G type inverter rated current)	0.1%	0.0%	×
F02.19	Stop auxiliary braking time	0.0~100.0s	0.1s	0.0s	×
F02.20	Forward/reverse dead zone time	0.0~3600.0s	0.1s	0.1s	×
F02.21	Forward/reverse switching mode	0: Over zero switchover 1: Over starting frequency switchover	1	0	×
F02.22	Energy consumption braking selection	0: No energy consumption braking 1: Energy consumption braking.	1	Base on motor type	○
F02.23	Energy consumption braking voltage	115.0 ~ 145.0%(rated busbar voltage)	0.1%	125.0%	○
F02.24	Energy consumption braking use rate	0.0~100.0%	0.1%	50.0%	○
F02.25	Reserved				
F02.26	Reserved				

F03—V/F control parameter group

Function code	Name	Set range	Min. unit	Factory default	Modification
F03.00	V/F curve setting	0: Constant torque curve 1: Degression torque curve 1 (2.0 power) 2: Degression torque curve 1 (1.7 power) 3: Degression torque curve 3 (1.2 power) 4: User self-defined setting V/F curve (Confirmed by F03.04~F03.11)	1	0	×
F03.01	Torque boost mode	0: Manual boost. 1: Auto torque boost	1	0	○
F03.02	Torque boost	0.0~12.0%	0.1%	Base on motor type	○

F03.03	Torque boost cut-off frequency	0.0~100.0%(motor rated frequency)	0.1%	20.0%	○
F03.04	V/F frequency value 0	0.00 ~ V/F frequency value 1	0.01Hz	10.00Hz	×
F03.05	V/F voltage value 0	0.00 ~ V/F voltage value 1	0.01%	20.00%	×
F03.06	V/F frequency value 1	V/F frequency value 0 ~ V/F frequency value 2	0.01Hz	20.00Hz	×
F03.07	V/F voltage value 1	V/F voltage value 0 ~ V/F voltage value 2	0.01%	40.00%	×
F03.08	V/F frequency value 2	V/F frequency value 1 ~ V/F frequency value 3	0.01Hz	25.00Hz	×
F03.09	V/F voltage value 2	V/F voltage value 1 ~ V/F voltage value 3	0.01%	50.00%	×
F03.10	V/F frequency value 3	V/F frequency value 2 ~ upper limit frequency	0.01Hz	40.00Hz	×
F03.11	V/F voltage value 3	V/F voltage value 2 ~ 100.00% (motor rated voltage)	0.01%	80.00%	×
F03.12	V/F oscillation suppression factor	0~255	1	10	○

F04—Auxiliary running parameter group

Function code	Name	Set range	Min. unit	Factory default	Modification
F04.00	Jump freq. 1	0.00Hz~upper limit frequency	0.01Hz	0.00Hz	×
F04.01	Jump freq. 1 range	0.00Hz~upper limit frequency	0.01Hz	0.00Hz	×
F04.02	Jump freq. 2	0.00Hz~upper limit frequency	0.01Hz	0.00Hz	×
F04.03	Jump freq. 2 range	0.00Hz~upper limit frequency	0.01Hz	0.00Hz	×
F04.04	Jump freq. 3	0.00Hz~upper limit frequency	0.01Hz	0.00Hz	×
F04.05	Jump freq. 3 range	0.00Hz~upper limit frequency	0.01Hz	0.00Hz	×
F04.06	Slip freq. gain	0.0~300.0%	0.1%	0.0%	×
F04.07	Slip compensation limit	0.0~250.0%	0.1%	100.0%	×
F04.08	Slip compensation time constant	0.1~25.0s	0.1s	2.0s	×
F04.09	Carrier freq.	0.5~16.0K	0.1K	Base on motor type	○
F04.10	PWM optimized adjustment	LED units digit: Carrier freq. is adjusted automatically according to temperature 0: Banned. 1: Allowed. LED tens digit: low speed carrier freq. limit mode 0: No limit. 1: Limit. LED hundreds digit: carrier wave modulation system 0: 3 phase modulation. 1: 2 phase and 3 phase modulation. LED thousands digit: Asynchronous modulation: synchronization mode (valid under V/F control) 0:Asynchronous modulation. 1:Synchronous modulation (under 85Hz: Asynchronous modulation).	1	0110	×
F04.11	AVR function	0: No action	1	0	×

		1: Action all the time 2: No action only during deceleration			
F04.12	Reserved				
F04.13	Auto energy-saving operation	0: No action 1: Action	1	0	×
F04.14	Acceleration time 2 and 1 switchover frequency	0.00Hz~upper limit frequency	0.01Hz	0.00Hz	×
F04.15	Deceleration time 2 and 1 switchover frequency	0.00Hz~upper limit frequency	0.01Hz	0.00Hz	×
F04.16	Acceleration time 2	1~60000	1	200	○
F04.17	Deceleration time 2	1~60000	1	200	○
F04.18	Acceleration time 3	1~60000	1	200	○
F04.19	Deceleration time 3	1~60000	1	200	○
F04.20	Acceleration time 4	1~60000	1	200	○
F04.21	Deceleration time 4	1~60000	1	200	○
F04.22	Acceleration time 5	1~60000	1	200	○
F04.23	Deceleration time 5	1~60000	1	200	○
F04.24	Acceleration time 6	1~60000	1	200	○
F04.25	Acceleration time 6	1~60000	1	200	○
F04.26	Acceleration time 7	1~60000	1	200	○
F04.27	Deceleration time 7	1~60000	1	200	○
F04.28	Acceleration time 8	1~60000	1	200	○
F04.29	Deceleration time 8	1~60000	1	200	○
F04.30	Acceleration time 9	1~60000	1	200	○
F04.31	Deceleration time 9	1~60000	1	200	○
F04.32	Acceleration time 10	1~60000	1	200	○
F04.33	Deceleration time 10	1~60000	1	200	○
F04.34	Acceleration time 11	1~60000	1	200	○
F04.35	Deceleration time 11	1~60000	1	200	○
F04.36	Acceleration time 12	1~60000	1	200	○
F04.37	Deceleration time 12	1~60000	1	200	○
F04.38	Acceleration time 13	1~60000	1	200	○
F04.39	Deceleration time 13	1~60000	1	200	○
F04.40	Acceleration time 14	1~60000	1	200	○
F04.41	Deceleration time 14	1~60000	1	200	○
F04.42	Acceleration time 15	1~60000	1	200	○
F04.43	Deceleration time 15	1~60000	1	200	○

F05— Terminal correlative function parameter group

Function code	Name	Set range	Min. unit	Factory default	Modification
F05.00	protocol selection	0: Modbus protocol . 1: Reserved. 2: Profibus protocol. Extend effective 3: CanLink protocol. Extend effective 4: CanOpen protocol. Extend effective 5: Free protocol 1. 6: Free protocol 2.	1	0	×

F05.01	Baud rate configuration	LED units digit: Free protocol and Modbus Baud rate selection 0: 300BPS 1: 600BPS 2: 1200BPS 3: 2400BPS 4: 4800BPS 5: 9600BPS 6: 19200BPS 7: 38400BPS 8: 57600BPS LED tens digit: Reserved LED hundreds digit: CanLink Baud rate 0: 20K 1: 50K 2: 100K 3: 125K 4: 250K 5: 500K 6: 1M	1	005	×
F05.02	Data format	LED units digit: Free protocol and Modbus protocol data format 0: 1-8-1 format: no parity: RTU. 1: 1-8-1 format: even parity: RTU. 2: 1-8-1 format: odd parity: RTU. 3: 1-7-1 format: no parity: ASCII. 4: 1-7-1 format: even parity: ASCII. 5: 1-7-1 format: odd parity: ASCII. LED tens digit: Profibus_DP protocol data format 0:PPO1communication format 1:PPO2communication format 2:PPO3communication format 3:PPO5communication format		00	×
F05.03	Local address	0~247, this function code is used to identify inverter's address: among which 0 is broadcast address. When setting broadcast address: it can only receive and execute upper computer broadcast command: while cannot respond to upper computer.	1	1	×
F05.04	Communication overtime checkout time	0.0~1000.0s	0.1s	0.0s	○
F05.05	Communication error checkout time	0.0~1000.0s	0.1s	0.0s	○
F05.06	Local response delay time	0~200ms(Modbus effective)	1ms	5ms	○
F05.07	Main & sub inverter communication frequency setting percentage	0~500%	1%	100%	○

F05.08	Communication virtual input terminal enabled	00 ~ FFH Bit0: CX1 virtual input terminal enabled 0:forbidden 1:enabled Bit1: CX2 virtual input terminal enabled 0:forbidden 1:enabled Bit2: CX3 virtual input terminal enabled 0:forbidden 1:enabled Bit3: CX4 virtual input terminal enabled 0:forbidden 1:enabled Bit4: CX5 virtual input terminal enabled 0:forbidden 1:enabled Bit5: CX6 virtual input terminal enabled 0:forbidden 1:enabled Bit6: CX7 virtual input terminal enabled 0:forbidden 1:enabled Bit7: CX8 virtual input terminal enabled 0:forbidden 1:enabled	1	00H	○
F05.09	Communication virtual input terminal joining node	0: Independent node. 1: Terminal node.	1	0	○
F05.10	Communication virtual terminal CX1 function	0~90	1	0	○
F05.11	Communication virtual terminal CX2 function	0~90	1	0	○
F05.12	Communication virtual terminal CX3 function	0~90	1	0	○
F05.13	Communication virtual terminal CX4 function	0~90	1	0	○
F05.14	Communication virtual terminal CX5 function	0~90	1	0	○
F05.15	Communication virtual terminal CX6 function	0~90	1	0	○
F05.16	Communication virtual terminal CX7 function	0~90	1	0	○
F05.17	Communication virtual terminal CX8 function	0~90	1	0	○
F05.18	Input mapping application parameter 1	F00.00~F26.xx	0.01	25.00	○
F05.19	Input mapping application parameter 2	F00.00~F26.xx	0.01	25.00	○
F05.20	Input mapping application parameter 3	F00.00~F26.xx	0.01	25.00	○
F05.21	Input mapping application parameter 4	F00.00~F26.xx	0.01	25.00	○
F05.22	Input mapping application parameter 5	F00.00~F26.xx	0.01	25.00	○
F05.23	Input mapping application parameter 6	F00.00~F26.xx	0.01	25.00	○

F05.24	Input mapping application parameter 7	F00.00~F26.xx	0.01	25.00	○
F05.25	Input mapping application parameter 8	F00.00~F26.xx	0.01	25.00	○
F05.26	Input mapping application parameter 9	F00.00~F26.xx	0.01	25.00	○
F05.27	Input mapping application parameter 10	F00.00~F26.xx	0.01	25.00	○
F05.28	Reserved				
F05.29	Reserved				
F05.30	Reserved				
F05.31	Reserved				
F05.32	Reserved				
F05.33	Reserved				
F05.34	Reserved				
F05.35	Reserved				
F05.36	Reserved				
F05.37	Reserved				
F05.38	Reserved				
F05.39	Reserved				

F06— Traverse special function parameter group

Function code	Name	Set range	Min. unit	Factory default	Modification
F06.00	Setting curve selection	LED units digit: All curve selection 0: curve 1 1: curve 2 2: curve 3 LED tens digit: AI2 curve selection Same as unit's digit. LED hundreds digit: apid pulse curve selection Same as unit's digit. LED thousands digit: Pulse width setting curve selection Same as unit's digit.	1	0000	○
F06.01	Curve 1 min. setting	0.0%~curve 1 inflexion setting	0.1%	0.0%	○
F06.02	Corresponding physical quantity of curve 1 min. setting	0.0~100.0%	0.1%	0.0%	○
F06.03	Curve 1 inflexion setting	Curve 1 min. setting ~ curve 1 Max.	0.1%	50.0%	○
F06.04	Corresponding physical quantity of curve 1 inflexion setting	0.0~100.0%	0.1%	50.0%	○
F06.05	Curve 1 Max. setting	Curve 1 inflexion setting ~ 100.0%, 100.0% iscorresponding to 5V Input AD terminal	0.1%	100.0%	○
F06.06	Corresponding physical quantity of	0.0~100.0%	0.1%	100.0%	○

	curve 1 Max. setting				
F06.07	Curve 2 min. setting	0.0% ~ curve 2 inflexion setting	0.1%	0.0%	○
F06.08	Corresponding physical quantity of curve 2 min. setting	0.0~100.0%	0.1%	0.0%	○
F06.09	Curve 2 inflexion setting	Curve 2 min. setting ~ curve 2 Max. setting	0.1%	50.0%	○
F06.10	Corresponding physical quantity of curve 2 inflexion setting	0.0~100.0%	0.1%	50.0%	○
F06.11	Curve 2 Max. setting	Curve 2 inflexion setting ~ 100.0%	0.1%	100.0%	○
F06.12	Corresponding physical quantity of curve 2 Max. setting	0.0~100.0%	0.1%	100.0%	○
F06.13	Curve 3 min. setting	0.0% ~ curve 3 inflexion 1 setting	0.1%	0.0%	○
F06.14	Corresponding physical quantity of curve 3 min. setting	0.0~100.0%	0.1%	0.0%	○
F06.15	Curve 3 inflexion 1 setting	Curve 3 min. setting ~ curve 3 inflexion 2 setting	0.1%	30.0%	○
F06.16	Corresponding physical quantity of curve 3 inflexion 1 setting	0.0~100.0%	0.1%	30.0%	○
F06.17	Curve 3 inflexion 2 setting	Curve 3 inflexion 1 setting ~ curve 3 Max. setting	0.1%	60.0%	○
F06.18	Corresponding physical quantity of curve 3 inflexion 2 setting	0.0~100.0%	0.1%	60.0%	○
F06.19	Curve 3 Max. setting	Curve 3 inflexion 1 setting ~ 100.0%	0.1%	100.0%	○
F06.20	Corresponding physical quantity of curve 3 Max. setting	0.0~100.0%	0.1%	100.0%	○
F06.21	Curve lower than min. input corresponding selection	LED units digit: curve 1 setting 0: Corresponds to min. setting corresponding physical quantity. 1: 0.0% of the corresponding physical quantity. LED tens digit: curve 2 setting Same as units digit. LED hundreds digit: curve 3 setting Same as units digit. LED thousands digit: extended curve 1 Same as units digit. LEDten thousands digit: extended curve 2 Same as units digit.	1	11111	○

F07—Analog quantity, Pulse input function parameter group					
Function code	Name	Set range	Min. unit	Factory default	Modification
F07.00	A11 input filter time	0.000~9.999s	0.001s	0.050s	×
F07.01	A11 setting gain	0.000~9.999	0.001	1.004	○
F07.02	A11 setting bias	0.0~100.0%	0.1%	0.5%	○
F07.03	A12 input filter time	0.000~9.999s	0.001	0.050s	×
F07.04	A12 setting gain	0.000~9.999	0.001	1.003	○
F07.05	A12 setting bias	0.0~100.0%	0.1%	0.1%	○
F07.06	Analog setting bias polarity	LED units digit: A11 setting bias polarity 0: Positive polarity. 1: Negative polarity. LED tens digit: A12 setting bias polarity 0: Positive polarity. 1: Negative polarity.	1	01	○
F07.07	Pulse input filter time	0.000~9.999s	0.001	0.000s	×
F07.08	Pulse input gain	0.000~9.999	0.001	1.000	○
F07.09	Pulse input Max. frequency	0.01~50.00KHz	0.01KHz	10.00KHz	○
F07.10	Pulse width input filter time	0.000~9.999s	0.001s	0.000s	×
F07.11	Pulse width input gain	0.000~9.999	0.001	1.000	○
F07.12	Pulse width input logic setting.	0: positive logic 1: negative logic	1	0	○
F07.13	Pulse width Max. input width	0.1~999.9ms	0.1ms	100.0ms	○
F07.14	Reserved				
F07.15	Reserved				
F07.16	Reserved				
F07.17	Reserved				

F08—On-off input function parameter group					
Function code	Name	Set range	Min. unit	Factory default	Modification
F08.00	Input terminal positive and negative logic setting	0000~FFFF(include extral input terminal)	1	0000	○
F08.01	Input terminal filter time	0.000~1.000s(suitable for extral input terminal)	0.001s	0.000s	○
F08.02	X1 Input terminal closed time	0.00~99.99s	0.01s	0.00s	○
F08.03	X1 Input terminal opened time	0.00~99.99s	0.01s	0.00s	○
F08.04	X2 Input terminal closed time	0.00~99.99s	0.01s	0.00s	○
F08.05	X2 Input terminal opened time	0.00~99.99s	0.01s	0.00s	○
F08.06	X3 Input terminal closed time	0.00~99.99s	0.01s	0.00s	○
F08.07	X3 Input terminal opened time	0.00~99.99s	0.01s	0.00s	○
F08.08	X4 Input terminal	0.00~99.99s	0.01s	0.00s	○

	closed time				
F08.09	X4 Input terminal opened time	0.00~99.99s	0.01s	0.00s	○
F08.10	X5 Input terminal closed time	0.00~99.99s	0.01s	0.00s	○
F08.11	X5 Input terminal opened time	0.00~99.99s	0.01s	0.00s	○
F08.12	X6 Input terminal closed time	0.00~99.99s	0.01s	0.00s	○
F08.13	X6 Input terminal opened time	0.00~99.99s	0.01s	0.00s	○
F08.14	X7 Input terminal closed time	0.00~99.99s	0.01s	0.00s	○
F08.15	X7 Input terminal opened time	0.00~99.99s	0.01s	0.00s	○
F08.16	X8 Input terminal closed time	0.00~99.99s	0.01s	0.00s	○
F08.17	X8 Input terminal opened time	0.00~99.99s	0.01s	0.00s	○
F08.18	Input terminal X1 function selection	0: Leave control terminal unused 1: Forward running FWD terminal 2: Reverse running REV terminal 3: External forward jogging control 4: External reverse jogging control 5: Multi-step speed control terminal 1 6: Multi-step speed control terminal 2 7: Multi-step speed control terminal 3 8: Multi-step speed control terminal 4 9: Acceleration/deceleration time selection terminal 1 10: Acceleration/deceleration time selection terminal 2 11: Acceleration/deceleration time selection terminal 3 12: Acceleration/deceleration time selection terminal 4 13: Main and auxiliary frequency operational rule selection terminal 1 14: Main and auxiliary frequency operational rule selection terminal 2 15: Main and auxiliary frequency operational rule selection terminal 3 16: Frequency ascending command (UP) 17: Frequency descending command (DOWN) 18: Frequency ascending/descending frequency resetting 19: Multi-step closed loop terminal 1 20: Multi-step closed loop terminal 2 21: Multi-step closed loop terminal 3 22: External equipment failure input 23: external interruption input 24: external resetting input 25: Free stop input 26: External stop instruction—Stop according to the stop mode 27: stop DC braking input command DB	1	1	×

		<p>28:inverter running prohibited—Stop according to the stop mode</p> <p>29:Acceleration/deceleration prohibited command</p> <p>30: Three-wire running control</p> <p>31: Process PID invalid</p> <p>32:Process PID stop</p> <p>33: Process PID integral holding</p> <p>34:Process PID integral resetting</p> <p>35:Process PID function negation(Closed loop adjustment feature negation)</p> <p>36: simple PLC invalid</p> <p>37: simple PLC halted</p> <p>38: simple PLC stop state resetting</p> <p>39: main frequency switchover to digit (keypad)</p> <p>40: main frequency switchover to AI1</p> <p>41: main frequency switchover to AI2</p> <p>42: main frequency switchover to EA11</p> <p>43: main frequency switchover to EA12</p> <p>44: main frequency setting channel selection terminal 1</p> <p>45: main frequency setting channel selection terminal 2</p> <p>46: main frequency setting channel selection terminal 3</p> <p>47: main frequency setting channel selection terminal 4</p> <p>48: Auxiliary frequency reset</p> <p>49: Command switchover to panel</p> <p>50: Command switchover to terminal</p> <p>51: Command switchover to communication</p> <p>52:Running command Channel selection terminal 1</p> <p>53:Running command Channel selection terminal 2</p> <p>50:Forward prohibited command(Stop according to the stop mode: invalid for jogging command)</p> <p>55:Reverse prohibited command (Stop according to the stop mode: invalid for jogging command)</p> <p>56:Swinging frequency input</p> <p>57:Resetting state of swinging frequency</p> <p>58:Interior counter reset end</p> <p>59:Interior counter input end</p> <p>60:Internal timer resetting</p> <p>61:Internal timer triggering</p> <p>62:Length count input</p> <p>63:Length reset</p> <p>64:Reset this operation time</p> <p>65~90:Reserved</p> <p>91:Pulse frequency input (X8 VALID)</p> <p>92:Pulse width PWM INPUT (X8 VALID)</p> <p>93~95:Reserved</p>			
F08.19	Input terminal X2 function selection	Same as above	1	2	×

F08.20	Input terminal X3 function selection	Same as above	1	0	×
F08.21	Input terminal X4 function selection	Same as above	1	0	×
F08.22	Input terminal X5 function selection	Same as above	1	0	×
F08.23	Input terminal X6 function selection	Same as above	1	0	×
F08.24	Input terminal X7 function selection	Same as above	1	0	×
F08.25	Input terminal X8 function selection	Same as above	1	0	×
F08.26	FWD/REV operating mode selection	0: Two-wire control mode 1 1: Two-wire control mode 2 2: Two-wire control mode 3 (monopulse control mode) 3: Three-wire control mode 1 4: Three-wire control mode 2	1	0	×
F08.27	Set internal count value to setting	0~65535	1	0	○
F08.28	Specify internal count to setting	0~65535	1	0	○
F08.29	Internal timer timing setting	0.1~6000.0s	0.1	60.0s	○
F08.30	Terminal pulse encoder frequency rate	0.01 ~ 10.00Hz(only be effective by given X1:X2 encoder)	0.01Hz	1.00Hz	○
F08.31	Reserved				

F09—Output Terminal Corrective Functions

Function code	Name	Set range	Min. unit	Factory default	Modification
F09.00	Open collector output terminal Y1 output setup	0:terminal unused 1:operation(RUN) 2:CW run 3:CCW run 4:DC brake 5:run prepare finish(busbar voltage normal, fault free,no run forbid, receipt of run command's status) 6:stop command indication 7:no current detected 8:overcurrent detected 9:current1 arrival 10:current2 arrival 11:no frequency output 12:frequency arrival signal(FAR) 13:frequency level detect signal 1(FDT1) 14:frequency level detect signal 2(FDT2) 15:output frequency arrival upper limit(FHL) 16:output frequency arrival low limit(FLL) 17:frequency 1 arrival output	1	0	×

	<p>18:frequency 2 arrival output 19:overload pre-alarm signal(OL) 20:undervoltage lockout stop (LU) 21:external fault stop(EXT) 22:fault 23:alarm 24:simple PLC operation 25:simple PLC section operation finish 26:simple PLC circle operation finish 27:simple PLC operation stop 28:traverse frequency high and low limit 29:setup length arrival 30:internal counter final value arrival 31:internal counter designated value arrival 32:internal timer arrival---output 0.5s valid signal on arrival 33:operation stop time finish 34:operation arrival time finish 35:setup run time arrival 36:setup power on time arrival 37:1st pump variable frequency 38:1st pump power frequency 39:2nd pump variable frequency 40:2nd pump power frequency 41:communication provision 42~60:reserve0:terminal unused</p> <p>1:operation(RUN) 2:CW run 3:CCW run 4:DC brake 5:run prepare finish(busbar voltage normal, fault free,no run forbid, receipt of run command's status) 6:stop command indication 7:no current detected 8:overcurrent detected 9:current1 arrival 10:current2 arrival 11:no frequency output 12:frequency arrival signal(FAR) 13:frequency level detect signal 1(FDT1) 14:frequency level detect signal 2(FDT2) 15:output frequency arrival upper limit(FHL) 16:output frequency arrival low limit(FLL) 17:frequency 1 arrival output 18:frequency 2 arrival output 19:overload pre-alarm signal(OL) 20:undervoltage lockout stop (LU) 21:external fault stop(EXT) 22:fault 23:alarm 24:simple PLC operation</p>			
--	--	--	--	--

		25:simple PLC section operation finish 26:simple PLC circle operation finish 27:simple PLC operation stop 28:traverse frequency high and low limit 29:setup length arrival 30:internal counter final value arrival 31:internal counter designated value arrival 32:internal timer arrival---output 0.5s valid signal on arrival 33:operation stop time finish 34:operation arrival time finish 35:setup run time arrival 36:setup power on time arrival 37:1 st pump variable frequency 38:1 st pump power frequency 39:2 nd pump variable frequency 40:2 nd pump power frequency 41:communication provision 42~60: Reserved			
F09.01	Open collector output terminal Y2 output setup	Same as above	1	0	×
F09.02	Open collector output terminal Y3 output setup	Same as above	1	0	×
F09.03	Open collector output terminal Y4 output setup	Same as above	1	0	×
F09.04	Programmable relay output setup	Same as above	1	22	×
F09.05	Frequency arrival(FAR)detection range	0.00~50.00Hz	0.01Hz	5.00Hz	○
F09.06	FDT1 (frequency level)level	0.00Hz~upper limit frequency	0.01Hz	10.00Hz	○
F09.07	FDT1 lag	0.00~50.00Hz	0.01Hz	1.00Hz	○
F09.08	FDT2 (frequency level)level	0.00Hz~upper limit frequency	0.01Hz	10.00Hz	○
F09.09	FDT2 lag	0.00~50.00Hz	0.01Hz	1.00Hz	○
F09.10	Zero frequency signal detection value	0.00Hz~upper limit frequency	0.01Hz	0.00Hz	○
F09.11	Zero frequency return difference	0.00Hz~upper limit frequency	0.01Hz	0.00Hz	○
F09.12	Zero-current detection range	0.0~50.0%	0.1%	0.0%	○
F09.13	Zero-current detection time	0.00~60.00s	0.01s	0.1s	○
F09.14	Over-current detection value	0.0~250.0%	0.1%	160.0%	○
F09.15	Over-current detection time	0.00~60.00s	0.01s	0.00s	○
F09.16	Current 1 arrival detection value	0.0~250.0%	0.1%	100.0%	○
F09.17	Current 1 width	0.0~100.0%	0.1%	0.0%	○
F09.18	Current 2 arrival	0.0~250.0%	0.1%	100.0%	○

	detection value				
F09.19	Current 2 width	0.0~100.0%	0.1%	0.0%	○
F09.20	Frequency 1 arrival detection value	0.00Hz~upper limit frequency	0.01Hz	50.00Hz	○
F09.21	Frequency 1 arrival detection width	0.00Hz~upper limit frequency	0.01Hz	0.00Hz	○
F09.22	Frequency 2 arrival detection value	0.00Hz~upper limit frequency	0.01Hz	50.00Hz	○
F09.23	Frequency 2 arrival detection width	0.00Hz~upper limit frequency	0.01Hz	0.00Hz	○
F09.24	Output terminal positive and negative logic setup	0000~FFFF(extension valid)	1	0000	○
F09.25	Y1 output open delay time	0.000~50.000s	0.001s	0.000s	○
F09.26	Y1 output close delay time	0.000~50.000s	0.001s	0.000s	○
F09.27	Y2 output open delay time	0.000~50.000s	0.001s	0.000s	○
F09.28	Y2 output close delay time	0.000~50.000s	0.001s	0.000s	○
F09.29	Y3 output open delay time	0.000~50.000s	0.001s	0.000s	○
F09.30	Y3 output close delay time	0.000~50.000s	0.001s	0.000s	○
F09.31	Y4 output open delay time	0.000~50.000s	0.001s	0.000s	○
F09.32	Y4 output close delay time	0.000~50.000s	0.001s	0.000s	○
F09.33	Relay output close delay time	0.000~50.000s	0.001s	0.000s	○
F09.34	Relay output turn-off delay time	0.000~50.000s	0.001s	0.000s	○
F09.35	Analog output(AO1) selection	0:output frequency before slip compensation(0.00Hz~upper limit frequency) 1:output frequency after slip compensation(0.00Hz~upper limit frequency) 2:Setup frequency(0.00Hz~upper limit frequency) 3:main setting frequency(0.00Hz~upper limit frequency) 4:auxiliary setting frequency(0.00Hz~upper limit frequency) 5:output current 1(0~2×inverter rated current) 6:output current 2(0~3×motor rated current) 7:output voltage(0~1.2×load motor rated voltage) 8:busbar voltage(0~1.5×rated busbar voltage) 9:motor speed(0~3 rated speed) 10:PID provision(0.00~10.00V) 11:PID feedback(0.00~10.00V)	1	0	○

		12:A11(0.00~10.00V or 4~20mA) 13:A12(-10.00~10.00V or 4~20mA) 14:communication provision 15~25: Reserved			
F09.36	Analog output(AO2) selection	Same as above	1	0	○
F09.37	DO function selection(with Y4 reuse)	Same as above	1	0	○
F09.38	Reserved				
F09.39	Analog output(AO1) filter time	0.0~20.0s	0.1s	0.0s	○
F09.40	Analog output(AO1) gain	0.00~2.00	0.01	1.00	○
F09.41	Analog output(AO1) bias	0.0~100.0%	0.1%	0.0%	○
F09.42	Analog output(AO2) filter time	0.0~20.0s	0.1s	0.0s	○
F09.43	Analog output(AO2) gain	0.00~2.00	0.01	1.00	○
F09.44	Analog output(AO2) bias	0.0~100.0%(AO2 output terminal with Y3 reuse)	0.1%	0.0%	○
F09.45	DO filter time	0.0~20.0s	0.1s	0.0s	○
F09.46	DO output gain	0.00~2.00	0.01	1.00	○
F09.47	DO maximum pulse output frequency	0.1~20.0KHz	0.1KHz	10.0KHz	○
F09.48	Reserved				
F09.49	Reserved				
F09.50	Reserved				

F10— Simple PLC/Multi-speed Function Parameter Group

Function code	Name	Set range	Min. unit	Factory default	Modification
F10.00	Simple PLC run setup	LED units digit: run mode selection 0:inaction 1:stop after single cycle 2:final value keep after single cycle 3:continuous cycle LED tens digit: interrupt run restart mode selection 0:restart from first phase 1:continuous run from phase frequency at interruption 2:continuous run from run frequency at interruption LED hundreds digit: PLC run time unit 0:second 1:minute LED thousands digit: power-down memory selection 0:no memory 1:phase of reserve power down,frequency power down recording PLC run status: contain power down phase, run frequency, time have run.	1	0000	×

F10.01	Phase 1 setup	000H~E22H LED units digit: frequency setup 0:multistage frequency i (i=1~15) 1:frequency determined by complex frequency of main and auxiliary 2: Reserved LED tens digit: operation direction selection 0:forward 1:reversal 2:determine by run command LED hundreds digit: ACC/DEC time selection 0:ACC/DEC time 1 1:ACC/DEC time 2 2:ACC/DEC time 3 3:ACC/DEC time 4 4:ACC/DEC time 5 5:ACC/DEC time 6 6:ACC/DEC time 7 7:ACC/DEC time 8 8:ACC/DEC time 9 9:ACC/DEC time 10 A:ACC/DEC time 11 B:ACC/DEC time 12 C:ACC/DEC time 13 D:ACC/DEC time 14 E:ACC/DEC time 15	1	000	○
F10.02	Phase 2 setup	000H~E22H	1	000	○
F10.03	Phase 3setup	000H~E22H	1	000	○
F10.04	Phase 4 setup	000H~E22H	1	000	○
F10.05	Phase 5 setup	000H~E22H	1	000	○
F10.06	Phase 6 setup	000H~E22H	1	000	○
F10.07	Phase 7 setup	000H~E22H	1	000	○
F10.08	Phase 8 setup	000H~E22H	1	000	○
F10.09	Phase 9 setup	000H~E22H	1	000	○
F10.10	Phase 10 setup	000H~E22H	1	000	○
F10.11	Phase 11 setup	000H~E22H	1	000	○
F10.12	Phase 12 setup	000H~E22H	1	000	○
F10.13	Phase 13 setup	000H~E22H	1	000	○
F10.14	Phase 14 setup	000H~E22H	1	000	○
F10.15	Phase 15 setup	000H~E22H	1	000	○
F10.16	Phase 1 run time	0~6000.0	0.1	10.0	○
F10.17	Phase 2 run time	0~6000.0	0.1	10.0	○
F10.18	Phase 3 run time	0~6000.0	0.1	10.0	○
F10.19	Phase 4 run time	0~6000.0	0.1	10.0	○
F10.20	Phase 5 run time	0~6000.0	0.1	10.0	○
F10.21	Phase 6 run time	0~6000.0	0.1	10.0	○
F10.22	Phase 7 run time	0~6000.0	0.1	10.0	○
F10.23	Phase 8 run time	0~6000.0	0.1	10.0	○
F10.24	Phase 9 run time	0~6000.0	0.1	10.0	○
F10.25	Phase 10 run time	0~6000.0	0.1	10.0	○
F10.26	Phase 11 run time	0~6000.0	0.1	10.0	○
F10.27	Phase 12 run time	0~6000.0	0.1	10.0	○
F10.28	Phase 13 run time	0~6000.0	0.1	10.0	○
F10.29	Phase 14 run time	0~6000.0	0.1	10.0	○

F10.30	Phase 15 run time	0~6000.0		0.1	10.0	○
F10.31	Multisection frequency 1	Low limit frequency	frequency~upper limit	0.01Hz	5.00Hz	○
F10.32	Multisection frequency 2	Low limit frequency	frequency~upper limit	0.01Hz	10.00Hz	○
F10.33	Multisection frequency 3	Low limit frequency	frequency~upper limit	0.01Hz	20.00Hz	○
F10.34	Multisection frequency 4	Low limit frequency	frequency~upper limit	0.01Hz	30.00Hz	○
F10.35	Multisection frequency 5	Low limit frequency	frequency~upper limit	0.01Hz	40.00Hz	○
F10.36	Multisection frequency 6	Low limit frequency	frequency~upper limit	0.01Hz	45.00Hz	○
F10.37	Multisection frequency 7	Low limit frequency	frequency~upper limit	0.01Hz	50.00Hz	○
F10.38	Multisection frequency 8	Low limit frequency	frequency~upper limit	0.01Hz	5.00Hz	○
F10.39	Multisection frequency 9	Low limit frequency	frequency~upper limit	0.01Hz	10.00Hz	○
F10.40	Multisection frequency 10	Low limit frequency	frequency~upper limit	0.01Hz	20.00Hz	○
F10.41	Multisection frequency 11	Low limit frequency	frequency~upper limit	0.01Hz	30.00Hz	○
F10.42	Multisection frequency 12	Low limit frequency	frequency~upper limit	0.01Hz	40.00Hz	○
F10.43	Multisection frequency 13	Low limit frequency	frequency~upper limit	0.01Hz	45.00Hz	○
F10.44	Multisection frequency 14	Low limit frequency	frequency~upper limit	0.01Hz	50.00Hz	○
F10.45	Multisection frequency 15	Low limit frequency	frequency~upper limit	0.01Hz	50.00Hz	○

F11—close loop PID run function parameter group

Function code	Name	Set range	Min. unit	Factory default	Modification
F11.00	Close loop run control selection	0:PID close loop run control invalid 1:PID close loop run control valid	1	0	×
F11.01	Provide channel selection	0:digital provide 1:A11 analog provide 2:A12 analog provide 3:EAI1 analog provide 4:EAI2 analog provide 5:pulse provide 6:communication provide 7:keyboard analog potentiometer setup (analog potentiometer keyboard in optional accessories)	1	0	○
F11.02	Feedback channel selection	0:A11 analog input 1:A12 analog input 2:EAI1 analog input 3:EAI2 analog input 4:A11+A12 5:A11-A12 6:Min {A11, A12}	1	0	○

		7:Max {AI1, AI2} 8:pulse input			
F11.03	Provide channel filtering time	0.01~50.00s	0.01s	0.20s	×
F11.04	Feedback channel filtering time	0.01~50.00s	0.01s	0.10s	×
F11.05	PID output filtering time	0.00~50.00s	0.01s	0.00s	○
F11.06	Provide digital setup	0.00~10.00V	0.01V	1.00V	○
F11.07	Proportional gain Kp	0.000~9.999	0.001	0.150	○
F11.08	Integral gain Ki	0.000~9.999	0.001	0.150	○
F11.09	Differential gain Kd	0.000~9.999	0.001	0.000	○
F11.10	Sample period T	0.01~1.00s	0.01s	0.10s	○
F11.11	Deviation range	0.0~20.0% correspond to provide value percentage	0.1%	2.0%	○
F11.12	PID differential range	0.00~100.00%	0.01%	0.10%	○
F11.13	Close-loop adjust characteristic	0:action 1:reaction	1	0	○
F11.14	Feedback channel plus-minus characteristic	0:plus characteristic 1:minus characteristic	1	0	○
F11.15	PID adjusting upper limit frequency	Low limit frequency~upper limit frequency	0.01Hz	50.00Hz	○
F11.16	PID adjusting low limit frequency	Low limit frequency~upper limit frequency	0.01Hz	0.00Hz	○
F11.17	Integral adjusting selection	0:when integral arrival separate PID threshold value, stop integral adjusting 1:when integral arrival separate PID threshold value, continue threshold value adjusting	1	0	○
F11.18	Integral separate PID threshold value	0.0~100.0%	0.1%	100.0%	○
F11.19	Close-loop preset frequency	Low limit frequency~upper limit frequency	0.01Hz	0.00Hz	○
F11.20	Close-loop preset frequency keep time	0.0~6000.0s	0.1s	0.0s	○
F11.21	Close-loop output changeover selection	0:close-loop output minus, low limit frequency run. 1:close-loop output minus, reverse run (effect by run direction setting)	1	0	○
F11.22	Close-loop output frequency maximum value	0.00Hz~upper limit frequency	0.01Hz	50.00Hz	○
F11.23	Multisection close-loop provide 1	0.00~10.00V	0.01V	0.00V	○
F11.24	Multisection close-loop provide 2	0.00~10.00V	0.01V	0.00V	○
F11.25	Multisection close-loop provide 3	0.00~10.00V	0.01V	0.00V	○
F11.26	Multisection close-loop provide 4	0.00~10.00V	0.01V	0.00V	○
F11.27	Multisection close-loop provide 5	0.00~10.00V	0.01V	0.00V	○
F11.28	Multisection close-loop provide 6	0.00~10.00V	0.01V	0.00V	○

F11.29	Multisection close-loop provide 7	0.00~10.00V	0.01V	0.00V	○
--------	-----------------------------------	-------------	-------	-------	---

F12— Constant Pressure Water Supply Function Parameter Group

Function code	Name	Set range	Min. unit	Factory default	Modification
F12.00	Constant pressure water supply mode selection	0:no constant pressure water supply 1:select inverter to achieve one drive two mode 2:select extend board to achieve one drive two mode 3:select extend board to achieve one drive three mode 4:select extend board to achieve one drive four mode	1	0	×
F12.01	Target pressure setup	0.000~long-distance pressure gage range	0.001Mpa	0.200Mpa	○
F12.02	Sleep frequency minimum value	0.00Hz~upper limit frequency	0.01Hz	30.00Hz	○
F12.03	Awake pressure minimum value	0.000~long-distance pressure gage range	0.001Mpa	0.150Mpa	○
F12.04	Sleep delay time	0.0~6000.0s	0.1s	0.0s	○
F12.05	Awake delay time	0.0~6000.0s	0.1s	0.0s	○
F12.06	long-distance pressure gage range	0.001~9.999Mpa	0.001Mpa	1.000Mpa	○
F12.07	Allowed aviation of upper limit frequency and low limit frequency: when add or decrease pump	0.1~100.0%	0.1%	1.0%	○
F12.08	Pump switching estimate time	0.0~999.9s	0.1s	5.0s	○
F12.09	Electromagnetism switch converter delay time	0.1~10.0s	0.1s	0.5s	○
F12.10	Automatically switching time interval	0000~9999 minute	1	0	×
F12.11	Reserved				
F12.12	Reserved				
F12.13	Reserved				
F12.14	Reserved				

F13— Traverse/ Fixed Length Control Function Parameter Group

Function code	Name	Set range	Min. unit	Factory default	Modification
F13.00	Traverse function enable	0:traverse invalid 1:traverse valid	1	0	×
F13.01	Traverse run mode	LED units digit: enter mode 0:automatically enter 1:terminal enter manually LED tens digit: 0:variable swing 1:fixed swing LED hundreds digit: traverse halt start	1	0000	×

		mode selection 0:restart 1:start as previous halt record LED thousands digit: traverse status reserve selection 0:no reserve 1:reserve			
F13.02	Traverse frequency swing value	0.0~50.0%	0.1%	10.0%	○
F13.03	Jump frequency	0.0~50.0%	0.1%	2.0%	○
F13.04	Traverse cycle	0.1~999.9s	0.1s	10.0s	○
F13.05	Triangular wave up time	0.0~98.0% (traverse cycle)	0.1%	50.0%	○
F13.06	Traverse preset frequency	0.00~400.00Hz	0.01Hz	0.00Hz	○
F13.07	Traverse preset frequency waiting time	0.0~6000.0s	0.1s	0.0s	○
F13.08	Setup length	0~65535m	1m	0m	○
F13.09	Pulse No. of axis per circle	1~10000	1	1	○
F13.10	Axis perimeter	0.01~100.00cm	0.01cm	10.00cm	○
F13.11	Reserved				
F13.12	Length correction coefficient	0.001~1.000	0.001	1.000	○
F13.13	After length arrival: record length manage	0:automatically reset 1:no change	0	1	○
F13.14	When stop: record length manage	0:automatically reset 1:no change	0	1	○

F14—Velocity Control Parameter Group

Function code	Name	Set range	Min. unit	Factory default	Modification
F14.00	Velocity ring proportional gain	0.010~6.000	0.001	0.700	○
F14.01	Velocity ring integral time constant	0.010~9.999	0.001	0.360	○
F14.02	Torque limit value	50.0~200.0%	0.1%	150.0%	○
F14.03	Motor stability coefficient	10~300	1	100	○
F14.04	Suppression vibration low limit frequency	0.00~2.00Hz	0.01Hz	0.50Hz	○
F14.05	Suppression vibration upper limit frequency	8.50~35.00Hz	0.01Hz	12.50Hz	○
F14.06	Suppression vibration compensation gain	100.0~130.0%	0.1%	100.0%	○
F14.07	Reserved				
F14.08	Reserved				
F14.09	Reserved				
F14.10	Reserved				
F14.11	Reserved				
F14.12	Reserved				
F14.13	Reserved				

F14.14	Reserved				
F14.15	Reserved				
F14.16	Reserved				
F14.17	Reserved				
F14.18	Reserved				
F14.19	Reserved				
F14.20	Reserved				
F14.21	Reserved				
F14.22	Reserved				
F14.23	Reserved				
F14.24	Reserved				
F14.25	Reserved				

F15—Asynchronous Motor Parameter Group					
Function code	Name	Set range	Min. unit	Factory default	Modification
F15.00	Asynchronous motor rated power	0.1~999.9KW	0.1KW	Base on motor type	×
F15.01	Asynchronous motor rated voltage	1~690V	1V	Base on motor type	×
F15.02	Asynchronous motor rated current	0.1~999.9A	0.1A	Base on motor type	×
F15.03	Asynchronous motor rated frequency	0.00~400.00Hz	0.01Hz	Base on motor type	×
F15.04	Asynchronous motor rated speed	0~60000r/min	1r/min	Base on motor type	×
F15.05	Asynchronous motor poles No.	1~7	1	2	×
F15.06	Asynchronous motor stator resistance	0.0000~6.5535Ω	0.0001	Base on motor type	×
F15.07	Asynchronous motor rotor resistance	0.000~6.5535Ω	0.0001	Base on motor type	×
F15.08	Asynchronous motor leakage inductance	0.00~655.35mH	0.01mH	Base on motor type	×
F15.09	Asynchronous motor mutual inductance	0.00~655.35mH	0.01mH	Base on motor type	×
F15.10	Asynchronous motor no load current	0.01~655.35A	0.01A	Base on motor type	×
F15.11	Asynchronous motor parameter auto-tune	0: no action 1: static auto-tune 2: no load run auto-tune 3:Reserved	1	0	×

F16—Reserved Parameter Group 1					
Function code	Name	Set range	Min. unit	Factory default	Modification
F16.00~F16.29	Reserved				

F17—Reserved Parameter Group 2					
Function code	Name	Set range	Min. unit	Factory default	Modification
F17.00~F17.20	Reserved				

F18—Enhance Control Parameter Group					
Function code	Name	Set range	Min. unit	Factory default	Modification
F18.00	Operation panel control frequency binding	0:no binding 1:operation keyboard digital setup 2:A11 analog setup 3:A12 analog setup 4:terminal UP/DOWN adjusting setup 5:communication provide(Modbus and external bus use the same main frequency storage) 6:EAI1 analog setup(extension valid) 7:EAI2 analog setup(extension valid) 8:high speed pulse setup(X8 terminal need choose the relative function) 9:terminal pulse width setup(X8 terminal need choose the relative function) 10:terminal encoder provide(decide by X1, X2) 11:keyboard analog potentiometer setup (analog potentiometer keyboard accessories in option) 12~15:Reserved	1	0	○
F18.01	Terminal control frequency binding	Same as above	1	0	○
F18.02	Communication control frequency binding	Same as above	1	0	○
F18.03	Digital frequency integral function selection	LED units digit: keyboard UP/DW integral control 0:integral function 1:no integral function LED tens digit: terminal UP/DW integral control 0:integral function 1:no integral function	1	00	○
F18.04	Keyboard UP/DW integral rate	0.01~50.00Hz	0.01Hz	0.10Hz	○
F18.05	Keyboard no integral single step's size setup	0.01~10.00Hz	0.01Hz	0.01Hz	○

F18.06	Terminal UP/DW integral rate	0.01~50.00Hz	0.01Hz	0.20Hz	○
F18.07	Terminal no integral single step's size setup	0.01~10.00Hz	0.01Hz	0.10Hz	○
F18.08	Droop control decline frequency	0.00~10.00Hz	0.01Hz	0.00Hz	○
F18.09	Setup accumulate power on time	0~65535h	1	0	○
F18.10	Setup accumulate run time	0~65535h	1	0	○
F18.11	Setup run function enable	0:invalid 1:valid	1	0	○
F18.12	Setup run stop time	0.1~6500.0Min	0.1Min	2.0Min	○
F18.13	Currently run arrival time	0.0~6500.0Min	0.1Min	1.0Min	○
F18.14	Keyboard UP/DW selection under monitor mode	0:keyboard frequency provide value adjusting 1:PID digital provide value adjusting 2~6:Reserved	1	0	○
F18.15	Reserved				
F18.16	Reserved				
F18.17	Reserved				
F18.18	Reserved				
F18.19	Reserved				
F18.20	Reserved				
F18.21	Reserved				
F18.22	Reserved				
F18.23	Reserved				
F18.24	Reserved				

F19—Protective Relevant Function Parameter Group

Function code	Name	Set range	Min. unit	Factory default	Modification
F19.00	Power off restart waiting time	0.0~20.0s(0 means no start function)	0.1s	0.0s	×
F19.01	Fault self-recovery times	0~10(0 means no automatic reset function)	1	0	×
F19.02	Fault self-recovery interval time	0.5~20.0s	0.1s	5.0s	×
F19.03	Motor overload protection action selection	0:alarm: continuous run 1:alarm, stop run as halt mode 2:fault, free halt	1	2	×
F19.04	Motor overload protection coefficient	20.0~120.0%(motor rated current)	0.1%	100.0%	×
F19.05	Inverter overload pre-alarm detection selection	0: detection all the time. 1: enable only constant speed detection.	1	0	×
F19.06	Inverter overload pre-alarm detection level	20~180%(inverter rated current)	1%	130%	○
F19.07	Inverter overload pre-alarm delay time	0.0~20.0s	0.1s	5.0s	○
F19.08	Motor underload alarm detection level	0.0~120.0%(motor rated current)	0.1%	50.0%	○

F19.09	Motor underload alarm detection time	0.1~60.0s	0.1s	2.0s	○
F19.10	Motor underload alarm detection action	LED units digit: detection selection 0:no detection 1:detection all the time when run 2:detection only when constant velocity LED tens digit: action selection 0:alarm, continuous run 1:alarm, stop run as halt mode 2:fault, free halt	1	00	○
F19.11	Input&output phase loss,short circuit detection action	LED units digit: input phase loss 0:no detection 1:fault, free halt LED tens digit: output phase loss 0:no detection 1:fault, free halt LED hundreds digit: power-on on earth short circuit protect detection enable 0:no detection 1:fault, free halt LED thousands digit: operation on earth short circuit protect detection enable 0:no detection 1:fault, free halt	1	1111	○
F19.12	Overvoltage stall selection	0:forbid 1:allowed	1	1	×
F19.13	Overvoltage stall protection voltage	120~150%	1%	125%	×
F19.14	Automatic current limit level	110~200%, G type rated current	1%	150%	×
F19.15	Frequency decline rate of automatic current limit	0.00~99.99Hz/s	0.01Hz/s	10.00Hz/s	×
F19.16	Automatic current limit action selection	0:constant velocity invalid 1:constant velocity valid	1	0	×
F19.17	Reserved				
F19.18	Motor run section selection when instant power off	0:forbid 1:allowed	1	0	×
F19.19	Frequency droop rate when instant power off	0.00~99.99Hz/s	0.01Hz/s	10.00Hz/s	×
F19.20	Voltage rebound estimate time when instant power off	0.00~10.00s	0.01s	0.10s	×
F19.21	Action estimate voltage when instant power off	60~100%(rated busbar voltage)	1%	80%	×
F19.22	Allowed the longest off time when instant power off	0.30~5.00s	0.01s	2.00s	×
F19.23	Terminal external device fault action selection	0:alarm, continuous run 1:alarm, stop run as halt mode 2:fault, free halt	1	2	×
F19.24	Power on terminal protection selection	0:invalid 1:valid	1	1	×
F19.25	Provide lost detection	0~100%	1%	0%	○

	value				
F19.26	Provide lost detection time	0.0~20.0s	0.1s	0.5s	○
F19.27	Feedback lost detection value	0~100%	1%	12%	○
F19.28	Feedback lost detection time	0.0~20.0s	0.1s	0.5s	○
F19.29	Deviation magnitude abnormal detection value	0~100%	1%	50%	○
F19.30	Deviation magnitude abnormal detection time	0.0~20.0s	0.1s	0.5s	○
F19.31	Protection action selection 1	LED units digit: PID provide loss detection act 0:no detection 1:alarm, continue run 2:alarm, stop run as halt mode 3:fault, free halt LED tens digit: PID feedback loss detection act 0:no detection 1:alarm, continue run 2:alarm, stop run as halt mode 3:fault, free halt LED hundreds digit: PID error value abnormal detect action 0:no detection 1:alarm, continue run 2:alarm, stop run as halt mode 3:fault, free halt	1	000	○
F19.32	Protection action selection 2	LED units digit: communication abnormal action: include communication time out and error 0:alarm, continue run 1:alarm, stop run as halt mode 2:fault, free halt LED tens digit: E ² PROM abnormal action selection 0:alarm, continue run 1:alarm, stop run as halt mode 2:fault, free halt LED hundreds digit: contactor abnormal action 0:alarm, continue run 1:alarm, stop run as halt mode 2:fault, free halt LED thousands digit: under voltage fault indication action selection 0:no detection 1:fault, free halt	1	1200	×
F19.33	Reserved				
F19.34	Reserved				
F19.35	Fault indication and clock during the period of recovery	LED units digit: fault indication selection during the period of fault reset automatically	1	00	×

		0:action 1:no action LED tens digit: fault clock function selection: to achieve fault display before ower down: etc. 0:forbid 1:open			
F19.36	Continuous run frequency selection when alarm	Match up with protect action 0:run at the frequency setup by now 1:run at the frequency of upper limit 2:run at the frequency of low limit 3:run at the frequency of abnormal for standby	1	0	×
F19.37	Abnormal standby frequency	0.00Hz~upper limit frequency	0.01Hz	10.00Hz	×
F19.38	Reserved				
F19.39	Reserved				
F19.40	Reserved				
F19.41	Reserved				
F19.42	Reserved				
F19.43	Reserved				
F19.44	Reserved				

F20—Internal Virtual Input Output Node Parameter Group

Function code	Name	Set range	Min. unit	Factory default	Modification
F20.00	Virtual input VDI1 function selection	0~90	1	0	○
F20.01	Virtual input VDI2 function selection	0~90	1	0	○
F20.02	Virtual input VDI3 function selection	0~90	1	0	○
F20.03	Virtual input VDI4 function selection	0~90	1	0	○
F20.04	Virtual input VDI5 function selection	0~90	1	0	○
F20.05	Virtual output VDO1 function selection	0~60	1	0	○
F20.06	Virtual output VDO2 function selection	0~60	1	0	○
F20.07	Virtual output VDO3 function selection	0~60	1	0	○
F20.08	Virtual output VDO4 function selection	0~60	1	0	○
F20.09	Virtual output VDO5 function selection	0~60	1	0	○
F20.10	Virtual output VDO1 open delay time	0.00~600.00s	0.01s	0.00s	○
F20.11	Virtual output VDO2 open delay time	0.00~600.00s	0.01s	0.00s	○
F20.12	Virtual output VDO3 open delay time	0.00~600.00s	0.01s	0.00s	○
F20.13	Virtual output VDO4 open delay time	0.00~600.00s	0.01s	0.00s	○
F20.14	Virtual output VDO1	0.00~600.00s	0.01s	0.00s	○

	open delay time				
F20.15	Virtual output VDO1 close delay time	0.00~600.00s	0.01s	0.00s	○
F20.16	Virtual output VDO2 close delay time	0.00~600.00s	0.01s	0.00s	○
F20.17	Virtual output VDO3 close delay time	0.00~600.00s	0.01s	0.00s	○
F20.18	Virtual output VDO4 close delay time	0.00~600.00s	0.01s	0.00s	○
F20.19	Virtual output VDO5 close delay time	0.00~600.00s	0.01s	0.00s	○
F20.20	Virtual input VDI enable control	00~FF	1	00	○
F20.21	Virtual input VDI status digital setup	00~FF	1	00	○
F20.22	Virtual input:output connection	00~FF Bit0:VDI1 and VDO1 connection 0:positive logic 1:negative logic Bit1:VDI2 and VDO2 connection 0:positive logic 1:negative logic Bit3:VDI3 and VDO3 connection 0:positive logic 1:negative logic Bit4:VDI4 and VDO4 connection 0:positive logic 1:negative logic Bit4:VDI5 and VDO5 connection 0:positive logic 1:negative logic	1	00	○

F21—Reserved Parameter Group 3

Function code	Name	Set range	Min. unit	Factory default	Modification
F21.00~ F21.21	Reserved				

F22—Reserved Parameter Group 4

Function code	Name	Set range	Min. unit	Factory default	Modification
F22.00~ F22.17	Reserved				

F23—Reserved Parameter Group 5

Function code	Name	Set range	Min. unit	Factory default	Modification
F23.00~ F23.17	Reserved				

F24—Reserved Parameter Group 6

Function code	Name	Set range	Min. unit	Factory default	Modification
F24.00~F24.13	Reserved				

F25—User Definition Display Parameter Group

Function code	Name	Set range	Min. unit	Factory default	Modification
F25.00	User function code 1	F00.00~F25.xx	0.01	25.00	○
F25.01	User function code 2	F00.00~F25.xx	0.01	25.00	○
F25.02	User function code 3	F00.00~F25.xx	0.01	25.00	○
F25.03	User function code 4	F00.00~F25.xx	0.01	25.00	○
F25.04	User function code 5	F00.00~F25.xx	0.01	25.00	○
F25.05	User function code 6	F00.00~F25.xx	0.01	25.00	○
F25.06	User function code 7	F00.00~F25.xx	0.01	25.00	○
F25.07	User function code 8	F00.00~F25.xx	0.01	25.00	○
F25.08	User function code 9	F00.00~F25.xx	0.01	25.00	○
F25.09	User function code 10	F00.00~F25.xx	0.01	25.00	○
F25.10	User function code 11	F00.00~F25.xx	0.01	25.00	○
F25.11	User function code 12	F00.00~F25.xx	0.01	25.00	○
F25.12	User function code 13	F00.00~F25.xx	0.01	25.00	○
F25.13	User function code 14	F00.00~F25.xx	0.01	25.00	○
F25.14	User function code 15	F00.00~F25.xx	0.01	25.00	○
F25.15	User function code 16	F00.00~F25.xx	0.01	25.00	○
F25.16	User function code 17	F00.00~F25.xx	0.01	25.00	○
F25.17	User function code 18	F00.00~F25.xx	0.01	25.00	○
F25.18	User function code 19	F00.00~F25.xx	0.01	25.00	○
F25.19	User function code 20	F00.00~F25.xx	0.01	25.00	○
F25.20	User function code 21	F00.00~F25.xx	0.01	25.00	○
F25.21	User function code 22	F00.00~F25.xx	0.01	25.00	○
F25.22	User function code 23	F00.00~F25.xx	0.01	25.00	○
F25.23	User function code 24	F00.00~F25.xx	0.01	25.00	○
F25.24	User function code 25	F00.00~F25.xx	0.01	25.00	○
F25.25	User function code 26	F00.00~F25.xx	0.01	25.00	○
F25.26	User function code 27	F00.00~F25.xx	0.01	25.00	○
F25.27	User function code 28	F00.00~F25.xx	0.01	25.00	○
F25.28	User function code 29	F00.00~F25.xx	0.01	25.00	○
F25.29	User function code 30	F00.00~F25.xx	0.01	25.00	○

F26—Fault Record Function Parameter Group

Function code	Name	Set range	Min. unit	Factory default	Modification
F26.00	The last fault record	0:no fault 1:overcurrent at acceleration 2:overcurrent at deceleration 3:overcurrent at constant speed 4:overvoltage at acceleration 5:overvoltage at deceleration 6:overvoltage at constant speed 7:overvoltage at motor halt	1	0	*

		8:undervoltage at run 9:drive overload protection 10:motor overload protection 11:motor underload protection 12:input phase loss 13:output phase loss 14:inverter module protection 15:short circuit to earth at run 16:short circuit to earth when power on 17:drive overheat 18:external device fault 19:current detect circuit fault 20:external interference 21:internal interference—main clock etc 22:PID provide lost 23:PID feedback lost 24:PID error value abnormal 25:terminal protection activate 26:communication fault 27~29:reserve 30:EEROM read-write error 31:temperature detection disconnection 32:auto-tunning fault 33:contactor abnormal 34:factory fault 1 35:factory fault 2 36:capacitor overheat(few mode with overheat protection) 37~50: Reserved			
F26.01	The last two fault records	Same as above	1	0	*
F26.02	The last three fault records	Same as above	1	0	*
F26.03	The last four fault records	Same as above	1	0	*
F26.04	Setup frequency at the last one fault	0.00Hz~upper limit frequency	0.01Hz	0	*
F26.05	Output frequency at the last one fault	0.00Hz~upper limit frequency	0.01Hz	0	*
F26.06	Output current at the last one fault	0.0~6553.5A	0.1A	0.0A	*
F26.07	DC busbar voltage at the last one fault	0.0~6553.5V	0.1V	0.0V	*
F26.08	Module temperature at the last one fault	0~125℃	1℃	0℃	*
F26.09	Input terminal status at the last one fault	0000~FFFF	1	0000	*
F26.10	Accumulated run time at the last one fault	0~65535h	1h	0	*
F26.11	Setup frequency at the last two fault	0.00Hz~upper limit frequency	0.01Hz	0.00Hz	*
F26.12	Output frequency at the last two fault	0.00Hz~upper limit frequency	0.01Hz	0.00Hz	*
F26.13	Output current at the last two fault	0.0~6553.5A	0.1A	0.0A	*
F26.14	DC busbar voltage at the last two fault	0.0~6553.5V	0.1V	0.0V	*

F26.15	Module temperature at the last two fault	0~125℃	1℃	0℃	*
F26.16	Input terminal status at the last two fault	0000~FFFF	1	0000	*
F26.17	Accumulated run time at the last two fault	0~65535h	1h	0h	*

F27—Password and Manufacturer Function Parameter Group

Function code	Name	Set range	Min. unit	Factory default	Modification
F27.00	User password	00000~65535	1	00000	○
F27.01	Manufacturer password	00000~65535	1	00000	○

C—Monitor Function Parameter Group

Function code	Name	Set range	Min. unit	Factory default	Modification
C-00	Display the parameter of F00.01, F00.07 definition				
C-01	Display the parameter of F00.02, F00.08 definition				
C-02	Display the parameter of F00.03, F00.09 definition				
C-03	Display the parameter of F00.04, F00.10 definition				
C-04	Display the parameter of F00.05, F00.11 definition				
C-05	Display the parameter of F00.06, F00.12 definition				

(1) corresponding relationship of input terminal status as below:

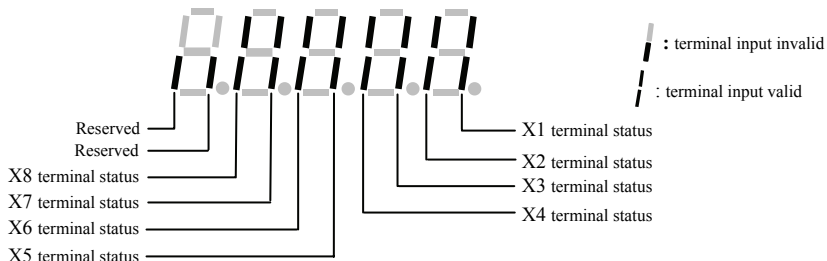

(2) Corresponding relationship of standard output terminal status as below:

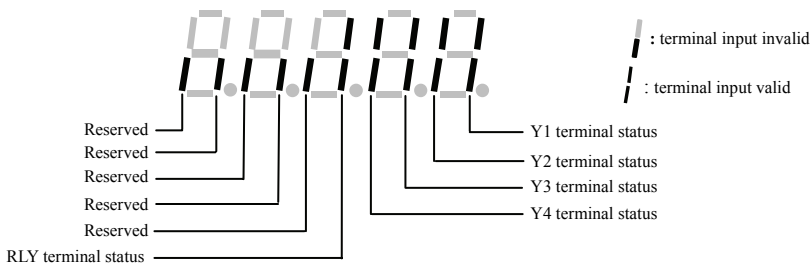

(3) Corresponding relationship of communication virtual input terminal status as below:

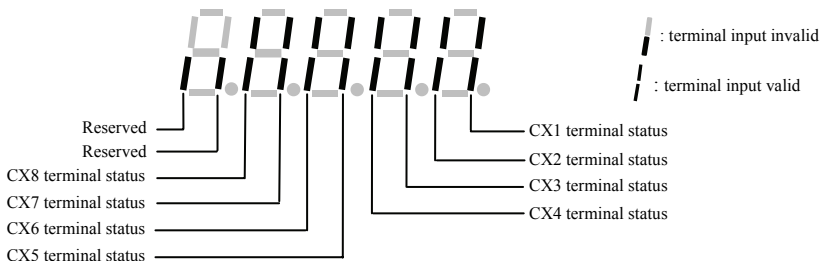

(4) Drive status:

- BIT0:1=busbar voltage setup
- BIT1:1=common run command valid
- BIT2:1=jog run command valid
- BIT3:1=drive run period
- BIT4:1=current run direction to reverse
- BIT5:1=run command direction to reverse
- BIT6:1=deceleration brake period
- BIT7:1=motor acceleration period
- BIT8:1=motor deceleration period
- BIT9:1=drive alarm
- BIT10:1=drive fault
- BIT11:1=current limited period
- BIT12:1=fault self-recovery period
- BIT13:1=self-adjusting period
- BIT14:1=free halt status
- BIT15:1=speed tracking start

7 Detailed Function Specification

The parameter function code of this chapter listed content as below:

Code No.	Description	Setup Range/Explanation	Factory Default
----------	-------------	-------------------------	-----------------

7.1 System Parameter Group:F00

F00.00	Parameter group display control	Range:0~3	0
--------	---------------------------------	-----------	---

0:Basic list mode.Display only F00,F01,F02,F03 basic control parameter group and F26 fault record parameter group.

1:Middle list mode.Display all parameter except for extension: virtual and reserve parameter group.

2:Senior list mode. All parameter display.

3:User list mode.Display parameter defined by user: and monitor parameter: F00.00 display all the time.



Note

F00.00 display all the time.Under middle list mode:irrelevant parameter can be covered according to different control mode.

F00.01	C-00 display parameter selection when operation	Range:0~65	3
F00.02	C-01 display parameter selection when operation	Range:0~65	2
F00.03	C-02 display parameter selection when operation	Range:0~65	4
F00.04	C-03 display parameter selection when operation	Range:0~65	5
F00.05	C-04 display parameter selection when operation	Range:0~65	6
F00.06	C-05 display parameter selection when operation	Range:0~65	9

The above parameter display when inverter run by C-00~C-05 parameter groups, pressing $\langle \gg \rangle$ to switch between these parameters. Pressing $\langle \text{ENTER DATA} \rangle$ return to C-00 parameter monitor. For example:pressing $\langle \gg \rangle$ parameter switch from C-00 to C-01: continuous pressing the same button:parameter switch from C-01 to C-02: then pressing $\langle \text{ENTER DATA} \rangle$ return to C-00 parameter monitor.

- 0:main setup frequency (0.01Hz)**
- 1:auxiliary setup frequency (0.01Hz)**
- 2:setup frequency (0.01Hz)**
- 3:output frequency (0.01Hz)**
- 4:output current (0.1A)**
- 5:output voltage (1V)**
- 6:DC busbar voltage (0.1V)**
- 7:motor speed (1 circle/min)**
- 8:motor line velocity (1 circle/min)**
- 9:inverter temperature (1℃)**
- 10:run time already this time (0.1min)**
- 11:current accumulate run time (1h)**
- 12:current accumulate power-on time (1h)**
- 13:inverter status**
- 14:input terminal status**
- 15:output terminal status**
- 16:extension output terminal status**
- 17:extension input terminal status**
- 18:communication virtual input terminal status**
- 19:internal virtual input node status**
- 20:analog input AI1 (after checkout) (0.01V / 0.01mA)**
- 21:analog input AI2 (after checkout) (0.01V / 0.01mA)**
- 22:extension analog input EAI1 (after checkout) (0.01V / 0.01mA)**
- 23:extension analog input EAI2 (after checkout) (0.01V / 0.01mA)**
- 24:analog AO1 output (0.01V / 0.01mA)**
- 25:analog AO2 output (0.01V / 0.01mA)**
- 26:extension analog EAO1 output (0.01V / 0.01mA)**
- 27:extension analog EAO2 output (0.01V / 0.01mA)**
- 28:external pulse input frequency (1Hz)**
- 29:operation panel potentiometer voltage (0.01V)**
- 30:process PID provide (0.01V)**
- 31:process PID feedback (0.01V)**
- 32:process PID deviation (0.01V)**
- 33:process PID output (0.01Hz)**
- 34:simple PLC current segment No.**
- 35:external multi-speed current segment No.**
- 36:constant pressure water supply provide pressure (0.001Mpa)**
- 37:constant pressure water supply feedback pressure (0.001Mpa)**

- 38:constant pressure water supply relay status**
39:current length (1M)
40:accumulate length (1M)
41:current internal count value
42:current internal time value
43:run command setup channel (0:keyboard 1:terminal 2:communication)
44:main frequency provide channel
45:auxiliary frequency provide channel
46:rated current (0.1A)
47:rated voltage (1V)
48:rated power (0.1KW)
49~65: Reserved

F00.07	C-00 display parameter selection when stop	Range:0~65	2
F00.08	C-01 display parameter selection when stop	Range:0~65	6
F00.09	C-02 display parameter selection when stop	Range:0~65	48
F00.10	C-03 display parameter selection when stop	Range:0~65	14
F00.11	C-04 display parameter selection when stop	Range:0~65	20
F00.12	C-05 display parameter selection when stop	Range:0~65	9

The above parameter display when inverter stop by C-00~C-05 parameter group, pressing $\langle \gg \rangle$ to switch between these parameters.

Pressing $\langle \text{ENTER DATA} \rangle$ return to C-00 parameter monitor.

For example:pressing $\langle \gg \rangle$ parameter switch from C-00 to C-01, continuous pressing the same button:parameter switch from C-01 to C-02: then pressing $\langle \text{ENTER DATA} \rangle$ return to C-00 parameter monitor.Monitor content various as different monitor parameter: refer to parameter F00.01.



Note

EN500 monitor parameter group C-00~C-05 have run and stop modes.For example C-00 display different physical value under run and stop two modes.

F00.13	Power-on fault monitor parameter selection	Range:0~5	0
--------	--	-----------	---

When the parameter power on first time: C monitor parameter group display

under drive run or stop status, For example F00.13=1, power on or stop to monitor, display parameter setup by C-01; when F00.02=3, F00.08=6, power on, inverter stops, busbar voltage display; inverter runs, output frequency display.

F00.14	Parameter operation control	Range: LED units digit:0~2 LED tens digit:0~5 LED hundreds digit:0~4	000
---------------	------------------------------------	---	------------

LED units digit:

0:All parameters are allowed to modification.

1: Except this parameter, the others parameter are not allowed to modification.

2:Except F01.01, F01.04 and this parameter, the others parameter are not allowed to modification.

LED tens digit:

0:No action.

1:All parameters return to default. (not include fault record parameter group (F26 group) parameter) .

2:Except for motor parameter: all parameters return to default. (not include F15 and F26 group parameter) .

3:Extension parameter return to default. (only F21~F24 group parameter return to default) .

4:Virtual parameter return to default. (only F20 group parameter return to default) .



5:Fault record return to default. (only fault record parameter group (F26 group) parameter return to default) .



LED hundreds digit:

0: All locked.

1: Except  button: the others locked

2: Except  ,  button: the others locked.

3: Except ,  button: the others locked.



4: Except ,  button: the others locked.



Note

1.In factory status, the unit of this function code parameter is 0, and it is default and allowed to change all the other function code parameters: when user finish: and want to change the function code setup: this function code parameter should set up 0 first. When all changes finish and need to do parameter protect: this function code setup into the IP grade you need.

2.the decade recover to 0 automatically after record remove or factory default operation.

3.When the third of parameter F00.14 finish setup:  button pressing lasting for 2 seconds to lock keyboard and relevant keyboard key: when need to unlock the keyboard: press the  button for 2 seconds.

F00.15	Button function selection	Range: LED units digit :0,1 LED tens digit :0~9 LED hundreds digit :0,1 LED thousands digit :0,1	0001
---------------	----------------------------------	---	-------------

LED units digit: panel  button selection

0:Reversal command action button

1:Jog action button

LED tens digit: multi-function  button function selection

0:Invalid.

1:Jog run.multi-function button as jog run button:run direction decided by unit bit of F01.16's LED.

2:For/rev switching. press this button to change the run direction when run: then press the same button chang to another direction.

3:Free stop.setup free stop function and stop mode F02.11 the same function with 1 Jog run.

4:Switching to run command provide mode as the setup order of F00.16.
5~9: Reserved

LED hundredth:terminal run command control

0:Keyboard  button invalid

1:Keyboard  button valid

LED thousandth:communication run command control

0:Keyboard  button invalid

1:Keyboard  button valid

F00.16	Multi-function key run command channel switching order selection	Range:0~3	0
---------------	---	------------------	----------

0:Keyboard control→terminal control→communication control

1:Keyboard control←→terminal control

2:Keyboard control←→communication control

3:Terminal control←→communication control

These parameters cooperate with multi-function key to run command channel switching function: with special switch to command channel switching order.



Note

Command channel priority terminal switch to (terminal function code 49,50,51) →terminal run command channel selection (terminal function code 52,53) →multi-function key switch→F01.15, when switching to terminal control, be sure the terminal command invalid. Terminal switch to and terminal run command channel selection refer to F08 group parameter about the detailed description of terminal function.

F00.17	Motor speed display coefficient	Range:0.1~999.9%	100.0%
---------------	--	-------------------------	---------------

This function code is used to check speed scale display error, there is no effect to motor actual speed.

F00.18	Line velocity display coefficient	Range:0.1~999.9%	1.0%
---------------	--	-------------------------	-------------

This function is used to check line velocity scale display error:there is no effect to actual line velocity.

F00.19	Reserved		
---------------	-----------------	--	--

F00.20	Analog input terminal configuration	Range: LED units digit :0,1 LED tens digit :0,1 LED hundreds digit :0~2 LED thousands digit :0~2	0000
---------------	--	---	-------------

This parameter can configurate analog input AI1, AI2, EAI1,EAI2 to be current input type or voltage input type.

LED units digit: AI1 configuration

0:0~10V input

1:4~20mA input

LED tens digit: AI2 configuration

0:-10~10V input

1:4~20mA input

LED hundreds digit: EAI1 configuration

0:0~10V input

1:-10~10V input

2:4~20mA input

LED thousands digit: EAI2 configuration

0:0~10V input

1:-10~10V input

2:4~20mA input



Note

Dial switching (SW1,SW2) under the left corner of CPU to the corresponding position: when AI1,AI2 configuration.

F00.21	Analog output terminal configuration	Range: LED units digit :0,1 LED tens digit :0,1 LED hundreds digit :0,1 LED thousands digit :0,1	0000
--------	--------------------------------------	---	------

This parameter can configure AO1,AO2,EAO1,EAO2 analog signal output to be voltage type or current type.

LED units digit: AO1 configuration

0:0~10V output

1:4~20mA output

LED tens digit: AO2 configuration

0:0~10V output

1:4~20mA output

LED hundreds digit: EAO1 configuration

0:0~10V output

1:4~20mA output

LED thousands digit: EAO2 configuration

0:0~10V output

1:4~20mA output



Note

Dial switching (SW3,SW4) under left corner of CPU to the corresponding position: when AO1,AO2 configuration.

F00.22	Y output terminal configuration	Range: LED units digit :Reserved LED tens digit :Reserved LED hundreds digit : Reserved LED thousands digit :0,1	0000
---------------	--	---	-------------

LED units digit~LED hundreds digit: Reserved

LED thousands digit: Y4 output configuration

0:Open collector output

1:DO output

The LED thousands digit decide the Y4 output terminal type, when 0 means open collector output,when 1 means high speed pulse DO output.

F00.23	G/P type setup	Range:0,1	0
---------------	-----------------------	------------------	----------

0:G type. Adapt to constant torque load type.

1:P type. Adapt to fan & pump load type.

EN500 integrates GP type design in full power range. F15 group motor relative parameter will change automatically according to the G or P type.

F00.24	Motor control mode	Range:0~2	0
---------------	---------------------------	------------------	----------

0:V/F control

Choose to V/F control mode to achieve one drive one more motors,V/F control mode can be used in few synchronous motor case.

1: Speedless Vector Control

Speedless sensor vector control run mode, mainly used to velocity control,torque control in the application site which require high control performance.Setting up motor parameter group F15 according to the motor nameplate details,and doing the self-learning to motor parameter to get better control performance.One VFD can only drive one motor in vector control mode, and VFD power need match up with motor,normally one class less or more of the VFD power than motor is allowed.

2: Reserved

F00.25	Reserved		
F00.26	Reserved		
F00.27	Reserved		

7.2 Basic Run Function Parameter Group:F01

F01.00	Main frequency input channel selection	Range:0~14	0
---------------	---	-------------------	----------

Total 15 types input channel for selection to chose inverter input channel of the main provide frequency,among 11~14 are reserve channel,currently there is no corresponding function.

0:Operation keyboard digital setup. When main frequency setup initial value to F01.01: modify F01.01 parameter to change main setting frequency with operation keyboard: or with $\textcircled{\wedge}$, $\textcircled{\vee}$ button to modify the value of F01.01.

1:A11 analog setup. main frequency setup confirmed by A11 analog voltage/ current, input range: 0~10V(A11 jumper wire selection V side)or 4~20mA(A11 jumper wire selection A side).

2:A12 analog setup. main frequency setup confirmed by AI2 analog voltage/current, input range: -10~10V(AI2 jumper wire selection V side)or 4~20mA(AI2 jumper wire selection A side).

3:Terminal UP/DOWN adjusting setup. When main frequency initial value is parameter F01.01 , through terminal UP/DOWN function to adjust the main setting frequency.Terminal function setup into 16 (frequency increase progressively (UP)) or 17 (frequency decrease progressively control (DOWN)).

4:Communication provide. main frequency provide by selection communication mode.

5:EAI1 analog setup. when extension analog input EAI1 is valid, main frequency confirmed by EAI1 analog voltage/current , input range:-10 ~ 10V(EAI1 jumper wire selection V side)or 4~ 20mA(EAI1 jumper wire selection A side).Relevant extension card selection needed to use this setup function.

6:EAI2 analog setup. when extension analog input EAI2 valid, main frequency setup by EAI2 analog voltage / current, input range:-10~10V(EAI2 jumper wire selection V side) or 4~ 20mA(EAI2 jumper wire selection A side). Relevant extension card selection needed to use this setup function.

7:High speed pulse setup. main frequency setup by frequency signal of terminal pulse(only X8 input), input pulse specification:voltage range 15~30V; frequency range 0.00~50.00KHz.

8:Terminal pulse setup. main frequency setup by pulse width signal of terminal pulse(only X8 input), input pulse specification:voltage range 15~30V; pulse width range 0.1~999.9ms.

9:Terminal encoder setup.main frequency setup by terminal encoder pulse(only combination input by X1 and X2) and frequency velocity set by

parameter F08.30.

10:Keyboard analog potentiometer setup.main frequency setup by operation keyboard analog potentiometer (keyboard with analog potentiometer for optional accessories).

11~14: Reserved.



Note

Analog provide is positive and negative polarity control, its prior to command direction control: when main frequency provide is AI2,EAI1,EAI2 : and setup provide to be -10~10V, run direction confirmed by analog provide signal polarity completely, when PID run is valid, run direction confirmed by PID error polarity and parameter F11.21 completely.



Excerpt terminal encoder provide (F01.00=9) , main and auxiliary provide channel cannot be set into the same frequency source: if they are the same: then panel would be light (ALM) and display A-51.

F01.01	Main frequency digital setup	Range:0.00Hz~upper limit frequency	50.00Hz
---------------	-------------------------------------	---	----------------

When F01.00=0, 3 or 4, F01.01 is the initial value of main frequency.

F01.02	Main frequency digital control	Range:00~11	11
---------------	---------------------------------------	--------------------	-----------

LED units digit: power down reserve setup

0:Main frequency power down reserve. When main frequency channel provide is valid, power down in run status, current main frequency of run frequency is recorded in parameter F01.01.

1:Main frequency power down no reserve.

LED tens digit: halt reserve setup

0:Halt main frequency hold. when main frequency channel provide is valid, current run frequency only recorded after halt.

1:Halt main frequency recovery F01.01. main setting frequency recorded in software is recovery to value of parameter F01.01 after halt.



Note

Only when parameter F01.00=0,3,4 valid.

F01.03	Auxiliary frequency input channel select	Range:0~20	1
--------	--	------------	---

VFD auxiliary provide frequency input channel has 21 input channels for selection, for them 11~20 are Reserved channels, and currently there is no relevant functions:

0:Keyboard operation digital setup. When auxiliary frequency setup initial value is parameter F01.04, modify parameter F01.04 to change auxiliary setting frequency: or with $\text{\textcircled{\small \wedge}}$, $\text{\textcircled{\small \vee}}$ button modify the value of parameter F01.04.

1:AI1 analog setup. Auxiliary frequency setup confirmed by AI1 analog voltage /current, input range: 0~10V (AI1 jumper wire selection V side) or 4~20mA (AI1 jumper wire A side) .

2:AI2 analog setup. Auxiliary frequency setup confirmed by AI2 analog voltage/current, input range: -10~10V(AI2 jumper wire selection V side) or 4~20mA (AI2 jumper wire selection A side) .

3:Terminal UP/DOWN adjusting setup. Auxiliary frequency initial value is parameter F01.04, through terminal UP/DOWN function to adjust auxiliary setting frequency.

4:Communication provide. auxiliary frequency provide by selection communication mode.

5:EAI1 analog setup. When extension analog input EAI1 is valid, auxiliary frequency setup confirmed by EAI1 analog voltage/current, input range: -10~10V (EAI1 jumper wire selection V side) or 4~20mA (EAI1 jumper wire selection A side) .

6:EAI2 analog setup. When extension analog input EAI2 is valid, auxiliary frequency setup confirmed by EAI2 analog voltage/current, input range: -10~10V (EAI2 jumper wire selection V side) or 4~20mA (EAI2 jumper wire selection A side) .

7:High speed pulse setup. Auxiliary frequency setup by frequency signal of terminal pulse (only X8 input) , input pulse specification:voltage range 5~30V; frequency range 0.00~50.00KHz.

8:Terminal pulse width setup. Auxiliary frequency setup by pulse width signal of terminal pulse (only X8 input) , input pulse specification:voltage range 15~30V; pulse width range 0.1~999.9ms.

9:Terminal encoder provide. Auxiliary frequency setup by terminal encoder pulse (only X3 or X4 input) ,0.01Hz is a fixed adjusting precision.

10:Keyboard analog potentiometer setup. Auxiliary frequency setup by operation keyboard analog potentiometer (keyboard with analog potentiometer for

optional accessories) .

11~20: Reserved.



Analog provide is positive and negative polarity control, its prior to command direction control: when auxiliary frequency provide is AI2,EAI1,EAI2 , and setup provide is to be -10~10V, run direction confirmed by analog provide signal polarity completely.



Except terminal encoder provide (F01.03=9) , main and auxiliary provide channel cannot setup to the same frequency source, when they are the same, then panel light (ALM) , and A-51 display.

F01.04	Auxiliary frequency digital setup	Range:0.00Hz ~ upper limit frequency	0.00Hz
---------------	--	---	---------------

When F01.03=0, 3 or 4, F01.04 is the initial frequency value of auxiliary frequency.

F01.05	Auxiliary frequency digital control	Range:00~11	11
---------------	--	--------------------	-----------

LED units digit: power down reserve setup

0:Auxiliary frequency power down reserve. when auxiliary frequency channel provide is valid and power down at run mode, the current auxiliary setting frequency reserve in parameter F01.04.

1:Auxiliary frequency power down no reserve.

LED tens digit: halt reserve setup

0:Halt auxiliary frequency hold. when auxiliary frequency channel provide is valid, recording current run frequency only after halt.

1:Halt auxiliary frequency recovery parameter F01.04 .auxiliary setting frequency in software recording is recovered the value of parameter F01.04 after halt.



Only when F01.03=0,3,4 is valid.

F01.06	Main and auxiliary provide calculating setup	Range:0~7	0
---------------	---	------------------	----------

This parameter is to select frequency provide channel, and through the complex of main frequency source and auxiliary frequency source to achieve frequency provide.

0:Main frequency.complex frequency of current is main frequency.

1: Auxiliary frequency.complex frequency of current is auxiliary frequency.

2: Plus (polarity oppose of complex and main frequency, complex frequency is zero) .

3:Minus (polarity oppose of complex and auxiliary frequency, complex frequency is zero) .

4:Multiplication (polarity opposed of main and auxiliary frequency: complex frequency is zero) .

5:Max (the max frequency of main and auxiliary absolute value) .

6:Min (the min frequency of main and auxiliary absolute value) .

7:Selection no-zero value (auxiliary is not negative, main frequency prior; auxiliary is negative, complex frequency is zero) .



Note

1.The initial polarity of main and auxiliary frequency cannot change after main and auxiliary operation.

2.When main and auxiliary frequency channel are complex value, and both setup into power down reserve: parameter F01.01 and F01.04 reserve separately the changed part of main frequency and auxiliary frequency in the complex frequency when power down.

F01.07	Auxiliary frequency provide coefficient	Range:0.00~10.00	1.00
---------------	--	-------------------------	-------------

Parameter F01.07 can adjust auxiliary provide frequency gain.

F01.08	Coefficient after complex of main and auxiliary frequency	Range:0.00~10.00	1.00
---------------	--	-------------------------	-------------

This parameter is to setup frequency flexibly and calculate the gain of complex setting frequency by main and auxiliary frequency.

F01.09	Auxiliary frequency range selection	Range:0,1	0
---------------	--	------------------	----------

0:Relative high limit frequency. Auxiliary frequency setup range:0.00Hz~high limit frequency×F01.10.

1:Relative main frequency.Auxiliary frequency setup range:0.00Hz~main frequency×F01.10.

F01.10	Auxiliary frequency source scope	Range:0.00~1.00	1.00
---------------	---	------------------------	-------------

This parameter cooperate with F01.09 define the scope of auxiliary provide frequency.Auxiliary provide frequency high limit value is restrained by the

frequency selected by parameter F01.09 through parameter F01.10 gain calculation.

F01.11	Upper limit frequency	Range: low limit frequency ~ 650.00Hz	50.00Hz
---------------	------------------------------	--	----------------

This parameter's max setting frequency of all run mode should be modification carefully according to the motor nameplate details.

F01.12	Low limit frequency	Range:0.00Hz ~ upper limit frequency	0.00Hz
F01.13	Low limit frequency run mode	Range:0~3	0
F01.14	Sleep run hysteresis frequency	Range:0.01Hz ~ Upper limit frequency	0.01Hz

0:As low limit frequency run.

1:As setting frequency run.

2:As zero frequency run.

3:Sleep: PWM clocked at sleep mode.



When actual setting frequency lower than low limit frequency, low limit frequency run mode selection 0, then drive run at low limit frequency; low limit frequency run mode selection 1, drive continuously run according to setting frequency; low limit frequency run mode selection 2, drive continuously low output frequency and run at zero frequency; low limit frequency run mode selection 3, immediately clock the output and display frequency decline slowly to zero, when provide value over low limit frequency, drive restart to accelerate run from 0Hz to provide value after through F01.14 stagnant loop.



Note

When F01.13=3: this parameter can finish sleep function to achieve energy saving run and avoid drive to start frequently at threshold value through width of return difference.

F01.15	Run command channel selection	Range:0~2	0
---------------	--------------------------------------	------------------	----------

0:Operation keyboard run control. Start and stop with , ,  on operation keyboard.

1:Terminal run command control. Terminal X1 is forward (FWD), X2 is reverse(REV)during the function code X1~X8 setup.Other terminal can also be regarded as for/rev input terminal.

2:Communication run command control. Start and stop with communication mode.



1. Drive can change run command channel through switch of multi-function key, terminal command channel in halt and run, carefully modify command channel after confirm in site the permission to run command channel modification. After the command channel modification, keyboard  button setup valid or not by parameter F00.15 .
2. After run command channel modification, frequency channel can be defined by parameter F18.00, F18.01, F18.02 .or defined by parameter F01.00, F01.03, F01.06 and multi-function terminal.

F01.16	Run direction setup	Range: LED units digit :0,1 LED tens digit :0~2	00
--------	---------------------	--	----

LED units digit: Keyboard command for/rev setup (only valid to keyboard inching command)

0:Forward.

1:Reverse.

LED tens digit: for/rev forbid (suitable for all command channel, not include inching function)

0:For/rev available.

1:Reverse not available (imposing on reverse, stop as the halt mode).

2:Forward not available (imposing on forward, stop as the halt mode) .

F01.17	Acceleration time 1	Range:1~60000	Base on motor type
F01.18	Deceleration time 1	Range:1~60000	Base on motor type

Acceleration time is interval accelerate from zero frequency to high limit frequency, deceleration time is the interval decelerate from high limit frequency to zero frequency. The unit defined by F01.19. Example:F01.17=100, F01.19=1, acceleration time 1 is 10.0 seconds.



Note

1. EN500 series drive defines 15 acceleration and deceleration time, only acceleration and deceleration time 1 defined here, acceleration and deceleration 2~15 defined in parameter F04.16~F04.43.
2. Acceleration and deceleration 1~15 select time unit through parameter F1.19, factory default unit is 0.1 second.

F01.19	Acc/dece time unit	Range:0~2	1
--------	--------------------	-----------	---

This function can define acceleration and deceleration time unit.

0:0.01s

1:0.1s

2:1s



Note

- 1, The function is valid to all acceleration and deceleration except for inching run.
- 2, Advise to select 0.1s as the time unit.

F01.20	Acc/dece mode selection	Range:0,1	0
---------------	--------------------------------	------------------	----------

0:Line acc/dece mode.output frequency raise or decline as the constant slope, as fig.7-1.

1:S curve acc/dece mode.output frequency raise or decline as the S curve: as fig.7-2.

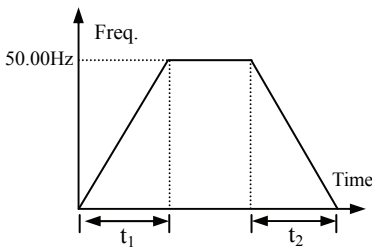

Fig. 7-1 Line acc/dece

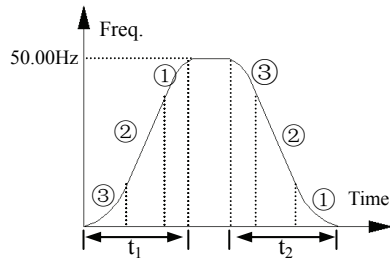

Fig. 7-2 S curve acc/dece

F01.21	S curve acceleration initiation segment time	Range:10.0%~50.0%	20.0%
F01.22	S curve acceleration up segment time	Range:10.0%~70.0%	60.0%
F01.23	S curve deceleration initiation segment time	Range:10.0%~50.0%	20.0%
F01.24	S curve deceleration up segment time	Range:10.0%~70.0%	60.0%

F01.21~F01.24 select S curve acceleration and deceleration mode (F01.20=1) valid only under acceleration and deceleration, and F01.21+F01.22≤90% , F01.23+F01.24≤90%.

S curve start interval time as fig.7-2③, output frequency changed slope increase slowly from zero.

S curve up interval time as fig.7-2②, output frequency changed slope is constant.

S curve end interval time as fig.7-2①, output frequency changed slope decrease

slowly to zero.



Note

S curve acc/dece mode is suitable for the start and stop of elevator,conveyor belt,transport and transfer load so on.

F01.25	Keyboard jog run frequency	Range:0.00Hz ~ upper limit frequency	5.00Hz
F01.26	Terminal jog run frequency	Range:0.00Hz ~ upper limit frequency	5.00Hz
F01.27	Jog interval time	Range:0.0~100.0s	0.0s
F01.28	Jog acceleration time	Range:0.0~6000.0s	20.0s
F01.29	Jog deceleration time	Range:0.0~6000.0s	20.0s

F01.25,F1.26 define keyboard jog and terminal jog run frequency,when jog run, accelerate as the zero frequency,and not effect by the start mode defined by parameter F02.00. when jog command revocation,stop as setting halt mode,when input another command during the deceleration,accelerate or decelerate according to the current frequency.

F1.27 defies valid command interval time at continuously jog. When jog command invalid,the time restart jog command is short than jog interval time,jog command ignore here.

F1.28,F1.29 define jog run acceleration and deceleration time, fixed unit is 1s.

7.3 Start, stop, forward/reverse, brake function parameter group: F02

F02.00	Start running mode	Range:0~2	0
---------------	---------------------------	------------------	----------

0: Start from starting frequency. After receiving start command by setting F02.01 delay time, the inverter starts after setting F02.02 starting frequency and F02.03 starting frequency duration.

1: First brake, and then start from starting frequency. First brake the current from DC and then from time (F02.04, F02.05), and then start after setting starting frequency and starting frequency duration set by F02.03.

2: Start by revolving speed tracking. Currently this starting mode can be realized by V/F control mode.



Note

1. **Start-up mode 0:** It is suggested to use Start-up mode 0 for general purpose applications and for general drive synchronous motor.
2. **Start-up mode 1:** Suitable for small inertia load, for example, forward and reverse occurs when the motor is not driven.
3. **Start-up mode 2:** Suitable for the starting of large inertia load before stopping stably. Generally this mode is used when restarting after power failure, fault self-recovery and other functions. The following points need to be noticed when this Start-up mode is used:
 - 3.1 When the inverter stops freely, restart the inverter after a few seconds. If over-current fault occurs when starting, please extend the F02.08 time.
 - 3.2 Do not modify the set frequency when the inverter starts in slow down process.

F02.01	Starting delay time	Range:0.0~60.0s	0.0s
---------------	----------------------------	------------------------	-------------

Starting delay time refers to the waiting time before the inverter is started after receiving running command.

F02.02	Starting frequency	Range:0.0~10.00Hz	0.00Hz
F02.03	Starting frequency duration	Range:0.0~60.0s	0.0s

Starting frequency refers to the initial frequency when the inverter is started, as shown in Fig. 7-3 fs; Starting frequency holding time refers to consecutive running time during which the inverter runs at the starting frequency, as shown in Fig. 7-3 t₁.

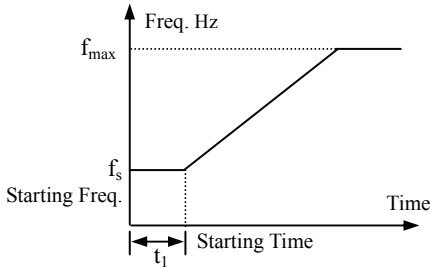

Fig. 7-3 Starting frequency and starting time



Note

Starting frequency is not limited by lower limit frequency.

F02.04	DC braking current when starting	Range: 0.0 ~ 100.0% (G type inverter rated current)	30.0%
F02.05	DC braking time when starting	Range:0.0~30.0s	0.0s

When F02.00=1, F02.04, F02.05 valid, and stop mode is deceleration stop, as shown in Fig. 7-4.

The setting of starting DC braking current is with respect to the percentage of inverter rated output current. When starting DC braking time is 0.0 second, no DC braking process.

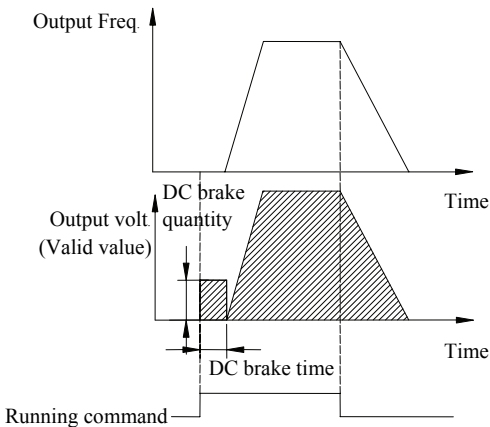

Fig. 7-4 Starting mode 1 description

F02.06	Speed track starting frequency selection	Range:0~2	2
---------------	---	------------------	----------

0: Current setting frequency.

1: Running frequency before power down.

2: Speed track auxiliary starting frequency.

Select frequency closed to the current running frequency of the motor so as to track the current running revolving speed of the motor. For example, when current running frequency is closed to current setting frequency, select 0 and start to search from current setting frequency.

F02.07	Speed track auxiliary starting frequency	Range:0.00Hz ~ upper limit frequency	10.00Hz
---------------	---	---	----------------

This parameter defines when 2 is selected in F02.06 parameter, the starting searching frequency when revolving track is started.

F02.08	Speed track starting waiting time	Range:0.00~10.00s	0.10s
---------------	--	--------------------------	--------------

When 2 is selected in F02.00, if the inverter checks that the running command is valid, the revolving speed is searched after the time defined by F2.08.

F02.09	Speed track current control coefficient	Range:1~20	2
---------------	--	-------------------	----------

This parameter does not need to be modified generally.

F02.10	Speed track searching speed time	Range:0.1~30.0s	10.0s
---------------	---	------------------------	--------------

This parameter can be modified to improve speed track time.



Note

F02.06~F02.10 parameter is valid only when inverter is started according speed checking mode in V/F mode.

F02.11	Stop mode	Range:0~2	0
---------------	------------------	------------------	----------

0: Deceleration stop. After receiving stop command, the inverter reduces output frequency gradually according to the set deceleration time, the inverter stops when frequency is 0.

1: Free stop. After receiving stop command, the inverter stops output immediately, and the load stops freely according to mechanical inertia.

2: Deceleration + DC braking stop. After receiving stop command, the inverter reduces output frequency gradually according to the set deceleration time. When reaching F02.14 starting frequency of stop braking, After F02.15 defines DC braking waiting time, the inverter starts DC braking, as shown in Fig. 7-5.

F02.12	Deceleration stop holding frequency	Range:0.00Hz~upper limit frequency	0.00Hz
F02.13	Deceleration stop holding time	Range:0.00~10.00s	0.00s

The parameters F02.12 and F02.13 define inverter’s deceleration stop holding function. When the frequency reaches set value of F02.12 in deceleration, it stops deceleration, and maintains the set time of F02.13, and enters deceleration state. This parameter is only valid for stop mode 0.

F02.14	Stop DC braking starting frequency	Range:0.00~15.00Hz	0.00Hz
F02.15	Stop DC braking waiting time	Range:0.00~30.00s	0.00s
F02.16	Stop DC braking current	Range:0.0~100.0% (G type inverter rated current)	0.0%
F02.17	Stop DC braking time	Range:0.0~30.0s	0.0s
F02.18	Stop auxiliary braking current	Range:0.0~100.0% (G type inverter rated current)	0.0%
F02.19	Stop auxiliary braking time	Range:0.0~100.0s	0.0s

F02.14 ~ F02.19 parameter defines the current and duration inputting to the motor in the stop DC braking state. If F02.17, F02.19 or F02.14 parameter is 0.0s, no DC braking process.

Auxiliary DC brake means when the inverter stops DC brake is finished give the second stage DC braking. Role in some special circumstances require rapid braking, and stop long time in the state of DC braking, but to prevent motor heat circumstances.

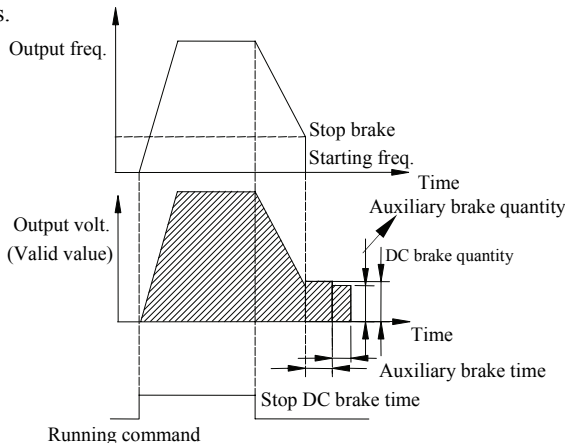

Fig. 7-5 Deceleration stop + DC braking

F02.20	Forward/reverse dead zone time	Range:0.0~3600.0s	0.1s
F02.21	Forward/reverse switching mode	Range:0,1	0

0: Over zero switchover

1: Over starting frequency switchover

Forward/reverse dead zone time refers to the process in which the inverter operates from forward to reverse or from reverse to forward. After output frequency reaches the defined frequency in switchover mode, entering in to the transition time, as shown in Fig. 7-6 t_1 , within transition time t_1 , output frequency is 0Hz.

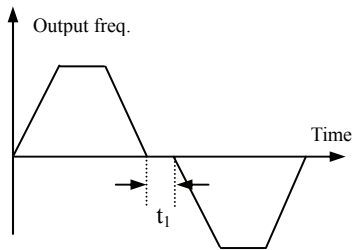

Fig. 7-6 Forward/reverse dead zone time

F02.22	Energy consumption braking selection	Range:0,1	Base on motor type
---------------	---	------------------	---------------------------

0: No energy consumption braking.

1: Energy consumption braking.



Note

Please set the function parameter correctly according to the actual use condition. Otherwise, control feature will be affected. Before starting this function, make sure the inverter has built-in brake unit and brake resistor.

F02.23	Energy consumption braking voltage	Range:115.0~145.0% (rated busbar voltage)	125.0%
F02.24	Energy consumption braking use rate	Range:0.0~100.0%	50.0%

Energy consumption braking function is only valid for built-in brake unit. F02.23 defines energy consumption braking busbar voltage threshold value, F02.24 parameter adjusts duty ratio brake unit. The higher the brake use rate is, the greater the brake unit duty ratio is, and the more apparent the brake effect is, but

when fluctuation of the brake process busbar voltage is more apparent, user needs to select proper parameter based on brake resistor and brake power.

F02.25	Reserved		
F02.26	Reserved		

7.4 V/F control parameter group: F03

F03.00	V/F curve setting	Range:0~4	0
---------------	--------------------------	------------------	----------

0: Constant torque curve.

1: Degression torque curve 1.

2: Degression torque curve 2.

3: Degression torque curve 3.

4: V/F curve setting (V/F frequency and voltage cannot be 0 or Max. value).

This function code defines EN500 flexible V/F setting mode to satisfy different load characteristics. 4 kinds of fixed curves and one customized curve can be selected according to definition of F03.00.

When F3.00=0, V/F curve is Constant torque curve feature, as shown in Fig. 7-7a curve 0.

When F03.00=1, V/F curve is 2.0 order power degressive torque characteristic, as shown in Fig. 7-7a curve 3.

When F03.00=2, V/F curve is 1.7 order power degressive torque characteristic, as shown in Fig. 7-7a curve 2.

When F03.00=3, V/F curve is 1.2 order power degressive torque characteristic, as shown in Fig. 7-7a curve 1.

User can choose 1, 2, 3 V/F curve running mode according to load characteristic to reach better energy-saving effect when the inverter drives degressive torque load such as blower and water pump etc.

When F03.00=4, user can set V/F curve by setting F03.04 ~ F03.11 parameter.

As shown in Fig. 7-7b, V/F curve can be defined freely by setting (V1, F1), (V2, F2), (V3, F3), (V4, F4) to meet special load environment.

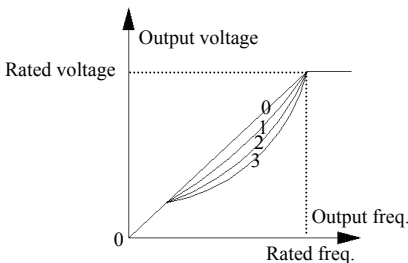
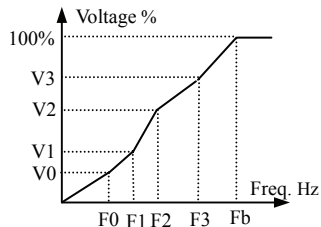

Fig. 7-7 a V/F curve



V0~V3: The 1st-4th voltage percentage of multi section V/F
 F0~F3: The 1st-4th frequency points of multi section V/F
 Fb: Rated frequency

b User-setting V/F curve

F03.01	Torque boost mode	Range:0,1	0
---------------	--------------------------	------------------	----------

0: Manual boost. Torque boost voltage is totally decided by parameter F03.02, whose feature is that the boost voltage is fixed, but magnetic saturation of the motor is occurs often to the light-load.

$$\text{Boost voltage} = \frac{\text{F03.02}}{100} \times \text{motor rated voltage}$$

1: Auto torque boost. Torque boost voltage changes when the stator current of the motor changes, the greater the stator current is, magnetic saturation boost voltage is.

$$\text{Boost voltage} = \frac{\text{F03.02}}{100} \times \text{motor rated voltage} \times \frac{\text{Inverter output current}}{2 \times \text{inverter rated current}}$$

F03.02	Torque boost	Range:0.0~12.0%	Base on motor type
F03.03	Torque boost cut-off frequency	Range:0.0~100.0% (motor rated frequency)	20.0%

Improving inverter torque feature at low frequency can carry on compensation for input voltage, torque boost of smaller than 90KW inverter is 2.0% by default, 90KW and above is 1.0% by default. Degression torque curve and constant torque curve torque boost are as shown in Fig. 7-8a, b.

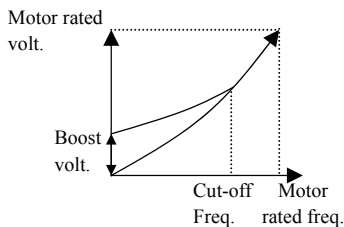

a Degression torque curve Torque boost

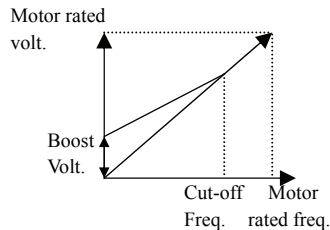

b Constant torque curve Torque boost

Fig. 7-8 Torque boost



Note

1. Improper setting to this parameter can cause motor heating or over current protection.
2. User is advised to adopt manual torque boost and adjust V/F curve according to motor parameter and usage occasion when driving synchronous motor.

F03.04	V/F frequency value 0	Range: 0.00 ~ V/F frequency value 1	10.00Hz
F03.05	V/F voltage value 0	Range: 0.00 ~ V/F voltage value 1	20.00%
F03.06	V/F frequency value 1	Range: V/F frequency value 0 ~ V/F frequency value 2	20.00Hz
F03.07	V/F voltage value 1	Range: V/F voltage value 0 ~ V/F voltage value 2	40.00%
F03.08	V/F frequency value 2	Range: V/F frequency value 1 ~ V/F frequency value 3	25.00Hz
F03.09	V/F voltage value 2	Range: V/F voltage value 1 ~ V/F voltage value 3	50.00%
F03.10	V/F frequency value 3	Range: V/F frequency value 2 ~ upper limit frequency	40.00Hz
F03.11	V/F voltage value 3	Range: V/F voltage value 2 ~ 100.00% (motor rated voltage)	80.00%

F03.04 ~ F03.11 defines multi-step V/F curve. Note that 4 voltage points and frequency points relationship shall be satisfied: $V_0 < V_1 < V_2 < V_3$, $F_0 < F_1 < F_2 < F_3$, for details, please refer to Fig. 7-8b.

If the voltage at low frequency is set too high, motor overheat or even over burning may cause, over current protection may occur to the inverter.

F03.12	V/F oscillation suppression factor	Range:0~255	10
---------------	---	--------------------	-----------

Under V/F control, this parameter can be set properly to prevent motor vibration of the motor. When the inverter operates at low frequency without load, the greater the motor power is, the greater the vibration of motor will be. This parameter can be increased to restrain the vibration of motor. When carrier freq. is smaller, this parameter can be adjusted lower to reduce vibration.

7.5 Auxiliary running parameter group: F04

F04.00	Jump freq. 1	Range:0.00Hz~upper limit frequency	0.00Hz
F04.01	Jump freq. 1 range	Range:0.00Hz~upper limit frequency	0.00Hz
F04.02	Jump freq. 2	Range:0.00Hz~upper limit frequency	0.00Hz
F04.03	Jump freq. 2 range	Range:0.00Hz~upper limit frequency	0.00Hz
F04.04	Jump freq. 3	Range:0.00Hz~upper limit frequency	0.00Hz
F04.05	Jump freq. 3 range	Range:0.00Hz~upper limit frequency	0.00Hz

F04.00 ~ F04.05 is set to keep inverter's output frequency away from resonance frequency of mechanical load.

Inverter setting frequency can jump around some frequency point according to mode as shown in Fig. 7-9, 3 jumping ranges can be defined at most.

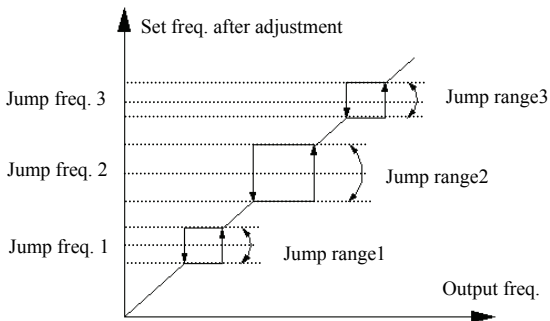

Fig. 7-9 Jump freq. and range

F04.06	Slip freq. gain	Range:0.0~300.0%	0.0%
F04.07	Slip compensation limit	Range:0.0~250.0%	100.0%
F04.08	Slip compensation time constant	Range:0.1~25.0s	2.0s

This function can adjust output frequency properly as the load varies to compensate slip frequency of the asynchronous motor dynamically, so that control motor speed is in constant value. If acting with automatic torque boost function, better low speed moment characteristic can be obtained. As shown in Fig.7-10.

Slip compensation range = Slip compensation limit (F04.06)× Rated slip .

Rated slip = $F15.03 \times 60 / N_p - F15.04$.

N_p is motor polarity.

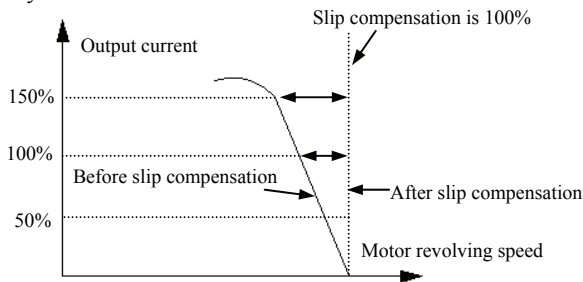

Fig. 7-10 Slip freq. Compensation

F04.09	Carrier freq.	Range:0.5~16.0K	Base on motor type
---------------	----------------------	------------------------	---------------------------

Carrier freq. mainly affects motor noise and heat loss when running. Relationship among carrier freq, motor noise, and leak current is as follows:

When carrier freq. goes up (↑), the motor noise is reduced (↓), leakage current of the motor is increased (↑), and the interference is increased (↑);

When carrier freq. goes down (↓), the motor noise is increased (↑), leakage current of the motor is decreased (↓), and the interference is decreased (↓).

When the ambient temperature is high, and the motor load is heavy, reduce the carrier freq. properly to reduce thermal loss to the inverter.

EN500 all models can set Max. carrier wave as follows:

Table7-1 model and Carrier freq. relationship

Model	Max. Carrier freq.	Factory Default
75~200KW	6KHz	2KHz
220KW and above	4KHz	2KHz



Note

- 1.To get better control characteristic, it is suggested that the ratio of max. running frequency between carrier frequency and inverter be not smaller than 36.
- 2.Error exists in current displayed value when carrier frequency is small.

F04.10	PWM optimized adjustment	Range: LED units digit :0,1 LED tens digit :0,1 LED hundreds digit :0,1 LED thousands digit :0,1	0110
---------------	---------------------------------	---	-------------

LED units digit: Carrier freq. is adjusted automatically according to temperature

0: Banned.

1: Allowed.

Carrier frequency changes based on temperature, which refers to inverter check that the radiator temperature is relatively high, it automatically reduces carrier freq., so as to reduce inverter temperature rise. When radiator temperature is relatively low, carrier freq. gradually restores to set value. This function can reduce inverter overheat alarm.

LED tens digit: low speed carrier freq. limit mode

0: No limit.

1: Limit. Limit carrier wave at low speed, improve stability performance of revolving speed at low speed.

LED hundreds digit: carrier wave modulation system

0: 3 phase modulation.

1: 2 phase and 3 phase modulation.

LED thousands digit: Asynchronous modulation, synchronization mode (valid under V/F control)

0: Asynchronous modulation.

1: Synchronous modulation (under 85Hz: Asynchronous modulation).

- 1. When LED units digit is set as 1, after reaching overheat warning alarm point, carrier wave will decrease to 1.5KHz; when the temperature decrease to 5°C lower than overheat warning alarm point, carrier freq. will automatically rise to the set carrier freq.**
- 2. Synchronous modulation, it means that carrier freq. changes when output frequency changes, it guarantees that the ratio (carrier ratio) between the two does not change, generally used when output frequency is high, conducive to input voltage quality. When output frequency is low (85Hz or below, generally no need of synchronous modulation, so at this time carrier freq. and output frequency ratio is relatively high, advantages of asynchronous modulation are more apparent. When operating frequency is higher than 85Hz, Synchronous modulation is valid, frequency lower than this is fixed with asynchronous modulation mode.**



Note

F04.11	AVR function	Range:0~2	0
---------------	---------------------	------------------	----------

AVR namely automatic voltage regulation function, which indicates that the inverter can output constant voltage by AVR function when the inverter inputs voltage fluctuates.

0: No action

1: Action all the time

2: No action only during deceleration



Note

1. When input voltage is higher than rated value, under normal situation, F04.11=1 shall be set. F02.11= 0 namely inverter is in deceleration stop, motor deceleration time short time running current will be greater. But the motor decrease speed placidly with small run current and long Dec time if choose AVR action all the time.
2. When motor system vibration occurs due to AVR function, set F04.11= 0, namely AVR function is invalid.
3. This function is valid in V/F control mode.

F04.12	Reserved		
---------------	-----------------	--	--

F04.13	Auto energy-saving operation	Range:0,1	0
---------------	-------------------------------------	------------------	----------

0: No action

1: Action

To reach better energy-saving effect, automatic energy-saving purpose can be obtained by checking load current.

When motor runs with no-load or light-load, energy-saving can be realized by checking load current, and properly adjusting input voltage. Auto energy-saving operation is mainly used in applications like stable load and revolving speed.



Note

1. This function is generally used in load like blower and water pump.
2. This function is valid only in V/F mode.

F04.14	Acceleration time 2 and 1 switchover frequency	Range:0.00Hz~upper limit frequency	0.00Hz
F04.15	Deceleration time 2 and 1 switchover frequency	Range:0.00Hz~upper limit frequency	0.00Hz

This function is used in inverter running process, and acceleration/deceleration time shall adopt different high and low speed so as to improve Acceleration/deceleration

performance applications.

In acceleration, if running frequency is smaller than F04.14, select acceleration time 2; if running frequency is greater than F04.14, select acceleration time 1. In deceleration, if running frequency is greater than F04.15, select deceleration time 1, if running frequency is smaller than F04.15, select deceleration time 2.



When using terminal to select acceleration/deceleration time, F04.14 and F04.15 function are invalid.

F04.16	Acceleration time 2	Range:1~60000	200
F04.17	Deceleration time 2	Range:1~60000	200
F04.18	Acceleration time 3	Range:1~60000	200
F04.19	Deceleration time 3	Range:1~60000	200
F04.20	Acceleration time 4	Range:1~60000	200
F04.21	Deceleration time 4	Range:1~60000	200
F04.22	Acceleration time 5	Range:1~60000	200
F04.23	Deceleration time 5	Range:1~60000	200
F04.24	Acceleration time 6	Range:1~60000	200
F04.25	Deceleration time 6	Range:1~60000	200
F04.26	Acceleration time 7	Range:1~60000	200
F04.27	Deceleration time 7	Range:1~60000	200
F04.28	Acceleration time 8	Range:1~60000	200
F04.29	Deceleration time 8	Range:1~60000	200
F04.30	Acceleration time 9	Range:1~60000	200
F04.31	Deceleration time 9	Range:1~60000	200
F04.32	Acceleration time 10	Range:1~60000	200
F04.33	Deceleration time 10	Range:1~60000	200
F04.34	Acceleration time 11	Range:1~60000	200
F04.35	Deceleration time 11	Range:1~60000	200
F04.36	Acceleration time 12	Range:1~60000	200
F04.37	Deceleration time 12	Range:1~60000	200
F04.38	Acceleration time 13	Range:1~60000	200

F04.39	Deceleration time 13	Range:1~60000	200
F04.40	Acceleration time 14	Range:1~60000	200
F04.41	Deceleration time 14	Range:1~60000	200
F04.42	Acceleration time 15	Range:1~60000	200
F04.43	Deceleration time 15	Range:1~60000	200

EN500 defines 15 kinds of acceleration/deceleration time, select acceleration/deceleration time 1 ~ 15 during the inverter running by different combinations of control terminal. Please refer to the definitions of acceleration/deceleration time terminal function in F08.18 ~ F08.25. Cooperating with simple PLC function can also realize each step of PLC adopting different acceleration/deceleration time to complete specific requirements.

The time unit of acceleration/deceleration time 2 ~ 15 above is the same as that of acceleration/deceleration time 1, all are decided by F01.19 parameter of acceleration/deceleration time unit.



Note

Acceleration/deceleration time 1 is defined in F01.17 and F01.18.

7.6 Communication control parameter group: F05

F05.00	Protocol selection	Range:0~4	0
---------------	---------------------------	------------------	----------

0: Modbus protocol .

1: Reserved.

2: Profibus protocol, external expansion card needs to be purchased if needed.

3: CanLink protocol, external expansion card needs to be purchased if needed.

4: CanOpen protocol, external expansion card needs to be purchased if needed.

5: Free protocol 1.

6: Free protocol 2.

F05.01	Baud rate configuration	Range: LED units digit:0~8 LED tens digit:0~3 LED hundreds digit:0~6	005
---------------	--------------------------------	---	------------

F5.01 conFigs communication baud rate when using different communication modules.

LED units digit: Free protocol and Modbus Baud rate selection

0: 300BPS

1: 600BPS

2: 1200BPS

3: 2400BPS

4: 4800BPS

5: 9600BPS

6: 19200BPS

7: 38400BPS

8: 57600BPS

LED tens digit:Reserved

LED hundreds digit: CanLink Baud rate

0: 20K

1: 50K

2: 100K

3: 125K

4: 250K

5: 500K

6: 1M

F05.02	Data format	Range: LED units digit:0~5 LED tens digit :0~3	00
---------------	--------------------	---	-----------

LED units digit: Free protocol and Modbus protocol data format

0: 1-8-1 format, no parity, RTU. 1 for start bit, 8 for data bits, 1 for stop bit, no parity's RTU communication mode.

1: 1-8-1 format, even parity, RTU. 1 for start bit, 8 for data bits, 1 for stop bit, even parity's RTU communication mode.

2: 1-8-1 format, odd parity, RTU. 1 for start bit, 8 for data bits, 1 for stop bit, odd parity's RTU communication mode.

3: 1-7-1 format, no parity, ASCII. 1 for start bit, 7 data bits, 1 for stop bit, no parity's ASCII communication mode.

4: 1-7-1 format, even parity, ASCII. 1 for start bit, 7 data bits, 1 for stop bit, even parity's ASCII communication mode.

5: 1-7-1 format, odd parity, ASCII. 1 for start bit, 7 data bits, 1 for stop bit, odd parity's ASCII communication mode.

LED tens digit: Profibus_DP protocol data format

0: PPO1communication format

1: PPO2communication format

2: PPO3communication format

3: PPO5communication format

F05.03	Local address	Range:0~247	1
---------------	----------------------	--------------------	----------

During serial port communication, this function code is used to identify inverter's address, among which 0 is broadcast address. When setting broadcast address, it can only receive and execute upper computer broadcast command, while cannot respond to upper computer.

F05.04	Communication overtime checkout time	Range:0.0~1000.0s	0.0s
---------------	---	--------------------------	-------------

When serial port communication fails and its continuous time exceed set value of this function code, the inverter judges it as communication failure.

The inverter would not detect serial port communication signal, namely this function ineffective when set value is 0.

F05.05	Communication error checkout time	Range:0.0~1000.0s	0.0s
---------------	--	--------------------------	-------------

When serial port communication fails and its continuous time exceed set value of this function code, the inverter judges it as communication failure.

The inverter would not detect serial port communication signal, namely this function ineffective when set value is 0.

F05.06	Local response delay time	Range:0~200ms	5ms
---------------	----------------------------------	----------------------	------------

Local response delay time represents the time within which the inverter serial port receives and executes command from upper device and then responds to upper device.

F05.07	Main & sub inverter communication frequency setting percentage	Range:0~500%	100%
---------------	---	---------------------	-------------

After setting this parameter proportion when frequency sent from main inverter, as the input source of communication frequency of sub inverter, one inverter can control multiple devices with different proportional frequency.



Note

This parameter is valid only when F5.03= 0, namely only when receiving broadcast command.

F05.08	Communication virtual input terminal enabled	Range:00~FFH	00H
---------------	---	---------------------	------------

- Bit0: CX1 virtual input terminal enabled
- Bit1: CX2 virtual input terminal enabled
- Bit2: CX3 virtual input terminal enabled
- Bit3: CX4 virtual input terminal enabled
- Bit4: CX5 virtual input terminal enabled
- Bit5: CX6 virtual input terminal enabled
- Bit6: CX7 virtual input terminal enabled
- Bit7: CX8 virtual input terminal enabled

F05.09	Communication virtual input terminal joining node	Range:0,1	0
---------------	--	------------------	----------

0: Independent node. Communication virtual terminal function is only set in F05.10 ~ F05.17.

1: Terminal node. Communication virtual terminal function is only set in F08.18 ~ F08.25, regardless of X1 ~ X8 valid, or CX1 ~ CX8 valid all execute this setting function, X1 ~ X8 corresponds to CX1 ~ CX8.

F05.10	Communication virtual terminal CX1 function	Range:0~90	0
F05.11	Communication virtual terminal CX2 function	Range:0~90	0
F05.12	Communication virtual terminal CX3 function	Range:0~90	0
F05.13	Communication virtual terminal CX4 function	Range:0~90	0
F05.14	Communication virtual terminal CX5 function	Range:0~90	0
F05.15	Communication virtual terminal CX6 function	Range:0~90	0
F05.16	Communication virtual terminal CX7 function	Range:0~90	0

F05.17	Communication virtual terminal CX8 function	Range:0~90	0
---------------	--	-------------------	----------

Communication virtual terminal CX1 ~ CX8 function and terminal X1 ~ X8 function is different.

F05.18	Input mapping application parameter 1	Range:F00.00~F26.xx	25.00
F05.19	Input mapping application parameter 2	Range:F00.00~F26.xx	25.00
F05.20	Input mapping application parameter 3	Range:F00.00~F26.xx	25.00
F05.21	Input mapping application parameter 4	Range:F00.00~F26.xx	25.00
F05.22	Input mapping application parameter 5	Range:F00.00~F26.xx	25.00
F05.23	Input mapping application parameter 6	Range:F00.00~F26.xx	25.00
F05.24	Input mapping application parameter 7	Range:F00.00~F26.xx	25.00
F05.25	Input mapping application parameter 8	Range:F00.00~F26.xx	25.00
F05.26	Input mapping application parameter 9	Range:F00.00~F26.xx	25.00
F05.27	Input mapping application parameter 10	Range:F00.00~F26.xx	25.00

Input parameter address mapping.

This parameter is used for mapping waiting for input. Integral part corresponds with group no. of the parameter, while decimal part corresponds with intra-class reference (parameter series no. within group parameter). For example: Setting F05.18=00.00 indicates that mapping F05.18=00.00 as input parameter 1.



Note

1. xx represents function code.
2. F25.xx represents not mapping.



Note

If you need to read two or more discontinuous parameters by communication, you can use input mapping application parameter to improve communication efficiency. For example, if reading F0.00, F1.10, F2.02 and F3.04, you can map the above-mentioned parameters to F05.18, F05.19, F05.20, F05.21 and F05.22. Under RTU communication mode, only 1 continuous reading 5 groups of parameter commands (01 03 05 12 00 05 24 D1) can read 5 groups of parameter values, thus improving communication efficiency.

7.7 Setting curve parameter group: F06

F06.00	Setting curve selection	Range: LED units digit:0~2 LED tens digit:0~2 LED hundreds digit :0~2 LED thousands digit 0~2	0000
---------------	--------------------------------	--	-------------

LED units digit: AI1 curve selection

0: curve 1.

1: curve 2.

2: curve 3.

LED tens digit: AI2 curve selection

Same as units digit.

LED hundreds digit: rapid pulse curve selection

Same as units digit.

LED thousands digit: Pulse width setting curve selection

Same as units digit.

This function code tens digit, hundreds digit and thousands digit are used to select analog quantity input AI1, AI2, rapid pulse input and pulse width input signal setting curve. Curve 1 and 2 are 3 point curve, curve 3 is 4 point curve. User can select different curves for adjustment based on characteristic requirement of the input signal so as to realize specific input.

F06.01	Curve 1 min. setting	Range: 0.0% ~ curve 1 Inflexion setting	0.0%
F06.02	Corresponding physical quantity of curve 1 min. setting	Range: 0.0 ~ 100.0%	0.0%
F06.03	Curve 1 inflexion setting	Range: curve 1 min. setting ~ curve 1 Max. setting	50.0%
F06.04	Corresponding physical quantity of curve 1 inflexion setting	Range: 0.0 ~ 100.0%	50.0%
F06.05	Curve 1 Max. setting	Range: curve 1 inflexion setting ~100.0%	100.0%
F06.06	Corresponding physical quantity of curve 1 Max. setting	Range: 0.0 ~ 100.0%	100.0%
F06.07	Curve 2 min. setting	Range: 0.0% ~ curve 2 inflexion setting	0.0%
F06.08	Corresponding physical quantity of curve 2 min. setting	Range: 0.0 ~ 100.0%	0.0%
F06.09	Curve 2 inflexion setting	Range: curve 2 min. setting ~ curve 2 Max. setting	50.0%

F06.10	Corresponding physical quantity of curve 2 inflexion setting	Range: 0.0 ~ 100.0%	50.0%
F06.11	Curve 2 Max. setting	Range: curve 2 inflexion setting ~ 100.0%	100.0%
F06.12	Corresponding physical quantity of curve 2 Max. setting	Range: 0.0 ~ 100.0%	100.0%
F06.13	Curve 3 min. setting	Range: 0.0% ~ curve 3 inflexion 1 setting	0.0%
F06.14	Corresponding physical quantity of curve 3 min. setting	Range: 0.0 ~ 100.0%	0.0%
F06.15	Curve 3 inflexion 1 setting	Range: curve 3 min. setting ~ curve 3 inflexion 2 setting	30.0%
F06.16	Corresponding physical quantity of curve 3 inflexion 1 setting	Range: 0.0 ~ 100.0%	30.0%
F06.17	Curve 3 inflexion 2 setting	Range: curve 3 inflexion 1 setting ~ curve 3 Max. setting	60.0%
F06.18	Corresponding physical quantity of curve 3 inflexion 2 setting	Range: 0.0 ~ 100.0%	60.0%
F06.19	Curve 3 Max. setting	Range: curve 3 inflexion 1 setting ~100.0%	100.0%
F06.20	Corresponding physical quantity of curve 3 Max. setting	Range: 0.0 ~ 100.0%	100.0%

Take curve 1 as an example:

Parameter F06.01 ~ F06.06 is used to set analog quantity input voltage and its representative set value relationship. When analog quantity input voltage is greater than the set “Max. input”(F06.05), analog quantity voltage is calculated based on “Max. input”; similarly, When analog input voltage is smaller than the set “ min. input ”(F06.01), Set based on “ curve lower than min. input setting selection”(F06.21), calculated by min. input or 0.0%.



Note

1. For function and usage of curve 2, please refer to curve 1 instruction.
2. Curve 3 function is similar to curve 1 and curve 2, but curve 1 and 2 are three-point straight line, while curve 3 is four-point curve, which can realize more flexible corresponding relationship.
3. The output positive/negative polarity of curve 1, 2, 3 is decided by the features of input analog signal. Curve will not change output positive/negative polarity.
4. As frequency setting, 100.0% setting corresponding physical quantity is upper limit frequency F01.11.

F06.21	Curve lower than min. input corresponding selection	Range: LED units digit:0,1 LED tens digit:0,1 LED hundreds digit:0,1 LED thousands digit:0,1 LED ten thousands digit:0,1	11111
---------------	--	---	--------------

LED units digit: curve 1 setting

0: Corresponds to min. setting corresponding physical quantity.

1: 0.0% of the corresponding physical quantity.

LED tens digit: curve 2 setting

Same as units digit.

LED hundreds digit: curve 3 setting

Same as units digit.

LED thousands digit: extended curve 1

Same as units digit.

LED ten thousands digit: extended curve 2

Same as units digit.

This parameter is used to set, when curve's corresponding analog quantity input voltage is smaller than the min. setting, how to decide corresponding setting analog quantity.

For example, F06.21 units=0, when analog quantity input is lower than F06.01, this curve output F06.02 corresponding physical quantity value. If F06.21 units=1, when analog quantity input is lower than F06.01, this curve output is 0.

Take 0 ~ 10V A11 for setting frequency as an example: A11 selects curve 1, setting frequency and A11 relationship as shown in Fig. 7-11.

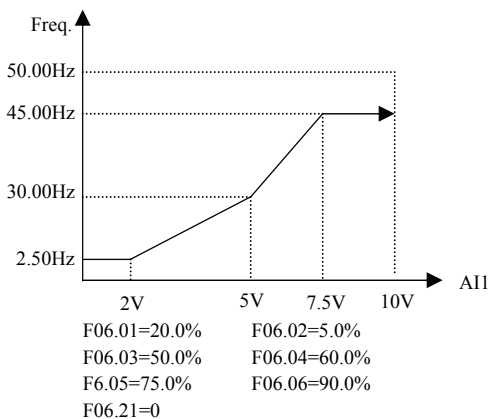

Fig. 7-11 AI1 selects curve 1 frequency setting

7.8 Analog quantity, Pulse input function parameter group: F07

F07.00	A11 input filter time	Range:0.000~9.999s	0.050s
F07.01	A11 setting gain	Range:0.000~9.999	1.004
F07.02	A11 setting bias	Range:0.0~100.0%	0.5%

A11 input filter time, is used to set A11 software filter time. When field analog quantity is easily interrupted, increase filter time to make the analog quantity check stable, but when filter time is greater, the response time of analog quantity check is slower. Please set according to the actual situation.

A11 setting bias is indicated with Max. input (10V or 20mA) percentage, which is used to set up and down translation quantity of A11 analog input. Take voltage input, bias positive as an example, the adjustment relationship of setting bias and gain adjustment before and after adjustment is as follows:

$$\text{Analog input AI1 (after correction)} = \text{input gain (F07.01)} \times \text{Analog input AI1 (before correction)} + \text{Setting bias (F07.02)} \times 10\text{V}$$

Set the input current and the positive bias as an example, the relationship between setting bias and gain(before&after adjustment) is as follows:

$$\text{Analog input AI1 (after correction)} = \text{input gain (F07.01)} \times \text{Analog input AI1 (before correction)} + \text{Setting bias (F07.02)} \times 20\text{mA}$$

F07.03	A12 input filter time	Range:0.000~9.999s	0.050s
F07.04	A12 setting gain	Range:0.000~9.999	1.003
F07.05	A12 setting bias	Range:0.0~100.0%	0.1%

Parameter F7.03 ~ F7.05 is used to set analog quantity input AI2 filter time , gain and setting bias, For detail using method, please refer to analog quantity input A11. Take voltage input, bias positive as an example, the adjustment relationship of setting bias and gain adjustment before and after adjustment:

$$\text{Analog input AI2 (after correction)} = \text{input gain (F07.04)} \times \text{Analog input AI2 (before correction)} + \text{Setting bias (F07.05)} \times 10\text{V}$$

Set the input current and the positive bias as an example, the relationship between setting bias and gain(before&after adjustment) is as follows:

$$\text{Analog input AI2 (after correction)} = \text{input gain (F07.04)} \times \text{Analog input AI2 (before correction)} + \text{Setting bias (F07.05)} \times 20 \text{ mA}$$

F07.06	Analog setting bias polarity	Range: LED units digit:0,1 LED tens digit:0,1	01
---------------	-------------------------------------	--	-----------

LED units digit: AI1 setting bias polarity

0: Positive polarity.

1: Negative polarity.

LED tens digit: AI2 setting bias polarity

0: Positive polarity.

1: Negative polarity.

Parameter F07.06 is used to set analog quantity AI1 and when AI2 counts the polarity of bias. Take voltage input as an example, when F07.06 units are set as 0:

Analog input AI1 (after correction) = input gain (F07.01) × Analog input AI1 (before correction) + Setting bias (F07.02) × 10V

When F7.06 units are set as 1:

Analog input AI1 (after correction) = input gain (F07.01) × Analog input AI1 (before correction) - Setting bias (F07.02) × 10V

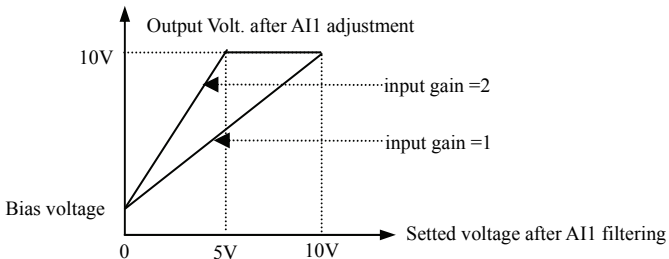

Fig. 7-12 AI1 adjustment

F07.07	Pulse input filter time	Range:0.000~9.999s	0.000s
F07.08	Pulse input gain	Range:0.000~9.999	1.000
F07.09	Pulse input Max. frequency	Range:0.01~50.00KHz	10.00KHz

F07.07, F07.08 parameter defines filter time and gain when frequency channel selection terminal pulse is set. When setting filter time, Please be noted that the longer the filter time is, the slower the change rate of output frequency is. So set filter time properly according to the actual situation.

F7.09 parameter defines frequency input range when frequency setting channel selection terminal pulse is set. When actual input frequency is greater than the set Max. frequency, deal with it according to Max. frequency.

F07.10	Pulse width input filter time	Range:0.000~9.999s	0.000s
F07.11	Pulse width input gain	Range:0.000~9.999	1.000
F07.12	Pulse width input logic setting	Range:0,1	0
F07.13	Pulse width Max. input width	Range:0.1~999.9ms	100.0ms

F07.10, F07.11 parameter defines filter time and gain when frequency channel selection terminal pulse width is set. When setting filter time, Please be noted that when the Max. pulse width set in F07.13 is smaller, the filter time is not suggested to be set too long, otherwise the response time of output frequency will be very slow.

0: Positive logic.

1: Negative logic.

F07.12 defines valid level of digital quantity input X8 channel input pulse when frequency channel selection terminal pulse width is set. The applications shall go with double polarity working state of X input terminal.

F07.13 parameter defines the width range of input valid pulse when frequency setting channel selection terminal pulse width is set.

F07.14	Reserved		
F07.15	Reserved		
F07.16	Reserved		
F07.17	Reserved		

7.9 On-off input function parameter group: F08

F08.00	Input terminal positive and negative logic setting	Range:0000~FFFF	0000
---------------	---	------------------------	-------------

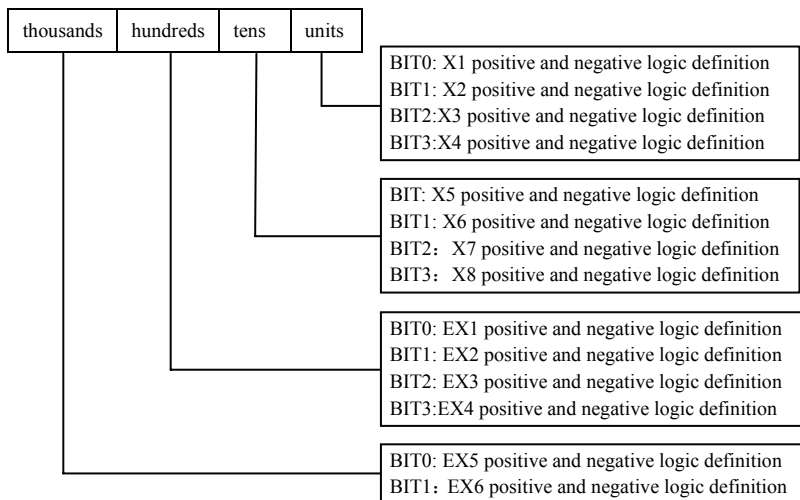

The setting of this parameter is finally converted to binary setting, relationship between binary setting and hexadecimal is as shown in table 7-2.

Table 7-2 Relationship between binary setting and LED bit displayed value

Binary setting				Hexadecimal (LED bit displayed value)
BIT3	BIT2	BIT1	BIT0	
0	0	0	0	0
0	0	0	1	1
0	0	1	0	2
0	0	1	1	3
0	1	0	0	4
0	1	0	1	5
0	1	1	0	6
0	1	1	1	7
1	0	0	0	8
1	0	0	1	9
1	0	1	0	A
1	0	1	1	B
1	1	0	0	C
1	1	0	1	D

1	1	1	0	E
1	1	1	1	F

LED bit refers to units, tens, hundreds or thousands displayed on LED in operation panel.

F08.00 parameter defines valid logic state of Xi input terminal:

Positive logic: Xi terminal and corresponding common port closed valid, opened invalid;

Negative logic: Xi terminal and corresponding common port closed invalid, opened valid;

When bit selects 0, it indicates positive logic; 1 indicates negative logic. Proper setting of this parameter can realize correct logic input without changing terminal wiring.

F08.01	Input terminal filter time	Range:0.000~1.000s	0.000s
---------------	-----------------------------------	---------------------------	---------------

F08.01 parameter sets filter time of input terminal check. When input terminal state is changed, the terminal state change is valid only when the set filter time is unchanged. Otherwise, it will remain the last state, thus effectively reduce malfunction caused by interruption.

F08.02	X1 Input terminal closed time	Range:0.00~99.99s	0.00s
F08.03	X1 Input terminal opened time	Range:0.00~99.99s	0.00s
F08.04	X2 Input terminal closed time	Range:0.00~99.99s	0.00s
F08.05	X2 Input terminal opened time	Range:0.00~99.99s	0.00s
F08.06	X3 Input terminal closed time	Range:0.00~99.99s	0.00s
F08.07	X3 Input terminal opened time	Range:0.00~99.99s	0.00s
F08.08	X4 Input terminal closed time	Range:0.00~99.99s	0.00s
F08.09	X4 Input terminal opened time	Range:0.00~99.99s	0.00s
F08.10	X5 Input terminal closed time	Range:0.00~99.99s	0.00s
F08.11	X5 Input terminal opened time	Range:0.00~99.99s	0.00s
F08.12	X6 Input terminal closed time	Range:0.00~99.99s	0.00s
F08.13	X6 Input terminal opened time	Range:0.00~99.99s	0.00s
F08.14	X7 Input terminal closed time	Range:0.00~99.99s	0.00s
F08.15	X7 Input terminal opened time	Range:0.00~99.99s	0.00s
F08.16	X8 Input terminal closed time	Range:0.00~99.99s	0.00s
F08.17	X8 Input terminal opened time	Range:0.00~99.99s	0.00s

F08.02 ~ F08.17 parameter defines the corresponding delay time of Xi input terminal from closed to opened or opened to closed so as to meet user's multiple requirements.

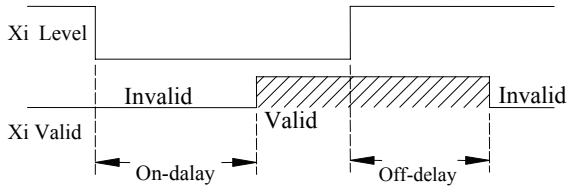

Fig. 7-13 closed and opened delay

F08.18	Input terminal X1 function selection	Range:0~95	1
F08.19	Input terminal X2 function selection	Range:0~95	2
F08.20	Input terminal X3 function selection	Range:0~95	0
F08.21	Input terminal X4 function selection	Range:0~95	0
F08.22	Input terminal X5 function selection	Range:0~95	0
F08.23	Input terminal X6 function selection	Range:0~95	0
F08.24	Input terminal X7 function selection	Range:0~95	0
F08.25	Input terminal X8 function selection	Range:0~95	0

Multi-functional input terminal X1 ~ X8 provides users with up to 95 selections, which can be selected based on actual applications. For details, please refer to parameter function Table 7-3.

Table 7-3 Multi-functional input selection function table

Content	Function	Content	Function
0	Leave control terminal unused	48	Auxiliary frequency reset
1	Forward running FWD terminal	49	Command switchover to panel
2	Reverse running REV terminal	50	Command switchover to terminal
3	External forward jogging control	51	Command switchover to communication
4	External reverse jogging control	52	Running command Channel selection terminal 1
5	Multi-step speed control terminal 1	53	Running command Channel selection terminal 2
6	Multi-step speed control terminal 2	54	Forward prohibited command (Stop according to the stop mode, invalid for jogging command)

7	Multi-step speed control terminal 3	55	Reverse prohibited command (Stop according to the stop mode, invalid for jogging command)
8	Multi-step speed control terminal 4	56	Swinging frequency input
9	Acceleration/deceleration time selection terminal 1	57	Resetting state of swinging frequency
10	Acceleration/deceleration time selection terminal 2	58	Interior counter reset end
11	Acceleration/deceleration time selection terminal 3	59	Interior counter input end
12	Acceleration/deceleration time selection terminal 4	60	Internal timer resetting
13	Main and auxiliary frequency operational rule selection terminal 1	61	Internal timer triggering
14	Main and auxiliary frequency operational rule selection terminal 2	62	Length count input
15	Main and auxiliary frequency operational rule selection terminal 3	63	Length reset
16	Frequency ascending command (UP)	64	Reset this operation time
17	Frequency descending command (DOWN)	65	Reserved
18	Frequency ascending/descending frequency resetting	66	Reserved
19	Multi-step closed loop terminal 1	67	Reserved
20	Multi-step closed loop terminal 2	68	Reserved
21	Multi-step closed loop terminal 3	69	Reserved
22	External equipment failure input	70	Reserved
23	External interruption input	71	Reserved
24	External resetting input	72	Reserved
25	Free stop input	73	Reserved
26	External stop instruction—Stop according to the stop mode	74	Reserved
27	stop DC braking input command DB	75	Reserved
28	inverter running prohibited—Stop according to the stop mode	76	Reserved
29	Acceleration/deceleration prohibited command	77	Reserved
30	Three-wire running control	78	Reserved
31	Process PID invalid	79	Reserved
32	Process PID stop	80	Reserved
33	Process PID integral holding	81	Reserved
34	Process PID integral resetting	82	Reserved
35	Process PID function negation (Closed loop adjustment feature negation)	83	Reserved

36	Simple PLC invalid	84	Reserved
37	Simple PLC halted	85	Reserved
38	Simple PLC stop state resetting	86	Reserved
39	Main frequency switchover to digit (keypad)	87	Reserved
40	Main frequency switchover to AI1	88	Reserved
41	Main frequency switchover to AI2	89	Reserved
42	Main frequency switchover to EA11	90	Reserved
43	Main frequency switchover to EA12	91	Pulse frequency input (X8 VALID)
44	Main frequency setting channel selection terminal 1	92	Pulse width PWM INPUT (X8 VALID)
45	Main frequency setting channel selection terminal 2	93	Reserved
46	Main frequency setting channel selection terminal 3	94	Reserved
47	Main frequency setting channel selection terminal 4	95	Reserved

Function introduction in Table 7-3 is as shown below:

1, 2: External command terminal. When running command channel is terminal running command, control inverter's forward and reverse by external terminal.

3, 4: External jogging command terminal. Set as any running command channel setting running command, control inverter's jogging forward and jogging reverse by external terminal.

5 ~ 8: Multi-step running terminal. By setting these functions' terminal ON/OFF combination, up to 15 multi-step running frequencies can be set.

Table 7-4 Multi-step running selection table

K ₄	K ₃	K ₂	K ₁	Frequency setting
OFF	OFF	OFF	OFF	Other running frequencies
OFF	OFF	OFF	ON	Multi-step frequency 1
OFF	OFF	ON	OFF	Multi-step frequency 2
OFF	OFF	ON	ON	Multi-step frequency 3
OFF	ON	OFF	OFF	Multi-step frequency 4
OFF	ON	OFF	ON	Multi-step frequency 5
OFF	ON	ON	OFF	Multi-step frequency 6
OFF	ON	ON	ON	Multi-step frequency 7
ON	OFF	OFF	OFF	Multi-step frequency 8
ON	OFF	OFF	ON	Multi-step frequency 9
ON	OFF	ON	OFF	Multi-step frequency 10
ON	OFF	ON	ON	Multi-step frequency 11
ON	ON	OFF	OFF	Multi-step frequency 12
ON	ON	OFF	ON	Multi-step frequency 13

ON	ON	ON	OFF	Multi-step frequency 14
ON	ON	ON	ON	Multi-step frequency 15

When using multi-step speed to run and simple PLC to run, use multi-step speed frequency (F10.31 ~ F10.45) above, take multi-step speed running as an example:

Define control terminal X1, X2, X3, X4:

When F08.18=5, F08.19=6, F08.20=7, F08.21= 8, X1, X2, X3, X4 are used to define multi-step speed running, as shown in Fig. 7-14.

Fig. 7-14 takes terminal running command channel as an example, X5 is set as forward terminal, X6 is reverse terminal, to control by forward and reverse running.

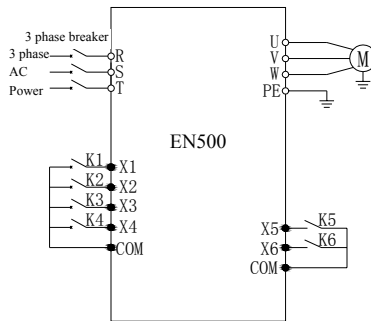

Fig. 7-14 Multi-step speed running wiring

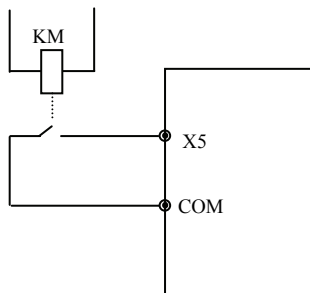

Fig. 7-15 Peripheral equipment fault Normally Open

9 ~ 12: Acceleration/deceleration time terminal selection. By ON/OFF of acceleration/deceleration time terminal, acceleration/deceleration time 1 ~ 15 can be selected. For details, see Table 7-5:

Table 7-5 Acceleration/deceleration time terminal selection

Acceleration/ deceleration time selection terminal 4	Acceleration/ deceleration time selection terminal 3	Acceleration/ deceleration time selection terminal 2	Acceleration/ deceleration time selection terminal 1	Acceleration/deceleration time selection
OFF	OFF	OFF	ON	Acceleration/deceleration time 1
OFF	OFF	ON	OFF	Acceleration/deceleration time 2
OFF	OFF	ON	ON	Acceleration/deceleration time 3
OFF	ON	OFF	OFF	Acceleration/deceleration time 4
OFF	ON	OFF	ON	Acceleration/deceleration time 5
OFF	ON	ON	OFF	Acceleration/deceleration time 6
OFF	ON	ON	ON	Acceleration/deceleration time 7
ON	OFF	OFF	OFF	Acceleration/deceleration time 8
ON	OFF	OFF	ON	Acceleration/deceleration time 9
ON	OFF	ON	OFF	Acceleration/deceleration time 10
ON	OFF	ON	ON	Acceleration/deceleration time 11
ON	ON	OFF	OFF	Acceleration/deceleration time 12
ON	ON	OFF	ON	Acceleration/deceleration time 13
ON	ON	ON	OFF	Acceleration/deceleration time 14
ON	ON	ON	ON	Acceleration/deceleration time 15

13 ~ 15: Main and auxiliary frequency operational rule selection terminal. By ON/OFF of frequency setting channel selection terminal 13, 14, and 15, 7 kinds of main and auxiliary frequency operational rules defined in F01.06 parameter can be realized. Switchover between main and auxiliary operational rule terminal is prior to function code F01.06 setting. For details, please see table 7-6:

Table 7-6 Selection table of terminal main and auxiliary frequency operational rule

Main and auxiliary operational rule selection terminal 3	Main and auxiliary operational rule selection terminal 2	Main and auxiliary operational rule selection terminal 1	Main and auxiliary operational rule selection
OFF	OFF	OFF	Decided by F01.06
OFF	OFF	ON	Synthesized frequency is sub-frequency
OFF	ON	OFF	Operation rule: addition
OFF	ON	ON	Operation rule: subtraction
ON	OFF	OFF	Operation rule: multiplication
ON	OFF	ON	Synthesized frequency is Max. value
ON	ON	OFF	Synthesized frequency is min. value
ON	ON	ON	Synthesized frequency is nonzero value

16, 17: Frequency ascending command UP/descending command DOWN. Realize frequency ascending or descending by control terminal, substitute operation keypad for remote control. Normal running F01.00 or F01.03 set as 3 is valid. Ascending/descending rate is set in F18.06 and F18.07.

18: Frequency ascending/descending frequency resetting.

When frequency setting is set as terminal UP/DOWN, this terminal can eliminate the set frequency value by terminal UP/DOWN.

19 ~ 21: Multi-step closed loop setting terminal. By ON/OFF of multi-step closed loop setting terminal, Table 7-7 Multi-step closed loop setting selection can be realized.

Table 7-7 Multi-step closed loop setting selection table

Multi-step closed loop setting selection terminal 3	Multi-step closed loop setting selection terminal 2	Multi-step closed loop setting selection terminal 1	Multi-step closed loop setting selection
OFF	OFF	OFF	Closed loop setting decided by F11.01
OFF	OFF	ON	Multi-step closed loop setting 1
OFF	ON	OFF	Multi-step closed loop setting 2
OFF	ON	ON	Multi-step closed loop setting 3
ON	OFF	OFF	Multi-step closed loop setting 4
ON	OFF	ON	Multi-step closed loop setting 5
ON	ON	OFF	Multi-step closed loop setting 6
ON	ON	ON	Multi-step closed loop setting 7

22: External equipment failure jump-in. with this terminal, peripheral equipment fault signal can be input, which is convenient for inverter to perform fault monitoring for peripheral equipment, as shown in Fig. 7-15.

23: External interruption input. When the inverter is running, after receiving external interruption signal, it blocks output, and runs with zero frequency. Once external interruption signal is released, and inverter running command is still valid, inverter auto revolving speed tracking starts, the inverter restarts.

24: External resetting input. When fault alarm occurs to the inverter, you can reset fault by this terminal. Its function and operation keypad  key function are in accordance.

25: Free stop input. The purpose of this function and free stop set in F02.11

is the same, but here it uses control terminal to realize, which is convenient for remote control.

26: External stop instruction. This command is effective for all running command channel, when this function terminal is effective, the inverter stops running according to mode set by F2.11.

27: Stop DC braking input command DB. Implement DC braking to the motor during stop by control terminal so as to realize emergency stop and accurate position of the motor. During deceleration stop, If this function terminal closed, when frequency is lower than the brake starting frequency F02.14, it will brake according to brake current defined in F02.16. It will not stop until terminal is opened.

28: Inverter running prohibited. The inverter during running stops freely. When this terminal is effective and forbidden to start in waiting status, mainly applied to occasion needing safe linkage.

29: Acceleration/deceleration prohibited command. When this function is valid, keep the motor away from any external signal (except stop command), maintain current revolving speed running.



Note

This function is invalid in normal deceleration stop process.

30: Three-wire running control. Refer to F08.26 operating mode (Three-wire operating mode) function introduction.

31: Process PID invalid. Realize flexible switchover in low-level running mode under closed-loop running status.



Note

- 1, Switchover between closed-loop and low level running mode can be available only when the inverter runs in closed-loop mode (F11.00=1 or F12.00=1).
- 2, When switching to low-level running mode, start-stop control, direction and acceleration/deceleration time comply with relevant setting of running mode.

32: Process PID stop. Invalid when PID stops, when inverter maintains current output frequency, PID regulation of frequency source is no more performed.

33: Process PID integral holding. PID integral impact maintains, and will not regulate according to the output quantity.

34: Process PID integral resetting. When the terminal is valid, PID integral regulation function halts, but PID proportional control and differential control

function are still valid.

35: Process PID function negation. When the terminal is valid, direction of PID effect and setting direction of F11.13 is opposite.

36: simple PLC invalid. Realize flexible switchover in low-level running mode under PLC running status.



Note

1, Switchover between PLC and low level running mode can be available only when the inverter runs in PLC mode (F10.00 unit's digit is not 0).

2, When switching to low-level running mode, start-stop control, direction and acceleration/deceleration time comply with relevant setting of running mode.

37: Simple PLC halted. It is to control the stop of running PLC, when the terminal is valid, the inverter runs at zero frequency, PLC running does not time; after invalid implementation, auto revolving speed tracking starts and keep on running PLC.

38: Simple PLC stop state resetting. Under stop status of PLC running mode, will clear PLC run step, runtime, run frequency etc. recorded when PLC running stops if this terminal is effective, please see F10 group function description.

39: Main frequency switchover to digital setting (keypad). When this terminal is valid, the main frequency setting channel switchover to keypad digital setting (by keypad up and down key setting frequency).

40: Main frequency switchover to AI1. When this terminal is valid, the main frequency setting channel switchover to analog quantity AI1 setting.

41: Main frequency switchover to AI2. When this terminal is valid, the main frequency setting channel switchover to analog quantity AI2 setting.

42: Main frequency switchover to EAI1. When extended analog quantity is valid, when this terminal is valid, the main frequency setting channel switchover to extended analog quantity EAI1 setting.

43: Main frequency switchover to EAI2. When extended analog quantity is valid, when this terminal is valid, the main frequency setting channel switchover to extended analog quantity EAI2 setting.

44 ~ 47: Main frequency setting channel selection terminal. By ON/OFF of selection terminal 1 ~ 4, Free selection of main frequency setting channel can be realized by terminal. The priority of main frequency setting channel selection terminal (terminal function 44 ~ 47) is higher than the main frequency switchover to (terminal function 41, 42, 43). For details, see table 7-8.

Table 7-8 Main frequency setting channel selection terminal

Channel selection terminal 4	Channel selection terminal 3	Channel selection terminal 2	Channel selection terminal 1	main frequency setting channel selection terminal
OFF	OFF	OFF	ON	Operation keypad digital setting
OFF	OFF	ON	OFF	AI1 analog setting
OFF	OFF	ON	ON	AI2 analog setting
OFF	ON	OFF	OFF	Terminal UP/DOWN setting
OFF	ON	OFF	ON	Communication setting
OFF	ON	ON	OFF	EA11 analog setting (extended)
OFF	ON	ON	ON	EA12 analog setting (extended)
ON	OFF	OFF	OFF	rapid pulse setting (X8)
ON	OFF	OFF	ON	Pulse width setting (X8)
ON	OFF	ON	OFF	Terminal encoder setting (X1, X2)
ON	OFF	ON	ON	Keypad analog potentiometer setting (optional)
ON	ON	OFF	OFF	Reserved
ON	ON	OFF	ON	Reserved
ON	ON	ON	OFF	Reserved

48: Auxiliary frequency reset. Only valid for digit auxiliary frequency, when this function terminal is valid, reset auxiliary frequency setting quantity, setting frequency is completely decided by main frequency setting channel.

49: Command switchover to panel. When current command source is reset by terminal or communication, switchover between current command source and keypad command setting can be realized by this terminal.

50: Command switchover to terminal. When current command source is reset by keypad or communication, switchover between current command source and terminal command setting can be realized by this terminal.

51: Command switchover to communication. When current command source is reset by keypad or terminal, switchover between current command source and communication command setting can be realized by this terminal.

52, 53: Running command Channel selection terminal. For details, please refer to Table 7-9.

Table 7-9 Running command channel logic mode

Running command channel selection terminal 2	Running command channel selection terminal 1	Running command channel
OFF	OFF	Invalid
OFF	ON	Operation keypad running command channel

ON	OFF	Terminal running command channel
ON	ON	Communication running command channel

54: Forward prohibited command. Enable this terminal during the forward running process, and the inverter stops according to the stop mode. First enable this terminal, and then forward running enters zero frequency running status. Jogging running is not affected by this.

55: Reverse prohibited command. Function and “Forward prohibited command” are opposite.

56: Swinging frequency input. When the starting mode of swinging frequency is manual input, this terminal is valid, and swinging frequency function is valid. See F13 group function parameter instruction. When swinging frequency is set as manual input, this terminal is invalid, run with preset frequency of swinging frequency.

57: Resetting state of swinging frequency. When selecting swinging frequency function, no matter auto or manual input mode, closing this terminal will clear state information of swinging frequency memorized in the inverter. When opening this terminal, swinging frequency restarts. For details, please see F13 group function.

58: Interior counter reset end. Reset inverter built-in counter, and go with counter triggering signal input. For details, please see parameter F08.27, F08.28.

59: Interior counter input end. Interior counter’s counting pulse input port, pulse max. frequency: 50.0KHz.

60: Interior timer reset end. Reset inverter built-in timer, goes with timer triggering-end signal input.

61: Interior timer triggering end. See parameter F08.29 function.

62: Length count input. Length counting input terminal, see fixed length function of F13 group parameter.

63: Length reset. When the terminal is valid, reset internal length value, see F13 fixed length function of parameter group.

64: Reset this operation time. When the terminal is valid, the running counting time of this inverter is reset, see timing running defined in F18 group.

65 ~ 90: Reserved

91: Pulse frequency input (X8 valid). Only valid for multi-functional input terminal X8, this function terminal accepts pulse signal as frequency setting, relationship between the input signal pulse frequency and setting frequency is as shown in F06 and F07 group parameter.

92: Pulse width PWM input (X8 valid). Only valid for multi-functional

input terminal X8, this function terminal accepts PWM signal, check pulse width as frequency setting, relationship between input PWM Pulse width and setting frequency is as shown in F06 and F07 group parameter.

93~96: Reserved

F08.26	FWD/REV operating mode selection	Range:0~4	0
---------------	---	------------------	----------

This parameter defines five different modes by controlling external terminal inverter running.

0: Two-wire control mode 1

K2	K1	Operating command
0	0	Stop
1	0	REV
0	1	FWD
1	1	Stop

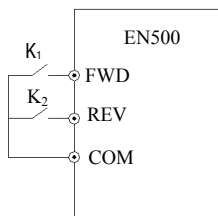

Fig. 7-16 Two-wire operating mode 1

1: Two-wire control mode 2

K2	K1	Operating command
0	0	Stop
1	0	Stop
0	1	FWD
1	1	REV

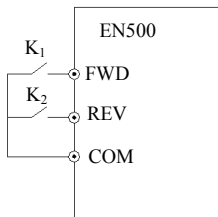

Fig. 7-17 Two-wire operating mode 2

2: Two-wire control mode 3 (monopulse control mode)

Monopulse control is triggered-type control. After triggering SB1 once, it forwards runs. Retriggering SB1 once, it stops. Triggering SB1 once, it reversely runs. Retriggering SB2 once, it stops. If it is forward running, the inverter stops when triggering SB2 once. Retriggering SB1 once, it stops. If it is reverse running, the inverter stops when triggering SB1 once.

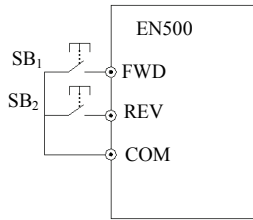

Fig. 7-18 Two-wire control mode 3

3: Three-wire control mode 1

Defines are as follows:

SB1: stop button

SB2: forward button

SB3: reverse button

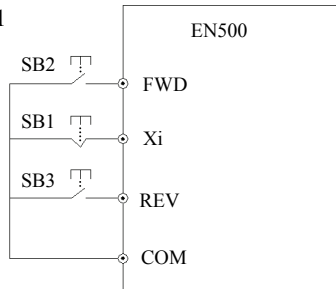

Fig. 7-19 Three-wire operating mode 1

X_i is $X_1 \sim X_8$'s Multi-functional Input terminal, at this moment, define its corresponding terminal function as “Three-wire running control” function of No.30.

4: Three-wire control mode 2

SB1: stop button

SB2: run button

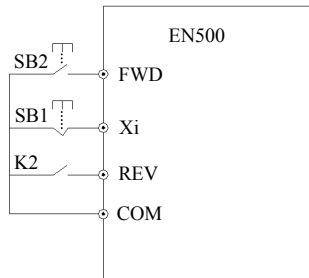

K2	Running direction selection
0	Forward
1	Reverse

Fig. 7-20 Three-wire operating mode 2

X_i is $X_1 \sim X_8$'s Multi-functional input terminal, At this moment, define its corresponding terminal function as “Three-wire running control” function of No.

30.

F08.27	Set internal count value to setting	Range:0~65535	0
F08.28	Specify internal count to setting	Range:0~65535	0

F08.27 and F08.28 are to additionally define functions of 30 and 31 in 7-10.

When Xi (Counting trigger signal input function terminal) output pulse reaches F08.27 defined value, Y1 (Y1 is set as internal count value final value to) outputs one indicating signal, as shown in Fig. 7-21, When Xi inputs the eighth pulse, Y1 outputs one indicating signal. At this moment, F08.27=8.

When Xi (Counting trigger signal input function terminal) output pulse reaches F08.28 defined value, Y2 (Y2 is set as internal counter specified value to) outputs one indicating signal, until set count value arrives.

As shown in Fig. 7-21, when Xi inputs the fifth pulse, Y2 starts outputting one indicating signal. Until set count value 8 arrives, F08.28=5. When specified count value is greater than set count value, specified count value Invalid.

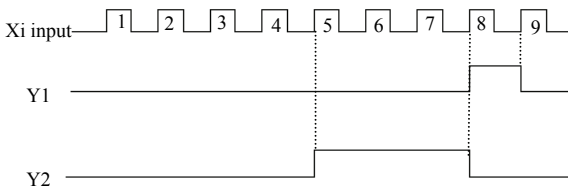

Fig. 7-21 set count value setting and specified count value setting

F08.29	Internal timer timing setting	Range:0.1~6000.0s	60.0s
---------------	--------------------------------------	--------------------------	--------------

This parameter sets timing time of inverter internal timer, timer is triggered by external triggering terminal (Xi terminal function no. is 61), the timer starts timing upon receiving external triggering signal. After reaching timing time, Yi terminal outputs a breadth of 0.5s valid pulse signal. When internal timer clearing terminal is valid (Xi terminal function is set as 60), internal timer is reset.

F08.30	terminal pulse encoder frequency rate	Range:0.01~10.00Hz	1.00Hz
---------------	--	---------------------------	---------------

This parameter defines main frequency regulation speed during terminal pulse encoder setting frequency (F01.00=9). Main frequency terminal encoder pulse input can only choose channel X1 and X2 combination; auxiliary frequency terminal encoder pulse input can only choose channel X3 and X4 combination.



Note

When 9 is selection in F01.00 and F01.03, X1~X4 can only be used as encoder frequency setting. Other terminal functions defined by F08.18~F08.21 are invalid.

F08.31	Reserved		
--------	----------	--	--

7.10 Switch output function parameter group: F9

F09.00	Open-collector output terminal Y1 output setting	Range:0~60	0
F09.01	Open-collector output terminal Y2 output setting	Range:0~60	0
F09.02	Open-collector output terminal Y3 output setting	Range:0~60	0
F09.03	Open-collector output terminal Y4 output setting	Range:0~60	0
F09.04	Programmable relay output setting	Range:0~60	22

Functions of the above parameters are used to select Y1 ~ Y4 and relay output terminals. Table 7-10 shows the functions of the above 4 terminals. One function can be selected repeatedly.

Open-collector (Yi) and high-speed pulse (DO) output share terminal Y4. Y4 terminal as the high-speed pulse function to be modified F00.22 thousands place to 1.

Table7-10 Output terminals function selection diagram

Setting	Function	Setting	Function
0	No output	31	Set count value reached
1	Frequency inverter running(RUN)	32	Designated count value reached
2	Frequency inverter Forward running	33	Shutdown time arrival of the running
3	Frequency inverter Reverse running	34	Time arrival of the running
4	Frequency inverter DC brake	35	Setup running time arrived
5	Frequency inverter Ready for operation(RDY)	36	Setup power-on time arrived
6	Shutdown command indicator	37	1 st pump variable frequency
7	Zero current state	38	1 st pump frequency
8	Over current state	39	2 nd pump variable frequency
9	Current 1 arrived	40	2 nd pump frequency
10	Current 2 arrived	41	Communication given
11	Frequency inverter Zero-frequency output	42	Reserved
12	Frequency arriving signal (FAR)	43	Reserved
13	Frequency level detection signal 1 (FDT1)	44	Reserved
14	Frequency level detection signal 2(FDT2)	45	Reserved
15	Output frequency arriving upper limit(FHL)	46	Reserved
16	Output frequency arriving lower limit(FLL)	47	Reserved
17	Frequency 1 arrived	48	Reserved

18	Frequency 2 arrived	49	Reserved
19	Frequency inverter overload pre- alarm signal(OL)	50	Reserved
20	Frequency inverter Low voltage lock-up signal(LU)	51	Reserved
21	External stopping command(EXT)	52	Reserved
22	Frequency inverter fault	53	Reserved
23	Frequency inverter warning	54	Reserved
24	Simple PLC operation running	55	Reserved
25	Completion of simple PLC operation	56	Reserved
26	Simple PLC cycle-running completed	57	Reserved
27	Simple PLC suspended	58	Reserved
28	Upper and lower limit of Wobble	59	Reserved
29	Setup length arrived	60	Reserved
30	Internal counter final value arrived	61	Reserved

The instructions of the function output terminals listed in table 7-10 are as below:

0: The terminal function is idle.

1:Frequency inverter is running(RUN).The Drive is in the running state, output the indicator signal.

2. Frequency inverter is forward running. The Drive is in the forward running state, output the indicator signal.

3. Frequency inverter is reversed running.The Drive is in reversed running state, output the indicator signal.

4.Frequency inverter is DC braking.The Drive is in DC braking state, output the indicator signal.

5. Frequency inverter is ready to run. This signal being valid means that the Drive bus voltage is normal, the Drive is running and forbidding the terminal is invalid, it can accept a start command.

6. Shutdown command indicator. When the shutdown command is valid, output the indicator signal.

7. Zero current is detected. When detected the output meet the zero current state, output the indicator signal. Please refer to the instruction of F09.12and F09.13parameters for details.

8. Over current is detected. When the output current meet the over current detection conditions, output the indicator signal. Please refer to the instruction of F09.14and F09.15 parameters for details.

9. Current 1 arrived. When the output current reaches the detection conditions to meet the current 1, output the indicator signal. Please refer to the instruction of F09.16and F09.17 parameters for details.

10. Current 2 arrived. When the output current reaches the detection

conditions to meet the current 2, output the indicator signal. Please refer to the instruction of F09.18 and F09.19 parameters for details.

11. Frequency inverter Zero frequency output. Please refer to the function instruction of F09.10 and F09.11.

12. Frequency arriving signal(FAR). Please refer to the function instruction of F09.05.

13. Frequency level detection signal 1(FTD1). Please refer to the function instruction of F09.06, F09.07.

14. Frequency level detection signal 2(FTD2). Please refer to the function instruction of F09.08, F09.09.

15. Output frequency reaches upper limit(FHL). When the running frequency reaches upper limit, output indicator signal.

16. Output frequency reaches lower limit(FHL). When the running frequency reaches lower limit, output indicator signal.

17. Frequency 1 arriving output. Please refer to the function instruction of F09.20, F09.21.

18. Frequency 2 arriving output. Please refer to the function instruction of F09.22, F09.23.

19. Frequency inverter overload pre-alarm signal. Frequency inverter output current exceeds F19.06 overload pre-alarm detection levels, and time is greater than F19.07 overload pre-alarm delay time, output the indicator signal.

20. Frequency inverter Low voltage lock-up signal(LU). When the frequency inverter is running, the DC bus voltage below the limit level, output indication signal.

21. External fault shutdown(EXT). When the frequency inverter appears external fault trip alarm (E-18), output indication signal.

22. Frequency inverter fault. When the frequency inverter detects fault, output indication signal.

23. Frequency inverter warning. When the frequency inverter detects alarm, output indication signal.

24. Simple PLC during operating. The simple PLC is enabled, and enter into operation state, output indication signal

25. Simple PLC stage operation completed. When the simple PLC stage operation is completed, output indication signal (single pulse signal, the width is 500ms).

26. Simple PLC ends after running a cycle. After the completion of a cycle of simple PLC, output indication signal (single pulse signal, the width is 500ms)

27. Simple PLC pause. When the simple PLC is running into the pause state,

output indication signal.

28. Wobble upper and lower limit. If the frequency fluctuation range calculated by center frequency exceeds the upper limit F01.11 or belows lower limit F01.12 after selecting the wobble function, it will output indication signal, as shown in Figure 7-22.

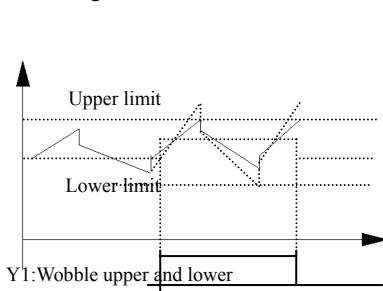

Fig.7-22 Wobble amplitude limit

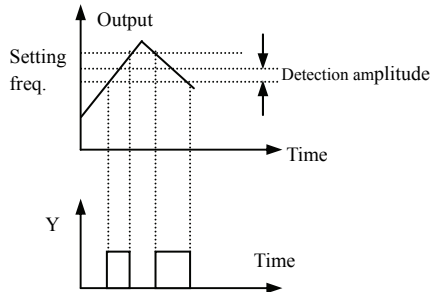

Fig.7-23 Freq. arrival signal output diagram

29. Setup length arrived. When detected the actual length exceeds a set value F13.08, output indication signal.

30. Internal counter final value arrived. Please refer to the function instruction of F08.27.

31. Internal counter specified value arrived. Please refer to the function instruction of F08.28.

32. Internal counter timing meter arrival. Please refer to the function instruction of F08.29.

33. Shutdown time arrival of the running. Frequency inverter runs longer than the setting time of F18.12, output indication signal.

34. Time arrival of the running. Frequency inverter runs longer than the setting time of F18.13, output indication signal.

35. Setup time arrived. Accumulated running time of the frequency inverter reaches the set accumulated running time (F18.10), output indication signal.

36. Setup power-on time arrived. Accumulated power on time of the frequency inverter reaches the set accumulated running time (F18.09), the output indication signal.

37: 1st pump variable frequency.

38: 1st pump frequency.

39: 2nd pump variable frequency.

40: 2nd pump frequency

When using Y1 ~ Y4 achieve two pumps constant pressure water supply, Y1 ~ Y4 functions are arranged in order of 37 to 40. Under constant pressure water supply

mode, the four parameters must all set to this value, the terminal functions can be achieved

41: Communication given.In this moment the output of Yi is controlled by communication, Please refer to the related communication protocol for details.

42~60: Reserved

F09.05	Detection amplitude of frequency arrival(FAR)	Range:0.00~50.00Hz	5.00Hz
---------------	--	---------------------------	---------------

This parameter is added in the definition of Table 7-10 on the 12th functions. As shown in Figure 7-23, when the inverter output frequency in the setting frequency of positive and negative detection width, output indication signal.

F09.06	FDT1(frequency level)level	Range:0.00Hz ~ upper limit frequency	10.00Hz
F09.07	FDT1 lag	Range:0.00~50.00Hz	1.00Hz
F09.08	FDT2(frequency level)level	Range:0.00Hz ~ upper limit frequency	10.00Hz
F09.09	FDT2 lag	Range:0.00~50.00Hz	1.00Hz

F09.06, F09.07 is in the definition of Table 7-10 on the 13th functions, F09.08,F09.08 is in the definition of Table 7-10 on the 14th functions, take an example of 13th functions: When the output frequency exceeds a certain setting frequency (FDT1 level), output indicator signal, until the output frequency drops below the certain frequency FDT1 frequency level (FDT1 level -FDT1 lag). As shown in Figure 7-24.

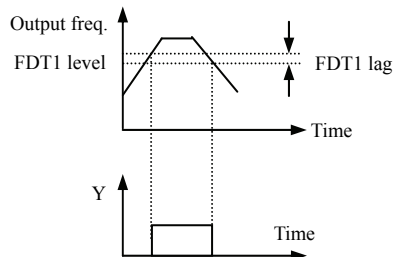

Fig.7-24 Freq. level detection diagram

F09.10	Zero-frequency signal detection value	Range:0.00Hz~upper limit frequency	0.00Hz
F09.11	Zero-frequency backlash	Range:0.00Hz~upper limit frequency	0.00Hz

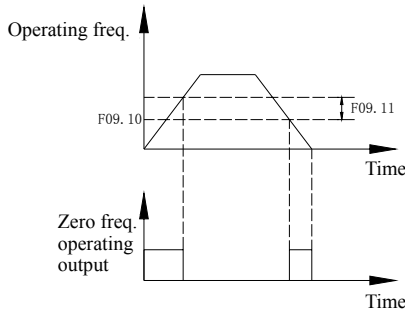

Fig.7-25 Zero-frequency signal detection

Parameter F09.10, F09.11 define the zero frequency output control function. When the output frequency is within the zero-frequency signal detection range, if Yi output function selects 11, the Yi output indication signal.

F09.12	Zero current detection amplitude	Range:0.0~50.0%	0.0%
F09.13	Zero current detection time	Range:0.00~60.00s	0.1s

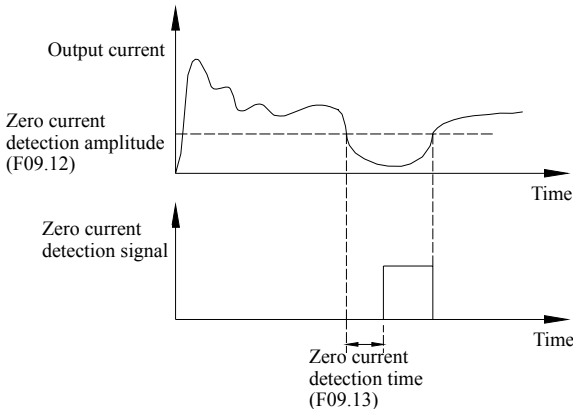

Fig.7-26 Zero current detection diagram

When the output current of the inverter is less than or equal to zero current detection level, and lasts longer than the zero current detection time, frequency inverter multifunction Yi output indication signal . Figure 7-26 is the schematic of zero current detection.

F09.14	Over-current detection value	Range:0.0~250.0%	160.0%
F09.15	Over-current detection time	Range:0.00~60.00s	0.00s

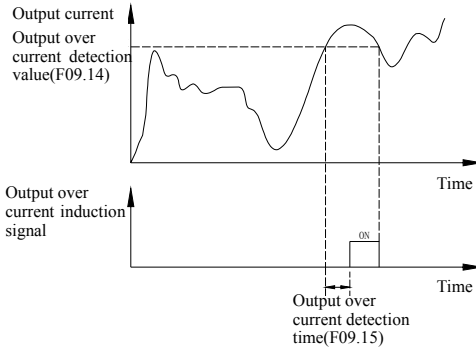

Fig.7-27 Output over-current detection diagram

When the output current of the inverter is greater than the over-current detection points, and lasted longer than the over-current detection time, frequency inverter multifunction Yi output indication signal , Figure 7-27 is the schematic of output over-current detection .

F09.16	Current 1 arriving the detection value	Range:0.0~250.0%	100.0%
F09.17	Current 1 width	Range:0.0~100.0%	0.0%
F09.18	Current 2 arriving the detection value	Range:0.0~250.0%	100.0%
F09.19	Current 2 width	Range:0.0~100.0%	0.0%

When the output current of frequency inverter is within the positive and negative detection width of setting current arrival, frequency inverter multifunction Yi output indication signal.

EN500 provides two current arrival and detection width parameters, table 7-28 is the function schematic diagram.

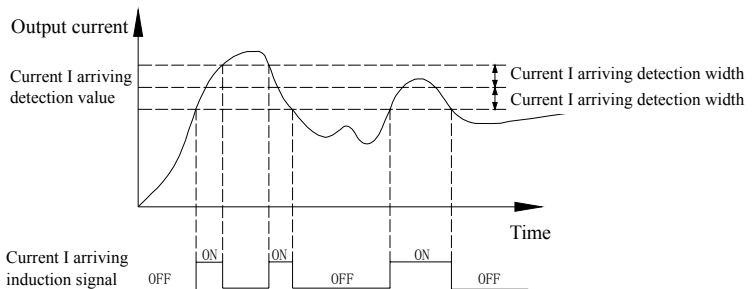

Fig.7-28 Current arriving detection diagram

F09.20	Frequency 1 arriving detection value	Range:0.00Hz ~ upper limit frequency	50.00Hz
F09.21	Frequency 1 arriving detection width	Range:0.00Hz ~ upper limit frequency	0.00Hz
F09.22	Frequency 2 arriving detection value	Range:0.00Hz ~ upper limit frequency	50.00Hz
F09.23	Frequency 2 arriving detection width	Range:0.00Hz ~ upper limit frequency	0.00Hz

When the output frequency of frequency inverter reaches detecting value of the positive and negative detecting width range, multifunctional Yi output indication signal.

EN500 provides two sets of frequency arrival detecting parameters, which have set frequency value and frequency detecting width respectively. Table 7-29 is the diagram of this function.

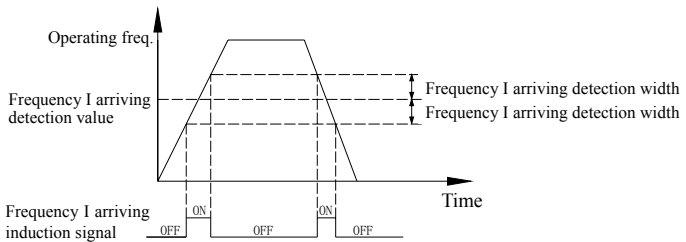

Fig.7-29 Frequency arriving detection diagram

F09.24	Positive and negative logic setting of output terminal	Range:0000~FFFF	0000
---------------	---	------------------------	-------------

This parameter defines the output logic of the standard output terminal Yi, relay RLY and expand output terminal EYi, relays ERIY1, ERLY2.

0: positive logic, output terminal and the common terminal close to the valid state, disconnect invalid state

1: reverse logic, output terminal and the common terminal close to the invalid state, disconnect valid state

F09.25	Y1 output closed delay time	Range:0.000~50.000s	0.000s
F09.26	Y1 output disconnected delay time	Range:0.000~50.000s	0.000s
F09.27	Y2 output closed delay time	Range:0.000~50.000s	0.000s
F09.28	Y2 output disconnected delay time	Range:0.000~50.000s	0.000s
F09.29	Y3 output closed delay time	Range:0.000~50.000s	0.000s

F09.30	Y3 output disconnected delay time	Range:0.000~50.000s	0.000s
F09.31	Y4 output closed delay time	Range:0.000~50.000s	0.000s
F09.32	Y4 output disconnected delay time	Range:0.000~50.000s	0.000s
F09.33	Relay output closed delay time	Range:0.000~50.000s	0.000s
F09.34	Relay output disconnected delay time	Range:0.000~50.000s	0.000s

Parameter F09.25 ~ F09.34 defines the corresponding delay time from connect or disconnect to frequency level of the multifunction output terminals. Table 7-30 is the schematic of multi-function output terminal operation.

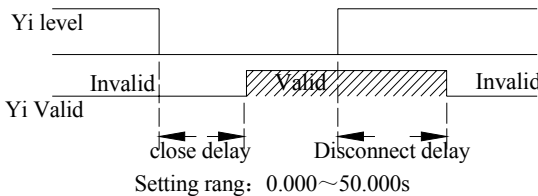

Fig.7-30 Multifunction output terminal action diagram

F09.35	Analog output (AO1) selecting	Range:0~25	0
F09.36	Analog output (AO2) selecting	Range:0~25	0
F09.37	DO function selecting (reuse with Y4)	Range:0~25	0

0:output frequency before slip compensation (0.00Hz~ upper limit frequency)

1:output frequency after slip compensation (0.00Hz~ upper limit frequency)

2: setup frequency (0.00Hz~ upper limit frequency)

3:master setup frequency (0.00Hz~ upper limit frequency)

4:auxiliary setup frequency (0.00Hz~ upper limit frequency)

5:current output 1 (0~2×rated current of frequency inverter)

6:current output 1 (0~3×rated current of frequency inverter)

7:output voltage (0~1.2×rated voltage of load motor)

8: bus voltage (0~1.5×Rated bus voltage)

9:motor speed (0~3 ×rated speed)

10:PID given (0.00~10.00V)

11:PID feedback (0.00~10.00V)

12:AI1 (0.00~10.00V or 4~20mA)

13:AI2 (-10.00~10.00V or 4~20mA)

14: communication given(AO output is controlled by communication, please refer to the related communication protocol for details.)

15~25: Reserved.



Note

- 1.Terminal AO1 and AO2 are optional output terminal of 0~10V or 4~20mA which can satisfy the variety needs of customer.
- 2.By disposing F00.21 analog output, output of terminal AO1 and AO2 can be 0~10V or 4~20mA to satisfy the variety needs of customer.
- 3.The unit's place of F00.22 is set to 1 when DO output pulse signal.

F09.38	Reserved		
--------	----------	--	--

F09.39	Analog output (AO1) filter time	Range:0.0~20.0s	0.0s
F09.40	Analog output (AO1) gain	Range:0.00~2.00	1.00
F09.41	Analog output (AO1) bias	Range:0.0~100.0%	0.0%

Parameter F09.39 defines the filter time of AO1 output, its reasonable setting can improve stability of analog output. But a higher setting will influence the rate of change, which can not reflect the instantaneous value of corresponding physical quantity.

If users want to change the display range or error correction table headers, you can achieve it by adjusting the output gain and bias of AO1.



Note

This function code will influence analog output during modify processes.

F09.42	Analog output (AO2) filter time	Range:0.0~20.0s	0.0s
F09.43	Analog output (AO2) gain	Range:0.00~2.00	1.00
F09.44	Analog output (AO2) bias	Range:0.0~100.0%	0.0%

Please refer to the function introduce of parameters F09.39~F09.41

F09.45	DO filter time	Range:0.0~20.0s	0.0s
F09.46	DO output gain	Range:0.00~2.00	1.00
F09.47	DO maximum pulse output frequency	Range:0.1~20.0KHz	10.0KHz

Please refer to the function introduce of parameters F09.39~F09.41.

Maximum pulse output frequency of terminal DO corresponds to maximum select value of F09.37. For example, F09.31=0, terminal DO's function is: output frequency before slip compensation, which means Maximum pulse output frequency corresponds to upper frequency.

F09.48	Reserved		
F09.49	Reserved		
F09.50	Reserved		

7.11 Simply PLC/multi-step speed function parameters group:F10

F10.00	Simply PLC operation setting	Range: LED units digit :0~3 LED tens digit:0~2 LED hundreds digit:0,1 LED thousands digit:0,1	0000
---------------	-------------------------------------	--	-------------

Setting by using the operation mode of PLC units digit, tens digit, hundreds digit and thousands digit, interrupt and then start mode, run-time units and power-down storage mode, the details as follows:

LED units digit: operating mode section

0: No action. PLC operating mode invalid.

1: Stop after single cycle. As shown in Fig. 7-31, the drive stops automatically after one cycle of operation and will start when receiving RUN command again.

2: Maintain the final value after single cycle of operation. As shown in Fig.7-32, the drive will maintain the operating frequency and direction of last stage after completing one cycle of operation.

3: Continuous operation. See Fig. 7-33, the drive will start next cycle of operation automatically after completing one cycle of operation until receiving STOP command.

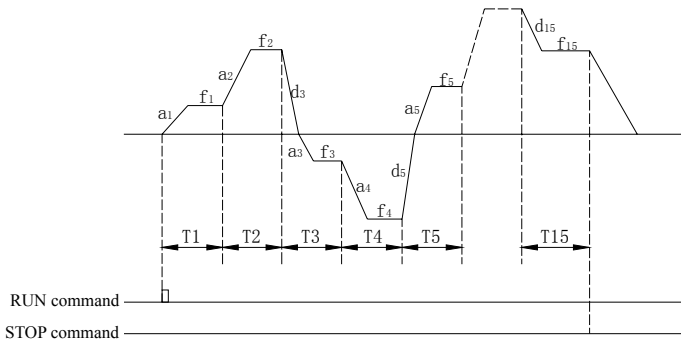

Fig.7-31 PLC stop after single cycle mode

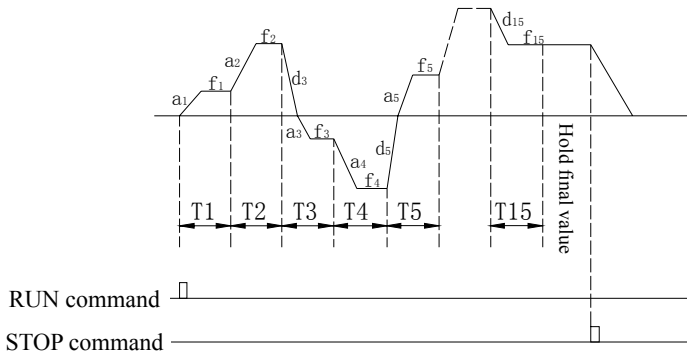

Fig.7-32 PLC maintain the final value after single cycle of operation

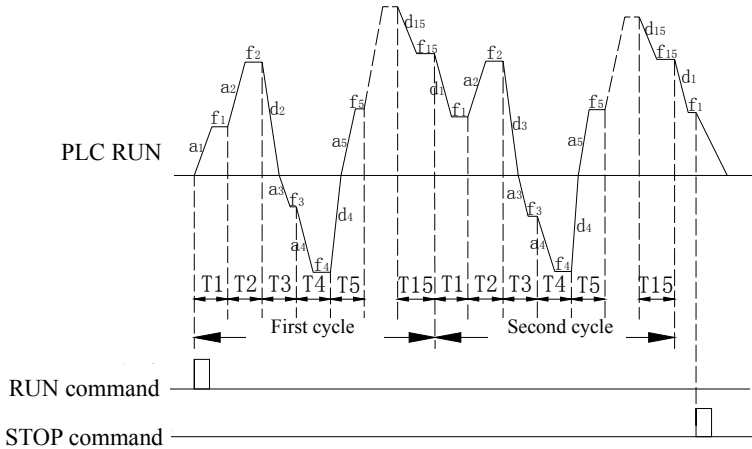

Fig.7-33 PLC continuous operation

a1~a15:are the Acc time in different stages

d1~d15:are the Dec time in different stages

f1~f15:are the frequency in different stages

Figure 7-31,7-32,7-33 are an example as 15 segments running.

LED tens digit: Restart after PLC operation pause

0: Operate from first section. If the drive stops during PLC operation due to receiving STOP command, fault or power failure, it will run from the first stage after restarting.

1: Continue from the stage where the drive stops. When the drive stops

during PLC operation due to receiving STOP command or fault, it will record the operating time and will continue from the stage where the drive stops after restart at the frequency defined for this stage, as shown in Fig. 7-34.

2: Continue to operate at the frequency when the drive stops. When the drive stops during PLC operation due to receiving STOP command or fault, it will record the operating time and the current frequency. It will continue running at the recorded frequency from the stage where it just stops upon restart, as shown in Fig. 7-35.

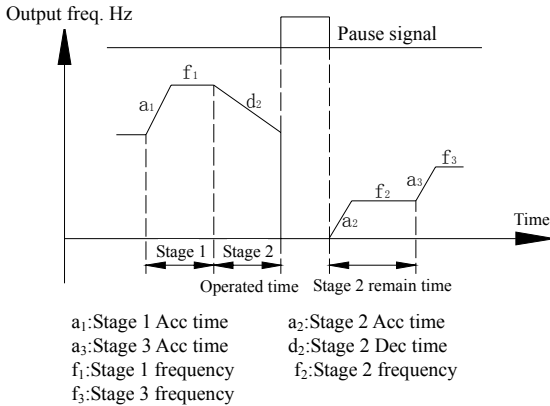

Fig.7-34 PLC start mode 1

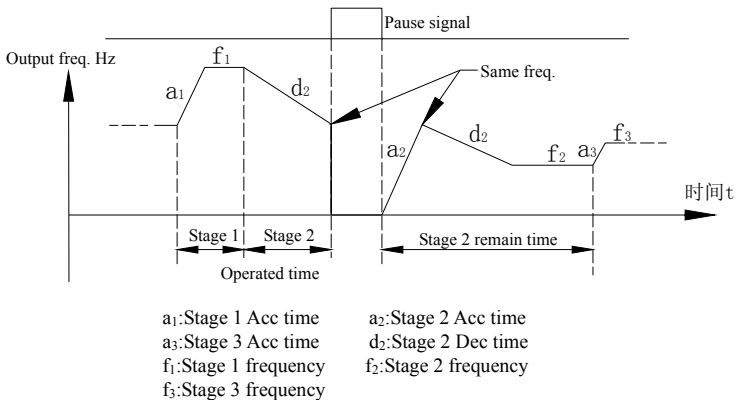

Fig.7-35 PLC Start mode 2

LED hundreds digit:PLC operating time unit.

0: Second

1: Minute

This unit is only valid for defining the PLC operating time. The unit of Acc/Dec time in PLC operation is determined by F01.19.



Note

1. The stage is ineffective if the time of this stage of PLC operation is set to 0.
2. You can use terminals to pause and disable PLC operation, and clear the memorized parameters. See the introductions to group F08 parameters.

LED thousands digit: Store the PLC status after power failure selection.

0: Not save. The drive does not save the PLC operating status after power failure and start operating in first stage after restart.

1: Save. Memorize the operating parameters of PLC operation after power failure, including the operating stage, operating frequency, and operating time. The drive will continue to operate in the mode defined by the Tens place.



Note

No matter Stop power-down storage or running power down store, you must set up thousand' place to one, the te's place to 1 or 2, otherwise power-down memory function is invalid.

F10.01	Stage 1 setting	Range:000~E22	000
F10.02	Stage 2 setting	Range:000~E22	000
F10.03	Stage 3 setting	Range:000~E22	000
F10.04	Stage 4 setting	Range:000~E22	000
F10.05	Stage 5 setting	Range:000~E22	000
F10.06	Stage 6 setting	Range:000~E22	000
F10.07	Stage 7 setting	Range:000~E22	000
F10.08	Stage 8 setting	Range:000~E22	000
F10.09	Stage 9 setting	Range:000~E22	000
F10.10	Stage 10 setting	Range:000~E22	000
F10.11	Stage 11 setting	Range:000~E22	000
F10.12	Stage 12 setting	Range:000~E22	000

F10.13	Stage 13 setting	Range:000~E22	000
F10.14	Stage 14 setting	Range:000~E22	000
F10.15	Stage 15 setting	Range:000~E22	000

F10.01~F10.15 are used to configure the operating frequency, direction and Acc/Dec time of each PLC operating stage, the details as follows:

LED units digit: Frequency setting

0: preset frequency i.i=1~15. Please refer to F10.31~F10.45 for definitions of preset frequencies.

1: The frequency is determined master and auxiliary synthesized frequency.

2: Reserved.

LED tens digit: Operating direction selection

0: Forward

1: Reverse

2: Determined by operating command.

LED hundreds digit: Acc/Dec time selection

0:Acc/Dec time 1

1:Acc/Dec time 2

2:Acc/Dec time 3

3:Acc/Dec time 4

4:Acc/Dec time 5

5:Acc/Dec time 6

6:Acc/Dec time 7

7:Acc/Dec time 8

8:Acc/Dec time 9

9:Acc/Dec time 10

A:Acc/Dec time 11

B:Acc/Dec time 12

C:Acc/Dec time 13

D:Acc/Dec time 14

E:Acc/Dec time15

Acc time 1~15 are defined by F01.17,F01.18,F04.16~F04.43

F10.16	Time of stage 1	Range:0.0~6000.0	10.0
F10.17	Time of stage 2	Range:0.0~6000.0	10.0
F10.18	Time of stage 3	Range:0.0~6000.0	10.0
F10.19	Time of stage 4	Range:0.0~6000.0	10.0

F10.20	Time of stage 5	Range:0.0~6000.0	10.0
F10.21	Time of stage 6	Range:0.0~6000.0	10.0
F10.22	Time of stage 7	Range:0.0~6000.0	10.0
F10.23	Time of stage 8	Range:0.0~6000.0	10.0
F10.24	Time of stage 9	Range:0.0~6000.0	10.0
F10.25	Time of stage 10	Range:0.0~6000.0	10.0
F10.26	Time of stage 11	Range:0.0~6000.0	10.0
F10.27	Time of stage 12	Range:0.0~6000.0	10.0
F10.28	Time of stage 13	Range:0.0~6000.0	10.0
F10.29	Time of stage 14	Range:0.0~6000.0	10.0
F10.30	Time of stage 15	Range:0.0~6000.0	10.0

Parameter F10.16 ~ F10.30 define each stage operating time of PLC from stage 1 to stage 15.



Note

Each stage operating time including Acc and Dec time.

F10.31	Preset frequency 1	Range: Low limit frequency~upper limit frequency	5.00Hz
F10.32	Preset frequency 2	Range: Low limit frequency~upper limit frequency	10.00Hz
F10.33	Preset frequency 3	Range: Low limit frequency~upper limit frequency	20.00Hz
F10.34	Preset frequency 4	Range: Low limit frequency~upper limit frequency	30.00Hz
F10.35	Preset frequency 5	Range: Low limit frequency~upper limit frequency	40.00Hz
F10.36	Preset frequency 6	Range: Low limit frequency~upper limit frequency	45.00Hz
F10.37	Preset frequency 7	Range: Low limit frequency~upper limit frequency	50.00Hz
F10.38	Preset frequency 8	Range: Low limit frequency~upper limit frequency	5.00Hz
F10.39	Preset frequency 9	Range: Low limit frequency~upper limit frequency	10.00Hz
F10.40	Preset frequency 10	Range: Low limit frequency~upper limit frequency	20.00Hz

F10.41	Preset frequency 11	Range: Low limit frequency~upper limit frequency	30.00Hz
F10.42	Preset frequency 12	Range: Low limit frequency~upper limit frequency	40.00Hz
F10.43	Preset frequency 13	Range: Low limit frequency~upper limit frequency	45.00Hz
F10.44	Preset frequency 14	Range: Low limit frequency~upper limit frequency	50.00Hz
F10.45	Preset frequency 15	Range: Low limit frequency~upper limit frequency	50.00Hz

These frequencies will be used in simple PLC operation and multi-step speed operation, refer to the introductions of F08 and group F10 parameters.

7.12 Closed-loop control parameters Group :F11

Analog feedback control system:

Pressure reference is input through the terminal AI1, and water pressure sensor send a 4-20mA to the terminal AI2 of inverter as a feedback signal,all of them make up of analog closed-loop control system via build-in PID adjuster ,as shown in Fig.7-36.

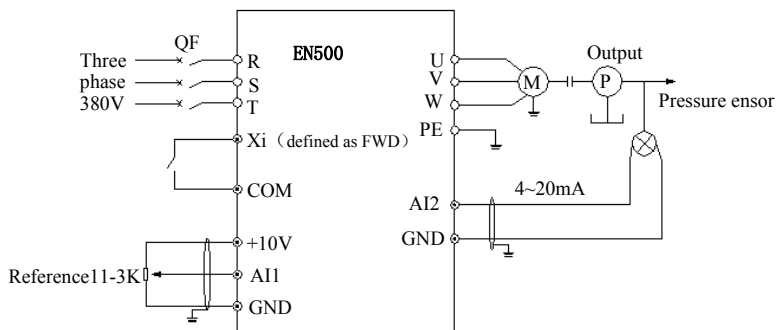

Fig.7-36 Analog feedback control system with internal PID function



The Pressure reference can also be input via the panel or other port which can choose by the parameter F11.01.

Operating principle of internal PID function of EN500 is shown in Fig.7-37 as below:

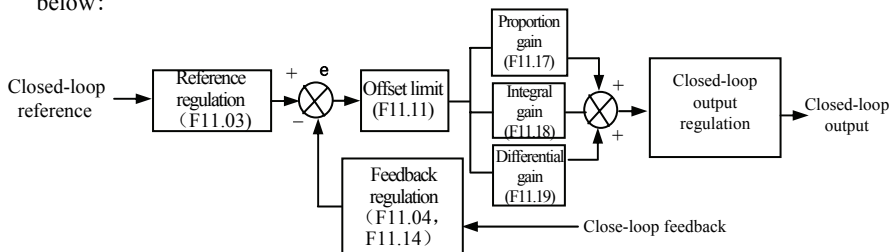

Fig.7-37 PID block control principle diagram

In above diagram ,the definition of closed-loop reference, feedback error limit and PI parameters are similar with the general PID adjuster, the relationship between reference and expected feedback is shown in Fig.7-38. The reference and feedback are converted and based on 10.00V.

In Fig.7-37,the real values of closed-loop reference and feedback can be regulated in Group F06 and F07,so that can reach a good performance.

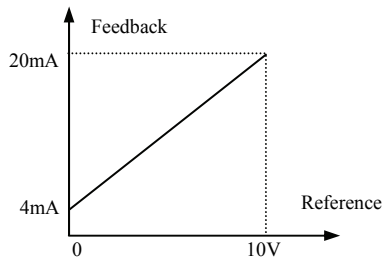

Fig.7-38 Reference and expected feedback

After the system control mode is confirmed ,follow the procedures below to set the closed-loop parameters:

- (1)Determine the closed-loop reference and feedback channel (F11.01, F11.02).
- (2)The relationship between the closed-loop reference and feedback should be defined for closed-loop control (the Group F6).
- (3) Set up the closed-loop frequency presetting function(F11.19, F11.20).
- (4) Adjust the proportion gain,integral gain,differential gain,sampling cycle and error limit(F11.07~F11.11).

F11.00	Closed-loop control function	Range: 0,1	0
---------------	-------------------------------------	-------------------	----------

0: PID closed-loop function disabled

1: PID closed-loop function enabled

F11.01	Reference channel choose	Range: 0~7	0
---------------	---------------------------------	-------------------	----------

0: Digital provision

1: AI1 analog 0-10V or 4-20mA provision

2: AI2 analog provision

3: EAI1 analog provision

4: EAI2 analog provision

5: Pulse provision

6: communication terminal provision (please refer to the chapter of

Modbus communication)

7: Keypad analog potentiometer provision (should order a panel with an analog potentiometer)



Note

Except for the above reference channels, it can also choose multi-closed-loop reference which determined by external terminal with high priority.

F11.02	Feedback channel choose	Range: 0~8	0
---------------	--------------------------------	-------------------	----------

- 0: AI1 analog provision
- 1: AI2 analog provision
- 2: EAI1 analog provision
- 3: EAI2 analog provision
- 4: AI1+AI2.
- 5: AI1-AI2.
- 6: Min {AI1, AI2}
- 7: Max {AI1, AI2}
- 8: Pulse provision

F11.03	Reference filter time	Range: 0.01~50.00s	0.20s
F11.04	Feedback filter time	Range: 0.01~50.00s	0.10s
F11.05	PID output filter time	Range: 0.00~50.00s	0.00s

The external reference signal and feedback signal usually carry some noise. those noise signal can be filtered by setting the time constant of filter in F11.03 and F11.04. The bigger the time constant, the better the immunity capability, but with a slow response. the shorter the time constant, the faster the response, but the immunity capability became weak.

The PID output filter time is the time of the filter for output frequency or torque, the bigger time, the slower the response output.

F11.06	Digital setting of reference	Range: 0.00~10.00V	1.00V
---------------	-------------------------------------	---------------------------	--------------

This function can realize digital setting via keypad.



Note

When the PID function is effective, if you want to change pressure reference by press \wedge \vee , you should set F18.14 as 1, otherwise you cannot adjust reference by press \wedge \vee in monitoring status.

F11.07	Proportion gain K	Range: 0.000~9.999	0.150
F11.08	Integral gain Ki	Range: 0.000~9.999	0.150
F11.09	Differential gain Kd	Range: 0.000~9.999	0.000
F11.10	Sampling cycle T	Range: 0.01~1.00s	0.10s

The bigger of the proportion gain of K_p , the faster the response, but oscillation may easily occur.

If only proportion gain K_p is used in regulation, the offset cannot be eliminated completely. To eliminate the offset, please use the integral gain K_i to form a PI control system. The bigger K_i is, the faster the response, but oscillation may easily occur if K_i is big enough.

The sampling cycle T refers to the sampling cycle of feedback value. The PI D regulator calculates once in each sampling cycle. The bigger the sampling cycle the slower the response.

F11.11	Offset limit	Range: 0.0~20.0%	2.0%
---------------	---------------------	-------------------------	-------------

It defines the max. Deviation of the output from the reference, as shown in Fig.7-39, the PID adjuster stops operation when the feedback value within this range. Setting this parameter correctly will improve the moderation of the accuracy and stability of the system.

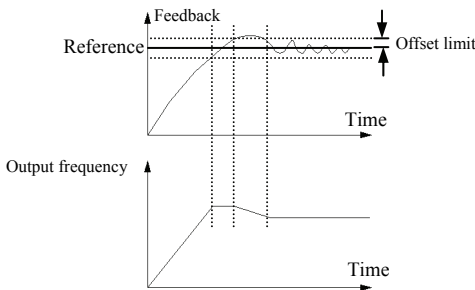

Fig.7-39 Offset limit



Note

Offset limit is the percentage that related to the value of reference.

F11.12	PID differential amplitude limit	Range: 0.00~100.00%	0.10%
---------------	---	----------------------------	--------------

In the PID regulator, the effect of differential is too sensitive too easy to cause system oscillation, therefore limit the effect of differential PID in a smaller range, F11.12 the parameter that used to set the output range of PID differential.

F11.13	Closed-loop regulation characteristic	Range: 0,1	0
---------------	--	-------------------	----------

0: positive. The speed of motor increase when the increase of the reference value

1: negative. The speed of motor decrease when the increase of the reference value.

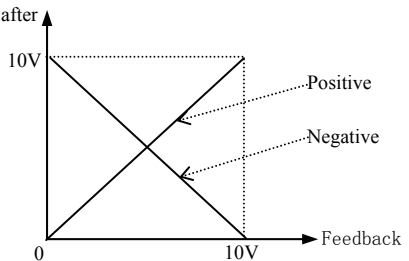
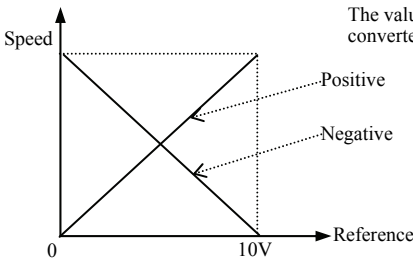

Fig.7-40 Close-loop characteristic

Fig.7-41 Feedback characteristic

F11.14	Feedback regulation characteristic	Range: 0,1	0
---------------	---	-------------------	----------

0: positive. The relationship between reference and feedback is positive

1: negative. The relationship between reference and feedback is negative

This parameter is used to change the feedback characteristic of the feedback signal. After input into inverter through the feedback channel, the feedback pressure will compare with the reference after regulated by the positive and negative characteristic regulation, as shown in Fig.7-41.

F11.15	PID adjusting upper limit frequency	Range: lower limit frequency ~ upper limit frequency	50.00Hz
F11.16	PID adjusting low limit frequency	Range: lower limit frequency ~ upper limit frequency	0.00Hz

User can set up the parameters F11.15 and F11.16 to define the output lower limit and upper limit frequency of the PID regulator .

F11.17	Integral adjusting selection	Range:0,1	0
---------------	-------------------------------------	------------------	----------

0: Stop integral regulating when the comparison value of the reference and feedback reaches the range of threshold for integral separation.

1: Keep integral regulating even though the comparison value of the reference and feedback reach the range of threshold integral separation.

Adjusting this parameter can avoid integral saturation and improve the response of the system.

F11.18	Integral separate PID threshold value	Range:0.0~100.0%	100.0%
---------------	--	-------------------------	---------------

PID integral separation function: there is no integral regulating just proportion regulating during closed-loop control when the comparison value that between reference and feedback is bigger than this threshold. When the comparison is

smaller than this threshold ,the integral regulating will be active,and can adjust the response speed of system by adjusting this parameter.

F11.19	Close-loop preset frequency	Range: lower limit frequency ~ upper limit frequency	0.00Hz
F11.20	Close-loop preset frequency keep time	Range:0.0~6000.0s	0.0s

This function can make the closed-loop adjuster into the stable status quickly.

When the closed-loop function start, the output frequency will ramp up to the preset closed-loop frequency(F11.19) within the Acc time,and keep running the time that set in F11.20 then start the closed-loop operation as shown is Fig.7-42.

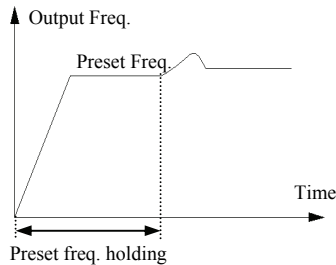

Fig.7-42 Preset closed-loop function



Note

Preset closed-loop frequency function is disabled when set F11.19 and F11.20 as 0.

F11.21	Closed-loop output mode choose	Range:0,1	0
---------------	---------------------------------------	------------------	----------

0: The inverter will runs with the low limit frequency when the closed-loop output value is negative.

1: The inverter will reverse running when the value of the closed-loop output is negative (be opposite of the initial direction).



Note

The comparison value can be display in the PID monitor parameter,it's positive when the reference bigger than feedback and negative when reference smaller than feedback value.

F11.22	Closed-loop reverse output upper limit frequency	Range:0.00Hz~upper limit frequency	50.00Hz
---------------	---	---	----------------

The PID regulator is a kind of bipolar adjustment. By setting F11.21 and F11.22,you can choose whether the inverter reverse run in some degree frequency or not when the comparison value that between reference and feedback is negative.

F11.23	Multisection close-loop provide 1	Range:0.00~10.00V	0.00V
F11.24	Multisection close-loop provide 2	Range:0.00~10.00V	0.00V
F11.25	Multisection close-loop provide 3	Range:0.00~10.00V	0.00V
F11.26	Multisection close-loop provide 4	Range:0.00~10.00V	0.00V
F11.27	Multisection close-loop provide 5	Range:0.00~10.00V	0.00V
F11.28	Multisection close-loop provide 6	Range:0.00~10.00V	0.00V
F11.29	Multisection close-loop provide 7	Range:0.00~10.00V	0.00V

Among the closed-loop reference channel, besides the 7 channels defined by F11.01,the closed-loop reference can also be defined in F11.23~F11.29. The priority of multi-closed-loop reference control is higher than the reference channels that defined by F11.01.

Multi-closed-loop reference 1~7 can be selected by external terminals which can refer to introductions to F08.18~F08.25 for detail functions.

7.13 Constant pressure water supply function parameters Group:F12

F12.00	Constant pressure water supply mode selection	Range: 0~4	0
---------------	--	-------------------	----------

0:no constant pressure water supply

1:select inverter to achieve one drive two mode

2:select extend board to achieve one drive two mode

3:select extend board to achieve one drive three mode

4:select extend board to achieve one drive four mode

This function can used to choose different kinds of constant pressure water supply mode,and you should choose an external constant pressure board to realize one-drive-three mode and one-drive-four-pump mode.



Note

1. The function of the group F11 will be effective automatically when the constant pressure supply function is effective.
2. Except for the related parameters that in group F11 and F12 for closed-loop,the function of Yi which enabled in F9 is needed if you want the inverter to work in one-drive-two-pump mode.

F12.01	Target pressure setup	Range: 0.000~long-distance pressure gage range	0.200Mpa
---------------	------------------------------	---	-----------------

This parameter defined the target pressure of the constant pressure supply system. The channels of the pressure reference and feedback are defined by F11.01 and F11.02.

F12.02	Sleep frequency minimum value	Range:0.00Hz~upper limit frequency	30.00Hz
F12.03	Awake pressure minimum value	Range:0.000~long-distance pressure gage range	0.150Mpa

The function of Sleep frequency threshold:To save energy and protect the motor,when the water feedback pressure within the offset limit(F11.11),and the operating frequency is under in the sleep frequency threshold(F12.02),after a sleep delay time(F12.04) ,the system will enter a sleep mode and the operating frequency will drop to 0.00Hz

To realize sleep function, F01.13 should be set to 3, and F12.04 bigger than 0.

Revival function:when the system is in the sleep mode,if the feedback water pressure keep less than F12.03(the revival pressure) a delay time(F12.05),the system will revival from the sleep mode.

F12.04	Sleep delay time	Range:0.0~6000.0s	0.0s
---------------	-------------------------	--------------------------	-------------

This parameter is the delay time to enter into sleep mode when the system meets sleep conditions. Within the sleep delay time, if the feedback pressure does not meet the sleep conditions, the system will not enter into sleep mode.

When F12.04=0, sleep function invalid.

F12.05	Awake delay time	Range:0.0~6000.0s	0.0s
---------------	-------------------------	--------------------------	-------------

When the constant pressure supply system under the sleep mode, if the feedback pressure of system less than F12.03 the revival pressure threshold, the system will revival and get out of sleep mode after the revival delay time.

F12.06	long-distance pressure gage range	Range: 0.001~9.999Mpa	1.000Mpa
---------------	--	------------------------------	-----------------

Setting this parameter can correspond the maximum feedback pressure with the analog feedback signal 10V or 20mA

F12.07	Allowed aviation of upper limit frequency and low limit frequency: when add or decrease pump	Range: 0.1~100.0%	1.0%
---------------	---	--------------------------	-------------

This parameter defines that the inverter begins to add or reduce pump when the output frequency falls in the allowed offset of the upper limit frequency or the lower limit frequency. The inverter begins to add pumps at upper limit frequency or reduce pumps at lower limit frequency when this parameter is set to be 0.0%.

F12.08	Pump switching estimate time	Range: 0.0~999.9s	5.0s
---------------	-------------------------------------	--------------------------	-------------

It's the judgment time of the system when the output frequency up to the upper limit frequency that need to add pump or the output frequency down to the lower limit frequency that need to reduce pump. After this time, the system will add pump or reduce pump to make the water pressure reach the requirement.

F12.09	Electromagnetism switch converter delay time	Range: 0.1~10.0s	0.5s
---------------	---	-------------------------	-------------

This parameter defines the action delay time of magnetic control conductor when it's switch from power source supply to variable or from variable frequency control to power source supply.

F12.10	Automatically switching time interval	Range: 0000~9999 minute	0
---------------	--	--------------------------------	----------

By setting this parameter can avoid the rust of motor when it's not work long time. The inverter will switch the work status of the working pump and static pump automatically and smartly under the switch internal.

The automatic switch function is disabled when set the parameter as 0000. The system will switch one times when every once restart of system as this parameter is 0001. If set the value of this parameter above 0002, the system will switch automatically according the switch internal.

F12.11	Reserved		
F12.12	Reserved		
F12.13	Reserved		
F12.14	Reserved		

7.14 Traverse Operating Parameters :Group F13

F13.00	Traverse Function enabling	Range: 0,1	0
---------------	-----------------------------------	-------------------	----------

0: disabled

1: enabled

F13.01	Raverse run mode	Range: LED units digit: 0,1 LED tens digit: 0,1 LED hundreds digit:0,1 LED thousands digit: 0,1	0000
---------------	-------------------------	--	-------------

LED units digit: Start mode

0: automatically enter. The drive will first operate at preset frequency of traverse operation for a certain time, and then enter traverse mode automatically.

1: terminal enter manually. If the multi-functional terminal (Xi is set to No.33 function) is enabled, the drive will enter traverse mode. If the terminal is disabled, the drive will end traverse operation and operate at the pre-traverse frequency .

LED tens digit: traverse operating amplitude

0: variable swing. Traverse operating amplitude AW changes with the central frequency and the change rate is defined by F13.02.

1: fixed swing. Traverse operating amplitude AW is determined by Max frequency and F13.02.

Note: the central frequency is set by main frequency

LED hundreds digit: traverse halt start mode selection

0: restart

1: start as previous halt record

LED thousands digit: saving the traverse operating parameters upon power outage. The traverse operating parameters can be saved when power outage occurs. The function is effective when the hundred's place is set at 1.

0: no reserve

1: reserve



Note

When variable amplitude happens, the input channel of central frequency is confirmed by F01.06. In the traverse frequency operation, adjust the central frequency, deceleration&acceleration time is controlled only by traverse frequency circle F13.04.

F13.02	Traverse frequency swing value	Range:0.0~50.0%	10.0%
---------------	---------------------------------------	------------------------	--------------

Variable amplitude: $AW = \text{central frequency} \times F13.02$

Fixed amplitude: $AW = \text{upper limit frequency} \times F13.02$



The traverse operating frequency is restricted by the upper and lower limit of frequency. Traverse operation will be abnormal if the frequency is set incorrectly.

F13.03	Jump frequency	Range:0.0~50.0%	2.0%
---------------	-----------------------	------------------------	-------------

As shown in Fig. 7-35, there is the jitter frequency if F13.03 is set to 0.

F13.04	Traverse cycle	Range:0.1~999.9s	10.0s
---------------	-----------------------	-------------------------	--------------

F13.04 defines a complete cycle of traverse operation including rising and falling processes.

F13.05	Triangular wave up time	Range:0.0~98.0%(traverse cycle)	50.0%
---------------	--------------------------------	--	--------------

Rising time of traverse operation = $F13.04 \times F13.05$.

Falling time of traverse operation = $F13.04 \times (1 - F13.05)$

Refer to Fig. 7-35.

F13.06	Traverse preset frequency	Range:0.00~400.00Hz	0.00Hz
---------------	----------------------------------	----------------------------	---------------

F13.06 is used to define the drive's operating frequency before entering traverse mode.

F13.07	Traverse preset frequency waiting time	Range:0.0~6000.0s	0.0s
---------------	---	--------------------------	-------------

If auto-start mode is selected, F13.07 is used to define the time when the drive operates at pre-traverse frequency. If manual start mode is selected, F13.07 is disabled.

Refer to Fig. 7-43.

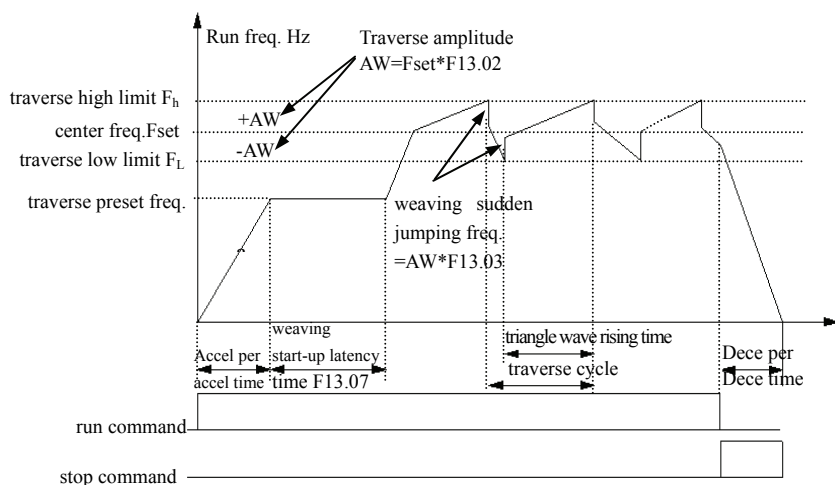

Fig 7-43 Traverse operation

F13.08	Setup length	Range:0~65535m	0m
F13.09	Pulse No. of axis per circle	Range:1~10000	1
F13.10	Axis perimeter	Range:0.01~100.00cm	10.00cm
F13.11	Reserved		
F13.12	Length correction coefficient	Range:0.001~1.000	1.000

Preset length, Actual length and Number of pulses per revolution are mainly used on fixed-length control. The length is determined by the Input pulse signal X_i ($i=1-8$), set the X_i function code to 62 and length signal output.

Physical length = (number of pulses \times F13.10 \times F13.12) / F13.09, when

physical length (F00.02 = 39) exceed the setting length (F13.08), we can get the "length finished" signal though Y_i and relay output.



Note

When F00.02=39, physical length can be monitored by C-02 in this running mode.

F13.13	After length arrival: record length manage	Range: 0,1	1
--------	--	------------	---

0: automatically reset

When the count length arrived, counter reset pulse, and the arrival of the next,

continue to count.

1: no change

When the count length arrived , the counter will keep the numerical value.

F13.14	When stop: record length manage	Range: 0,1	1
---------------	--	-------------------	----------

0: automatically reset

The length of the current record is automatically cleared at stop.

1: no change

The current record length remains unchanged at stop.

7.15 Velocity Control Parameter Group:F14

F14.00	Velocity ring proportional gain	Range:0.010~6.000	0.700
F14.01	Velocity ring integral time constant	Range:0.010~9.999	0.360

F14.00 and F14.01 are used for setting proportional gain and Integration time of speed regulator, to adjust Speed response characteristics of vector control .

F14.02	Torque limit value	Range:50.0~200.0%	150.0%
---------------	---------------------------	--------------------------	---------------

F14.02(Torque limit) is used for limiting the Torque current of speed regulator.

Torque limit 50.0~200.0 is the inverter rating current; Torque limit=100% , that is setting limitation of Torque current as the rating current of inverter .

F14.03	Motor stability coefficient	Range:10~300	100
---------------	------------------------------------	---------------------	------------

When the oscillating or instability happen to the motors on the inverter, set F14.03 parameter larger to clear oscillating.

F14.04	Suppression vibration low limit frequency	Range:0.00~2.00Hz	0.50Hz
F14.05	Suppression vibration upper limit frequency	Range:8.50~35.00Hz	12.50Hz
F14.06	Suppression vibration compensation gain	Range:100.0~130.0%	100.0%

In many application environment, the current oscillations may happen to AC motors in no-load run model. The larger power of AC motors, the more series of the situation. And AC motors will run in a stable Model, it will lead to over-current to frequency inverter. Then, setting F14.04 and F14.05 (the upper and lower limit of frequency) to suppress the current oscillation.

When F14.06=100%, the compensation amount will be 0. So be careful this parameter is not very big, or over-current will happen at start.

F14.07 ~ F14.25	Reserved		
--------------------------------	-----------------	--	--

7.16 Asynchronous Motor Parameter Group:F15

F15.00	Asynchronous motor rated power	Range:0.1~999.9KW	Base on motor type
F15.01	Asynchronous motor rated voltage	Range:1~690V	Base on motor type
F15.02	Asynchronous motor rated current	Range:0.1~999.9A	Base on motor type
F15.03	Asynchronous motor rated frequency	Range:0.00~400.00Hz	Base on motor type
F15.04	Asynchronous motor rated speed	Range:0~60000r/min	Base on motor type
F15.05	Asynchronous motor poles No.	Range:1~7	2

In order to make the inverter run in a safety way, please refer to the date on the nameplate of the motors.



F15.06	Asynchronous motor stator resistance	Range:0.0000~6.5535Ω	Base on motor type
F15.07	Asynchronous motor rotor resistance	Range:0.0000~6.5535Ω	Base on motor type
F15.08	Asynchronous motor leakage inductance	Range:0.00~655.35mH	Base on motor type
F15.09	Asynchronous motor mutual inductance	Range:0.00~655.35 mH	Base on motor type
F15.10	Asynchronous motor no load current	Range:0.01~655.35A	Base on motor type

When changing the parameter of the nameplate every time, inverter will set F15.06~F15.10 as the default motor parameter.

F15.11	Asynchronous motor parameter auto-tune	Range:0~3	0
--------	--	-----------	---

0: no action.

1: static auto-tune.

When motors cannot load disengage with load or the process is complex, then choosing quiet self-adjustment .Values on the motor's nameplate must be input correctly before starting auto-tuning.(F15.00-F15.05, setting F15.11 =1 , press  ,return to monitoring mode, and then press  to start auto-tuning, the keyboard will show “tune”.

After self-adjustment, inverter will auto-log out, it will save the result of stator resistance, rotor resistance and Stator leakage inductance into F15.06~F15.08.

No-load current and common reactance of motor cannot be auto-tune out. user can refer to the Motor factory data or the data on the test report; we do not need to Input it if there is no data accordingly, adopted the Default function. But it may



cause the control performance if the AC motors.

During the process of auto-tuning, when fault comes, press , finish auto-tuning processing.

2: Rotating auto-tuning.

If the load of motors is smaller than 30% of the rated power or the load is some small inertia load. We can choose to use Rotating auto-tuning function.

In order to make sure the parameter after auto-tuning is exactly please remove the load and let the motor is static or unloaded. But please try to get rid of load, make sure that AC motor is in static or unloaded state, or the parameter may not exactly after auto-tuning.

Before auto-tuning, make sure the parameter(F15.00-F15.05)inputted motor nameplate is correct, set F15.11=2, press , then press  back into monitor mode, auto-tuning will begin, the “tune” will show on the keyboard. After auto-tuning is finished, inverter will exit this mode automatic, saving the result of stator resistance, rotor resistance, motor leakage inductance, motor common reactance and unloaded current into F15.06-F15.10 for auto-tuning.

During the whole process of auto-tuning, if the fault happens, users can press to stop auto-tuning.

3:Reserved.

7.17 Reserved Parameter Group 1: F16

F16.00 ~ F16.29	Reserved		
-------------------------------------	-----------------	--	--

7.18 Reserved Parameter Group 2: F17

F17.00 ~ F17.20	Reserved		
-------------------------------------	-----------------	--	--

7.19 Enhance Control Parameter Group:F18

F18.00	Operation panel control frequency binding	Range:0~15	0
---------------	--	-------------------	----------

F18.00 definite the combination of operation command channel on the operation panel and many frequency for a given channel, to achieve synchronous switching.

0:no binding

1:operation keyboard digital setup

2:A11 analog setup

3:A12 analog setup

4:terminal UP/DOWN adjusting setup

5:communication provide(Modbus and external bus use the same main frequency storage)

6:EAI1 analog setup(extension valid)

7:EAI2 analog setup(extension valid)

8:high speed pulse setup(X8 terminal need choose the relative function)

9:terminal pulse width setup(X8 terminal need choose the relative function)

10:terminal encoder provide(decide by X1, X2)

11:keyboard analog potentiometer setup(analog potentiometer keyboard accessories in option)

12~15:Reserved.

Different running command channel can bind different frequency setting channel .After the Binding function is set, the binding frequency setting channel is the highest priority, but it only sets as main frequency binding setting.

F18.01	Terminal control frequency binding	Range:0~15	0
---------------	---	-------------------	----------

Refer to F18.00 description.

F18.02	Communication control frequency binding	Range:0~15	0
---------------	--	-------------------	----------

Refer to F18.00 description.

F18.03	Digital frequency integral function selection	Range: LED units digit:0,1 LED tens digit:0,1	00
---------------	--	--	-----------

LED units digit: keyboard UP/DW Integration control

0:integral function

1:no integral function

LED tens digit: terminal UP/DW integral control

0:integral function

1:no integral function

This function should work in with multi-function terminals 16,17.

F18.04	Keyboard UP/DW integral rate	Range:0.01~50.00Hz	0.10Hz
---------------	-------------------------------------	---------------------------	---------------

When the keyboard UP/DW Integration is enabled , if keep adjusting the frequency in the same direction, the Integration effect will happen , Integration Rate is determined by F18.04.

This function is available for some applications that need adjusting the frequency with quick response.

F18.05	Keyboard no integral single step's size setup	Range:0.01~10.00Hz	0.01Hz
---------------	--	---------------------------	---------------

When the keyboard UP/DW Integration is disabled, adjusting frequency to which the Single-step length is fixed to F18.05.

F18.06	Terminal UP/DW integral rate	Range:0.01~50.00Hz	0.20Hz
F18.07	Terminal no integral single step's size setup	Range:0.01~10.00Hz	0.10Hz

For the function of F18.06, F18.07, please refer to F18.04 and F18.05.

F18.08	Droop control decline frequency	Range:0.00~10.00Hz	0.00Hz
---------------	--	---------------------------	---------------

When several drives drive one load, the function can make the drives share the load equally. When the load of one drive is heavier, this drive will reduce its output frequency to shed part of the load according to the settings of F18.08. You can increase the setting gradually when testing.

F18.09	Setup accumulate power on time	Range:0~65535h	0
F18.10	Setup accumulate run time	Range:0~65535h	0

When Accumulative running time reach to the time of (F18.10), Output the indication signal, please refer to the description of F09.00~F09.03 function . F18.09 shows the Accumulative running time From Ex factory till now.



Note

Both power-on time and Accumulative running time can be checked though Monitoring parameters C.

F18.11	Setup run function enable	Range:0,1	0
---------------	----------------------------------	------------------	----------

0:invalid

1:valid

F18.12	Setup run stop time	Range:0.1~6500.0Min	2.0Min
---------------	----------------------------	----------------------------	---------------

When the setting F18.11 enabled , inverter start timing , until setting run down time , inverter stop automatic, multi-function Yi output pilot signal(if setting Yi function as 33).



Note

This inverter time from 0 every time , user can monitor the operation time though 0 group.

F18.13	Currently run arrival time	Range:0.0~6500.0Min	1.0Min
---------------	-----------------------------------	----------------------------	---------------

When the starting time reach to this time, the multi- function Digital Yi will indicate the signal for Timing operation time at this time(Yi function =34).

F18.14	Keyboard UP/DW selection under monitor mode	Range:0~6	0
---------------	--	------------------	----------

0: keyboard frequency provide value adjusting

1: PID digital provide value adjusting

2~6: Reserved.

When F18.14=1,under the keyboard Monitor Mode, UP/DW only can be used to adjust the digital figures from closed loop PID. When this parameter is 0, keyboard UP/DW is used to adjust frequency, it will not effect from Monitor Mode.

F18.15 ~ F18.24	Reserved		
-------------------------------------	-----------------	--	--

7.20 Protective Relevant Function Parameter Group: F19

F19.00	Power off restart waiting time	Range:0.0~20.0s	0.0s
---------------	---------------------------------------	------------------------	-------------

When the power down , then power-on , whether this inverter will start and the waiting time before start automatic.

When F19.00=0.0s,after the power down then power-on , inverter will not start automatic .F19.00≠0.0s,after the power down then power-on, if all is ready, inverter will run automatic after getting the time of F19.00 defined.



Note

Power down , then power-on need the running state of before the power is down, when power-on again, there is fault and the Signal stand still, and there is no any other factors that will influence start normally, only this we can restart inverter after power down.

F19.01	Fault self-recovery times	Range:0~10	0
F19.02	Fault self-recovery interval time	Range:0.5~20.0s	5.0s

When the inverter is running , because of fluctuation of load, faults may happen in some case and it will top to output. In order not to stop the operation of equipment , choosing the recovery functions No alarm, stop in stopping mode. Inverter will recovery to run with speed-checking restart style, within the setting time, if inverter can not ran, then fault protection will begin, stop running. No alarm, when the self recovery times of fault is set to 0, self recovery function stop.



- 1. When using fault self recovery function, and make sure the equipment is permitted and inverter do not enter fault.**
- 2. Self recovery function have the effect on power-on terminal Protection, clock fault. overload and over-heated,output short-circuit, short circuit to ground ,and the lack-voltage when running of fault Protection is disabled.**
- 3. When F19.00≠0,open stop and restart function .We can start this equipment without operators, so be careful to use this function.**

F19.03	Motor overload protection action selection	Range:0~2	2
---------------	---	------------------	----------

When the AC motors is overloaded , this mode of Protection will happen.

0: Alarm, continue operation happens with only warning, no motor overload Protection characteristic(used cautiously, at this time , inverter has nothing to

do with load motor for overload Protection ;

1: Alarm, Stop according to the stop mode

2: Fault, Free stop. When it is overloaded , the output of inverter is block , this AC motor free stop .

F19.04	Motor overload protection coefficient	Range:20.0~120.0%	100.0%
---------------	--	--------------------------	---------------

In order to apply effective overload protection to different kinds of motors, the Max output current of the drive should be adjusted as shown in Fig. 7-44.

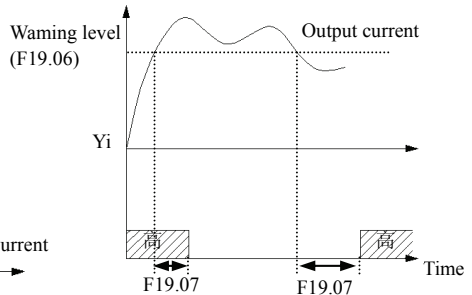
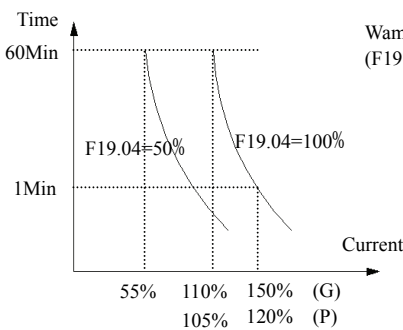

Fig.7-44 Electronic thermal relay protection Fig. 7-45 Overload alarm

This adjustable value can base on the user’s setting. In the same condition, if the AC motor is overloaded and need the fast protection, then decrease F19.04 , or else increase.

F19.05	Inverter overload pre-alarm detection selection	Range:0,1	0
---------------	--	------------------	----------

0 : detection all the time. during the working process of inverter , it still work after detecting overload situation.

1 :enable only constant speed detection. Only the inverter work in a constant speed mode, it still work after detecting overload situation .

F19.06	Inverter overload pre-alarm detection level	Range:20~180%	130%
F19.07	Inverter overload pre-alarm delay time	Range:0.0~20.0s	5.0s

If output current higher parameter F19.06,the set electrical level will go though delay time of F19.07,open collector will output enabled signal (please refer to fig7-45 and parameter list F09.00~F09.03).

F19.08	Motor underload alarm detection level	Range:0.0~120.0%	50.0%
F19.09	Motor underload alarm detection time	Range:0.1~60.0s	2.0s

The output current Inverter will lower than Underload alarm detection level F19.08 (definite the value, comparing to motor rating current) , and the last time will over motor underload alarm detection level time F19.09,then Yi will output Underload alarm Signal .

F19.10	Motor underload alarm detection action	Range: LED units digit: 0~2 LED tens digit:0~2	00
---------------	---	---	-----------

LED units digit: detection selection.

0 : No detection.

1 :The operation has been detected all the time. This detection is enabled during the running process of inverter.

2 :Detect in constant speed mode only. This detection is enabled during the constant speed mode only.

LED tens digit: action selection.

0 : when it's in alarm,continue operation, inverter will only warn when detecting motor is underload alarm

1 :Alarm, Stop according to the stop mode

2 :Fault, Free stop .The inverter will detect motor is in underload alarm, and it will lock PWM output, the motor will stop with free rotation.

F19.11	Input&output phase loss,short circuit detection action	Range: LED units digit:0,1 LED tens digit:0,1 LED hundreds digit: 0,1 LED thousands digit:0,1	1111
---------------	---	--	-------------

LED units digit: input phase failure protect

0 : No detection.

1 :Fault, Free stop .When inverter detect that the input is lacked one phase, alarm in input lacked, alarm, free stop.

LED tens digit: output phase failure protection

0 : No detection.

1:Fault, Free stop .When inverter detect that the output is lacked one phase, alarm in input lacked, then Free stop.

LED hundreds digit: power-on will detect Short circuit protection.

0 : No detection.

1 :Fault, Free stop .When inverter is power-on, the output to earth is short-circuit. At this time, power-on protection to earth short-circuited is alarmed , then Free stop .

LED thousands digit: The detection to earth Short circuit protection in the running mode.

0 : No detection .

1: Fault, Free stop.When inverter is power-on, the output to earth is

short-circuit during the running process. At this time, power-on protection to earth short-circuited is alarm ,then Free stop.

F19.12	Overvoltage stall selection	Range:0,1	1
---------------	------------------------------------	------------------	----------

0 :Disabled.

1 :Enabled

F19.13	Overvoltage stall protection voltage	Range:120~150%	125%
---------------	---	-----------------------	-------------

During deceleration, the motor's decelerate rate may be lower than that of drive's output frequency due to the load inertia. At this time, the motor will feed the energy back to the drive, resulting in the voltage rise on the drive's DC bus. If no measures taken, the drive will trip due to over voltage.

During the deceleration, the drive detects the bus voltage and compares it with the over voltage point at stall defined by F19.13. If the bus voltage exceeds the stall over-voltage point, the drive will stop reducing its output frequency. When the bus voltage become lower than the point, the deceleration continues, as shown in Fig. 7-46.

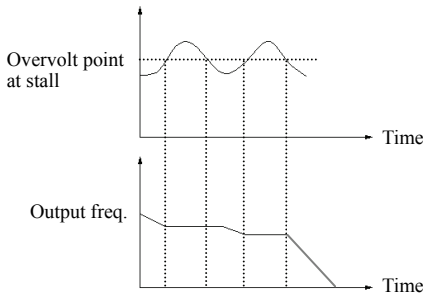

Fig. 7-46 Over-voltage at stall

F19.14	Automatic current limit level	Range:110~200%	150%
F19.15	Frequency decline rate of automatic current limit	Range:0.00~99.99Hz/s	10.00Hz/s
F19.16	Automatic current limit action selection	Range:0,1	0

0 :Constant speed disabled.

1 :Constant speed enabled.

Auto current limiting function is used to limit the load current smaller than the value defined by F19.14 in real time. Therefore the drive will not trip due to surge

over-current. This function is especially useful for the applications with big load inertia or big change of load.

F19.14 defines the threshold of auto current limiting. It is a percentage of the drive's rated current.

F19.15 defines the decrease rate of output frequency when the drive is in auto current limiting status.

If F19.15 is set too small, overload fault may occur. If it is set too big, the frequency will change too sharply and therefore, the drive may be in generating status for long time, which may result in overvoltage protection.

Auto current limiting function is always active in Acc or Dec process. Whether the function is active in constant speed operating process is decided by F19.16.

F19.16=0 Auto current limiting function is disabled in constant speed operating process;

F19.16=1 Auto current limiting function is enabled in constant speed operating process;

In auto current limiting process, the drive's output frequency may change; therefore, it is recommended not to enable the function when the drive's output frequency is required stable.

F19.17	Reserved		
---------------	-----------------	--	--

F19.18	Motor run section selection when instant power off	Range:0,1	0
---------------	---	------------------	----------

0 :disabled

1 :enabled

F19.19	Frequency droop rate when instant power off	Range:0.00~99.99Hz/s	10.00Hz/s
F19.20	Voltage rebound estimate time when instant power off	Range:0.00~10.00s	0.10s
F19.21	Action estimate voltage when instant power off	Range:60~100%	80%
F19.22	Allowed the longest off time when instant power off	Range:0.30~5.00s	2.00s

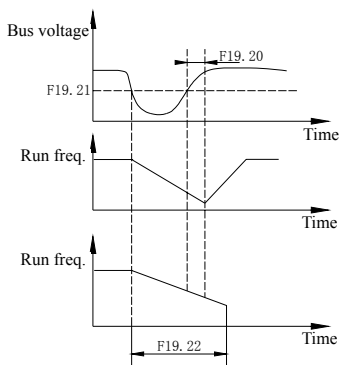

Fig 7-47 AC drive action diagram upon instantaneous power failure

Upon instantaneous power failure or sudden voltage dip, the DC bus voltage of the AC drive reduces. This function enables the AC drive to compensate the DC bus voltage reduction with the load feedback energy by reducing the output frequency so as to keep the AC drive running continuously.

If F19.18 = 1, upon instantaneous power failure or sudden voltage dip, the AC drive decelerates. Once the bus voltage resumes to normal, the AC drive accelerates to the set frequency. If the bus voltage remains normal for the time exceeding the value set in F19.20, it is considered that the bus voltage resumes to normal.

When instantaneous power failure happens, if the time is exceed the time of F19.22 definite, inverter No alarm, stop in stopping mode Free stop.

F19.23	Terminal external device fault action selection	Range: 0~2	2
---------------	--	-------------------	----------

0: Alarm, continue operation. When inverter checked that Terminal of the external is no alarm, stop in stopping mode enabled, it will alarm, then run continue. Under this mode, the inverter will do nothing with Terminal of the external in No alarm, stop in stopping mode, so please cautiously use.

1: Alarm, Stop according to the stop mode. When Inverter detect terminal outside fault is enabled, alarm, and then press Stop in stopping mode.

2: Fault, Free stop. When inverter detect terminal external fault is enabled, alarm for external equipment fault, and free stop.

F19.24	Power on terminal protection selection	Range: 0,1	1
---------------	---	-------------------	----------

0 :disabled.

1 :enabled.

When setting power down and then restart function is enabled, this function is disabled. When the running command channel is terminal command, and when power-on and detection run the command is enabled, it will get terminal protection with faults, this function only is enabled for terminal FWD/REV function.

F19.25	Provide lost detection value	Range:0~100%	0%
F19.26	Provide lost detection time	Range:0.0~20.0s	0.5s

When setting PID is lower than F19.25 definition continuous(setting the Max. as base), and the constant time is over than the time that F19.26 definition detected, then PID setting will lost, inverter will run base on F19.31 Units place set.PID loss detection show on fig 7-48.

F19.27	Feedback lost detection value	Range:0~100%	12%
F19.28	Feedback lost detection time	Range:0.0~20.0s	0.5s

When the feedback value of PID is lower than F19.27 definite(setting the input as base, and the constant time is over than the time that F19.28 definition detected, then PID setting will lost.

Inverter will run base on F19.31 Tens place set.PID loss detection show on fig 7-48.

F19.29	Deviation magnitude abnormal detection value	Range:0~100%	50%
F19.30	Deviation magnitude abnormal detection time	Range:0.0~20.0s	0.5s

When the Error amount of PID is higher than F19.29 definite(setting the input as base,and the constant time is over than the time that F19.30 definition detected,then PID setting will lost. inverter will run base on F19.31 hundred's place set.PID loss detection show on fig 7-48.

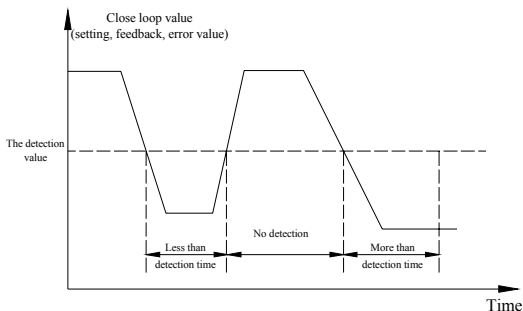

Fig. 7-48 Closed loop detection timing diagram

F19.31	Protection action selection 1	Range: LED units digit:0~3 LED tens digit:0~3 LED hundreds digit:0~3	000
---------------	--------------------------------------	---	------------

This parameter definite the Internal PID control the action selection of the setting loss and the fault Error amount. When it's set as 0 OR 1, inverter will has no response. And with no protection selection , users should set this parameter basing on the actual applications.

LED units digit: setting PID lost motion detection.

0 : no detection .

1 : Alarm,continue operation

2 :Alarm, Stop according to the stop mode

3 :Fault, Free stop .

LED tens digit: PID feedback for lost motion detection.

0 : no detection.

1 : Alarm,continue operation.

2 : Alarm, Stop according to the stop mode .

3 : Fault, Free stop .

LED hundreds digit: The amount of error fault for PID detection operation

0 : no detection .

1 : Alarm,continue operation

2 : Alarm, Stop according to the stop mode

3 : Fault, Free stop .

F19.32	Protection action selection 2	Range: LED units digit: 0~2 LED tens digit:0~2 LED hundreds digit: 0~2 LED thousands digit:0,1	1200
---------------	--------------------------------------	---	-------------

This parameter definite the communication fault , E²PROM fault , Contactor fault and lack-voltage when it's in No alarm, stop in stopping mode for the action selection of inverter. When it's set as 0, during the fault situation, inverter will only alarm. And with no protection selection, users should set this parameter basing on the actual applications.

LED units digit: communication fault action , including communication replay and fault.

0 : Alarm, continue operation

1 :Alarm, Stop according to the stop mode

2 :Fault, free stop .

LED tens digit: E²PROM fault action selection.

0 : Alarm, continue operation

1 :Alarm, stop according to the stop mode

2 :Fault, free stop .

LED hundreds digit: Contactor fault action selection.

0 : Alarm, continue operation

1 :Alarm, stop according to the stop mode

2 :Fault, free stop .

LED thousands digit: lack-Voltage fault display action selection.

0 : no detection.

1 :Fault, free stop .

F19.33	Reserved		
F19.34	Reserved		

F19.35	Fault indication and clock during the period of recovery	Range: LED units digit: 0,1 LED tens digit: 0,1	00
---------------	---	--	-----------

LED units digit: During automatic reset of fault display selection.

0 :Action. During automatic reset , Yi and Relay of will update display the Signal based on the Internal state.

1 : No action. During automatic reset,Yi and Relay display Signal No action .

LED tens digit: Lock function selction,to realize display before power-off.

0 :disabled.

1 :enabled.When this function enabled , if the inverter show the fault of power-on for the last time power on.At this time,inverter will display the fault last time result for state,then make sure that users will know about the inverter.

F19.36	Continuous run frequency selection when alarm	Range:0~3	0
---------------	--	------------------	----------

This parameter definite the inverter at fault.If the users choose “Alarm, continues to run” of frequency.

0 :running at the current setting frequency.

1 :running at the upper limiting frequency.

2 :running at the lower limit frequency.

3 :running at the fault Alternate frequency.

F19.37	Abnormal standby frequency	Range:0.00Hz~upper limit frequency	10.00Hz
---------------	-----------------------------------	---	----------------

This parameter definite the alternative running frequency when inverter fault , user can use it along with parameterF19.36.

F19.38	Reserved		
F19.39	Reserved		
F19.40	Reserved		
F19.41	Reserved		
F19.42	Reserved		
F19.43	Reserved		
F19.44	Reserved		

7.21 Internal Virtual Input Output Node Parameter Group:F20

F20.00	Virtual input VDI1 function selection	Range:0~90	0
F20.01	Virtual input VDI2 function selection	Range:0~90	0
F20.02	Virtual input VDI3 function selection	Range:0~90	0
F20.03	Virtual input VDI4 function selection	Range:0~90	0
F20.04	Virtual input VDI5 function selection	Range:0~90	0

VDI1 to VDI5 have the same functions as Xi terminals on the control board and can be used for digital input. For more details, see description of F08.18 to F08.25.

F20.05	Virtual output VDO1 function selection	Range:0~60	0
F20.06	Virtual output VDO2 function selection	Range:0~60	0
F20.07	Virtual output VDO3 function selection	Range:0~60	0
F20.08	Virtual output VDO4 function selection	Range:0~60	0
F20.09	Virtual output VDO5 function selection	Range:0~60	0

VDO functions are similar to the Yi functions on the control board. The VDO can be used together with VDIx to implement some simple logic control.

If VDO function is set to non-0, the function setting and use of VDOx are the same as the output of parameter of Yi. Please refer to descriptions in group F09.

F20.10	Virtual output VDO1 open delay time	Range:0.00~600.00s	0.00s
F20.11	Virtual output VDO2 open delay time	Range:0.00~600.00s	0.00s
F20.12	Virtual output VDO3 open delay time	Range:0.00~600.00s	0.00s
F20.13	Virtual output VDO4 open delay time	Range:0.00~600.00s	0.00s
F20.14	Virtual output VDO5 open delay time	Range:0.00~600.00s	0.00s
F20.15	Virtual output VDO1 close delay time	Range:0.00~600.00s	0.00s
F20.16	Virtual output VDO2 close delay time	Range:0.00~600.00s	0.00s
F20.17	Virtual output VDO3 close delay time	Range:0.00~600.00s	0.00s
F20.18	Virtual output VDO4 close delay time	Range:0.00~600.00s	0.00s
F20.19	Virtual output VDO5 close delay time	Range:0.00~600.00s	0.00s

F20.10~ F20.19 definite the time of open up and shut down terminal.

VDO1~VDO5 definite is the delay time of internal level from open up to shut down.

F20.20	Virtual input VDI enable control	Range:00~FF	00
---------------	---	--------------------	-----------

Parameter F20.20 is to control VDI1~VDI5 is enable .F20.20(BIT0-BIT4) is according to the enable unit VDI1~VDI5,0 stands for disabled , 1 stands for enable.The relations are below :

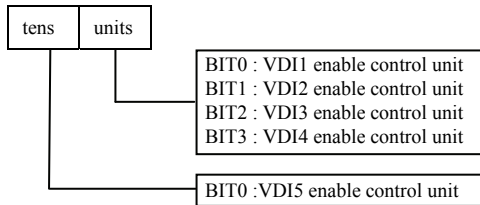

F20.21	Virtual input VDI status digital setup	Range:00~FF	00
---------------	---	--------------------	-----------

Virtual input terminal VDI state is determined by the VDI F20.21 definite virtual input VDI state Digital and virtual output terminal VDO state, the relation between them is logical OR.

Parameter F20.21 BIT0-BIT4 is according to VDI1-VDI5 state , 0 stands for disabled state,1 stands for enabled state.

F20.22	Virtual input:output connection	Range:00~FF	00
---------------	--	--------------------	-----------

Bit0 :The connection of VDI1 and VDO1

0 : positive logic.

1 : negative logic.

Bit1 :The connection of VDI2 and VDO2

0 : positive logic.

1 : negative logic.

Bit2 :The connection of VDI3 and VDO3

0 : positive logic.

1 : negative logic.

Bit3 :The connection of VDI4 and VDO4

0 : positive logic.

1 : negative logic.

Bit4 :The connection of VDI5 and VDO5

0 : positive logic.

1 : negative logic.

Parameter F20.22 definite logical relation if the virtual output

terminal, Bit0~Bit4 is according to logical relation setting of VDI1~VDI5 and VDO1~VDO5 , 0 stands for positive logic , 1 stands for negative logic.



Note

Parameter F20.21 definition VDI state , the Digital setting will not influence by F20.22.

7.22 Reserved parameter group 3: F21

F21.00 ~ F21.21	Reserved		
-------------------------------------	-----------------	--	--

7.23 Reserved parameter group 4: F22

F22.00 ~ F22.17	Reserved		
-------------------------------------	-----------------	--	--

7.24 Reserved parameter group 5: F23

F23.00 ~ F23.17	Reserved		
-------------------------------------	-----------------	--	--

7.25 Reserved parameter group 6: F24

F24.00 ~ F24.13	Reserved		
-------------------------------------	-----------------	--	--





7.26 User Definition Display Parameter Group:F25

F25.00	User function code 1	Range:F00.00~F25.xx	25.00
F25.01	User function code 2	Range:F00.00~F25.xx	25.00
F25.02	User function code 3	Range:F00.00~F25.xx	25.00
F25.03	User function code 4	Range:F00.00~F25.xx	25.00
F25.04	User function code 5	Range:F00.00~F25.xx	25.00
F25.05	User function code 6	Range:F00.00~F25.xx	25.00
F25.06	User function code 7	Range:F00.00~F25.xx	25.00
F25.07	User function code 8	Range:F00.00~F25.xx	25.00
F25.08	User function code 9	Range:F00.00~F25.xx	25.00
F25.09	User function code 10	Range:F00.00~F25.xx	25.00
F25.10	User function code 11	Range:F00.00~F25.xx	25.00
F25.11	User function code 12	Range:F00.00~F25.xx	25.00
F25.12	User function code 13	Range:F00.00~F25.xx	25.00
F25.13	User function code 14	Range:F00.00~F25.xx	25.00
F25.14	User function code 15	Range:F00.00~F25.xx	25.00
F25.15	User function code 16	Range:F00.00~F25.xx	25.00
F25.16	User function code 17	Range:F00.00~F25.xx	25.00
F25.17	User function code 18	Range:F00.00~F25.xx	25.00
F25.18	User function code 19	Range:F00.00~F25.xx	25.00
F25.19	User function code 20	Range:F00.00~F25.xx	25.00
F25.20	User function code 21	Range:F00.00~F25.xx	25.00
F25.21	User function code 22	Range:F00.00~F25.xx	25.00
F25.22	User function code 23	Range:F00.00~F25.xx	25.00
F25.23	User function code 24	Range:F00.00~F25.xx	25.00
F25.24	User function code 25	Range:F00.00~F25.xx	25.00
F25.25	User function code 26	Range:F00.00~F25.xx	25.00
F25.26	User function code 27	Range:F00.00~F25.xx	25.00

F25.27	User function code 28	Range:F00.00~F25.xx	25.00
F25.28	User function code 29	Range:F00.00~F25.xx	25.00
F25.29	User function code 30	Range:F00.00~F25.xx	25.00

This parameter is the User-defined parameter, user can choose the at most 30 from F0 to F30 that are reflect into F25 , in order to check and alter more convenient. Use F25.00 setting the first function code parameter that users plan to. then use F25.01 setting the second function code parameter that users plan to, so, after the maximum 30 User-defined parameter that can define is finished, then setting F00.00=3 (user list view, press ). If users want to drop out user-defined parameter mode, setting F00.00≠3, then press.

For example: user plan to set three User-defined parameter :F02.01, F03.02 和 F04.00 , following the steps below :

- (1) Use F25.00 to set the first function code parameter 02.01, press  ;
- (2) Use F25.01 to set the second function code parameter 03.02 , press  ;
- (3) Use F25.02 to set the third function code parameter 04.00 , press  .
- (4) Set F00.00=3 (user list view, press ) .

After the setting is finished , if users do not change F00.00 function code, when enter function code display state, the operation panel will display F00.00, F02.01, F03.02 and F04.00 only, if the user do not want to display User-defined parameter, setting F00.00 to the display expected mode.



Note

- 1, xx represent function code.
- 2, F25.xx represent no reflection.



Note

When the setting function parameter is not available into the range of EN500 permit, setting the User-defined parameter will not make it.

7.27 Fault Record Function Parameter Group:F26

F26.00	The last fault record	Range:0~50	0
F26.01	The last two fault records	Range:0~50	0
F26.02	The last three fault records	Range:0~50	0
F26.03	The last four fault records	Range:0~50	0

0 : No fault.

1~26 :E-01~E-26 fault.

27~29 :reserved.

30~36 :E-30~E-36 fault.

37~50 :reserved.

F26.00~F26.03 definite the four times before for code of faults and the two times before fault for the voltage,current terminal and etc of inverter , users base on fault code and refer to fault function& fault handle process, then getting the results for different types of fault and reasons.

F26.04	Setup frequency at the last one fault	Range:0.00Hz~upper limit frequency	0.00Hz
F26.05	Output frequency at the last one fault	Range:0.00Hz~upper limit frequency	0.00Hz
F26.06	Output current at the last one fault	Range:0.0~6553.5A	0.0A
F26.07	DC busbar voltage at the last one fault	Range:0.0~6553.5V	0.0V
F26.08	Module temperature at the last one fault	Range:0~125℃	0℃
F26.09	Input terminal status at the last one fault	Range:0000~FFFF	0000
F26.10	Accumulated run time at the last one fault	Range:0~65535h	0h
F26.11	Setup frequency at the last two fault	Range:0.00Hz~upper limit frequency	0.00Hz
F26.12	Output frequency at the last two fault	Range:0.00Hz~upper limit frequency	0.00Hz
F26.13	Output current at the last two fault	Range:0.0~6553.5A	0.0A
F26.14	DC busbar voltage at the last two fault	Range:0.0~6553.5V	0.0V
F26.15	Module temperature at the last two fault	Range:0~125℃	0℃
F26.16	Input terminal status at the last two fault	Range:0000~FFFF	0000

F26.17	Accumulated run time at the last two fault	Range:0~65535h	0h
---------------	---	-----------------------	-----------

F26.04-F26.17 record the running state of fault for the first and second time before.,when Input terminal state at the fault, the terminal state is the whole terminal state after the time delay , including the standard input terminal state and expanded input terminal state .When Virtual terminal communication is set as the terminal panel point , the standard Input terminal state is determined by the actual physical input terminal and Virtual terminal communication .please refer to the details of the Input terminal state :

Bit0:X1(Standard input terminal 1). 1: valid;0: invalid
 Bit1:X2(Standard input terminal 2). 1: valid;0: invalid
 Bit2:X3(Standard input terminal 3). 1: valid;0: invalid
 Bit3:X4(Standard input terminal 4). 1: valid;0: invalid
 Bit4:X5(Standard input terminal 5). 1: valid;0: invalid
 Bit5:X6(Standard input terminal 6). 1: valid;0: invalid
 Bit6:X7(Standard input terminal 7). 1: valid;0: invalid
 Bit7:X8(Standard input terminal 8). 1: valid;0: invalid
 Bit8:EX1(Extended input terminal 1). 1: valid;0: invalid
 Bit9:EX2(Extended input terminal 2). 1: valid;0: invalid
 Bit10:EX3(Extended input terminal 3). 1: valid;0: invalid
 Bit11:EX4(Extended input terminal 4). 1: valid;0: invalid
 Bit12:EX5(Extended input terminal 5). 1: valid;0: invalid
 BIT13:EX6(Extended input terminal 6). 1: valid;0: invalid

7.28 Password and Manufacturer Function Parameter Group:F27

F27.00	User password	Range:00000~65535	00000
---------------	----------------------	--------------------------	--------------

User password setting function is used for preventing unauthorized persons from checking and modifying the functional parameters.



Set F27.00 to 00000 if the user password function is unnecessary.

If user password function is necessary, input a 5-digit none-zero figure, and press



to confirm. The password is effective at once.

To change the password:

Press , input the primary password, select F27.00 (at this time F27.00=00000), then input new password and press  to confirm. The password is effective at once.



Note

Please memorize the password. seek advice from manufacturer in case it is lost.

F27.01	Manufacturer password	Range:00000~65535	00000
---------------	------------------------------	--------------------------	--------------

Factory setting function, the user can't modify.

8 Troubleshooting

8.1 Failure and countermeasure

Possible failure types in EN500 are shown in Table 8-1 ,the fault types including fault and alarm. Such as if inverter fault display E-XX , while the corresponding alarm is displayed in A-XX . Once the inverter failure , fault types are stored in the F26 fault recording parameter group, and if alarm, alarm status has been revealed, until the alarm source release, alarm status are not logged to the F26 parameter group. Some failure code is reserved for intelligent automatic diagnosis function which will be executed continuously in future. When failure takes place in the inverter, the user should check according to note of this table first and record failure phenomena detailedly. Please contact our after-sale service and technical support Department or agent in your local place when technical service is needed.

Table 8-1 Failure type and the countermeasure

Failure code	Failure type	Possible reason	Countermeasure
E-01	Overcurrent during accelerating process	Accelerating time is too short	Prolong accelerating time
		Improper V/F curve	Adjust V/F curve setting, adjust manual torque boost or change to automatic torque boost
		Restart rotating motor	Set speed checking restart function
		Low power source voltage	Check input power supply
		Too small power of the inverter	Choose inverter with high-power
E-02	Overcurrent during decelerating process	Decelerating time is too short	Prolong decelerating time
		Have potential energy load or big Inertia load	Increase braking power of external energy consumption braking subassembly
		Power of inverter is a bit small	Choose inverter with high-power
E-03	Overcurrent during constant speed process	Load change suddenly or have unwonted phenomena	Check or reduce break of the load
		Acce./Dece. time is set to too short	Prolong accelerating decelerating time properly
		low power source voltage	Check input power supply
		Power of inverter is a bit small	Choose inverter with high-power
E-04	Overvoltage during accelerating process	Unwonted input voltage	Check input power supply
		Acce. time is set to too short	Prolong accelerating time properly
		Restart rotating motor	Set speed checking restart function

E-05	Overvoltage during decelerating process	Decelerating time is too short	Prolong decelerating time
		Have potential energy load or big inertia load	Increase braking power of external energy consumption braking subassembly
E-06	Overvoltage during constant speed process	Unwonted input voltage	Check input power supply
		Acce./Dece. time is set to too short	Prolong accelerating decelerating time properly
		Input voltage change abnormally	Assemble reactor
		Load inertia is a bit big	Use energy consumption subassembly
E-07	Inverter control power supply overvoltage	Unwonted input voltage	Check input power supply or look for service
E-08	Low-voltage when running	Input voltage is too low	Check the input voltage
E-09	Inverter overload	Acce. time is set to too short	Prolong accelerating time
		DC injection braking is too big	Reduce DC injection braking current, prolong braking time
		improper V/F curve	Adjust V/F curve and torque boost
		Restart rotating motor	Set speed checking restart function
		power source voltage is too low	check power source voltage
		Load is too big	Choose inverter with high-power
E-10	Motor overload protection	Improper V/F curve	Adjust V/F curve and torque boost
		Power source voltage is too low	check power source voltage
		General motor run at low speed with big load	Can choose frequency conversion motor for long time low speed run
		Motor overload protection factor set incorrectly	to set motor overload protection factor correctly
		Motor blocked up or load change too suddenly and quickly	Check the load
E-11 (A-11)	Motor underload protection	The operating current of inverter less than underload threshold	Confirm whether the parameters F19.08, F19.09 setting are reasonable
		load divorced from motor	Checking whether the load divorced from motor
E-12	The input phase lose	The three-phase input power supply is abnormal	Check the three-phase input power line is off or poor contact
		Power supply board anomaly	Look for service from manufacturer or agent
		The control board anomaly	Look for service from manufacturer or agent

E-13	The output phase lose	The cable from inverter to motor anomaly	Checking the cable
		When the motor runs inverter three-phase output unbalanced	Check whether the motor three-phase winding is balance
		Power supply board anomaly	Look for service from manufacturer or agent
		The control board anomaly	Look for service from manufacturer or agent
E-14	Inverting module protection	Transient overcurrent of the inverter	Refer to countermeasure for overcurrent
		phase to phase short circuit or earthing short circuit of output 3 phase	wiring again
		Air-path blocked or fan damaged	To clear air-path or replace the fan
		Ambient temperature is too high	Lower ambient temperature
		Connecting wire or insert on control board loose	Check and connect the wire again
		Unwanted current wave caused by missing output phase etc.	Check wiring
		Assistant power supply damaged and drive voltage lacking	Look for service from manufacturer or agent
Unwanted control board	Look for service from manufacturer or agent		
E-15	Short circuit to ground when operation	Motor short circuit to ground	The replacement of cable or motor
E-16	Short circuit to ground when power on	Motor short circuit to ground	The replacement of cable or motor
E-17 (A-17)	Inverter overheat	Duct blockage	Cleaning or to improve the ventilation duct
		The ambient temperature is too high	To improve the ventilation conditions, decreasing the carrier frequency
		Fan damage	Change new one
		External fault emergency stop terminal closed	External fault disconnect after external fault terminal
E-18 (A-18)	External device failure	Sudden stop terminal for external failure closed	Open external failure terminal after external failure is settled
E-19	Current detecting circuit failure	Connecting wire or insert on control board loose	Check and connect the wire again
		Assistant power supply damaged	Look for service from manufacturer or agent

		Hall component damaged	Look for service from manufacturer or agent
		Unwonted amplifying circuit	Look for service from manufacturer or agent
E-20	External interference failure	External disturbance serious	Press "STOP/RESET" button to reset or add external power supply filter from power input side
E-21	External interference failure	External disturbance serious	Power off and restart, if the failure persists, seek the manufacturer or dealer service
E-22 (A-22)	PID Given loss	PID given loss threshold setting is not reasonable	To reset the relevant parameters
		External given disconnection	Check external given wiring
		The control board anomaly	Look for service from manufacturer or agent
E-23 (A-23)	PID feedback loss	PID feedback loss threshold setting is not reasonable	To reset the relevant parameters
		Feedback signal disconnection	Check external feedback signal wiring
		The control board anomaly	Look for service from manufacturer or agent
E-24 (A-24)	PID error amount abnormal	PID error abnormal detection threshold setting is not reasonable	To reset the relevant parameters
		The control board anomaly	Look for service from manufacturer or agent
E-25	Start terminal protection	Terminal command effective when power on .	Check the external input terminal state
E-26 (A-26)	Communication failure	Baud rate set improperly	set Baud rate properly
		Serial port communication error	Press "STOP/RESET" key to reset, look for service
		Failure warning parameter set improperly	Modify F05.04, F05.05
		Upper device doesn't work	Check if upper device work and wiring is correct
E-27	Reserved		
E-28	Reserved		
E-29	Reserved		
E-30 (A-30)	E ² PROM read and write wrongly	Mistake take place when read or write control parameter	Reset by pressing "STOP/RESET" Look for service from manufacturer or agent
E-31	Temperature detecting disconnection	Temperature sensor fault	Look for service from manufacturer or agent
		The temperature detection circuit anomaly	Look for service from manufacturer or agent

E-32	Self tuning failure	Parameter setting not according to the motor nameplate	set parameter correctly according to the motor nameplate
		current anomaly when tuning	Select inverter match the motor
		Motor wiring error	Check the motor three-phase wiring
E-33 (A-33)	Contactor anomaly	Power board anomaly	Look for service from manufacturer or agent
		Contactor anomaly	Replace contactor
E-34	The fault 1	Debugging use in factory	
E-35	The fault 2	Debugging use in factory	
E-36 (A-36)	The bus capacitor overheating	Poor cooling environment	Improve the inverter heat dissipation environment
		The inverter capacity is too small	Select inverter match motor
		Bus capacitance cooling fan is damaged	Replace the bus capacitor cooling fan
E-37 ~ E-50	Reserved		
A-51	The main and auxiliary given frequency channel exclusiveness alarm	Parameter setting error	F01.00 and F01.03 cannot be set to the same channel (9: terminal encoder given except)
A-52	Terminal function exclusiveness alarm	Terminal function parameters setting repeatedly	Check the terminal function settings

8.2 Failure record lookup

This series inverter can record latest 4 failure code and inverter run parameter of the last 2 times failure, to search these information can redound to finding out reason of the failure.

Failure information is all stored in F26 group parameter, please enter into F26 group parameter to see about information by referring to keypad operation method.

Code	Content	Code	Content
F26.00	Previous one failure record	F26.09	Input terminal state at previous failure
F26.01	Previous two failure record	F26.10	Total running time at previous failure
F26.02	Previous three failure record	F26.11	set freq. at previous 2 failure
F26.03	Previous four failure record	F26.12	output freq. at previous 2 failure

F26.04	Set freq. at previous failure	F26.13	output current. at previous 2 failure
F26.05	Output freq. at previous failure	F26.14	DC bus volt. at previous 2 failure
F26.06	Output current. at previous failure	F26.15	Module temp. at previous 2 failure
F26.07	DC bus volt. at previous failure	F26.16	Input terminal state of previous 2 failure
F26.08	Module temp. at previous failure	F26.17	Total running time of previous 2 failure

8.3 Failure reset



- (1) Before reset you must find out reason of failure downright and eliminate it, otherwise may cause permanent damage to the inverter.**
- (2) If can't reset or failure takes place again after resetting, should look for reason and continuous resetting will damage the inverter.**
- (3) Reset should take place 5 minutes later after overload, overheat protection action.**
- (4) For the failure of E-14, the reset is invalid, the motor wiring should be checked after power off, and restart the inverter.**

To resume normal running when failure takes place in the inverter, you can choose following any kind of operation:

- (1) After you set any terminal of X1~X8 to be inputted by external RESET, it will be disconnected after connected to COM.
- (2) When failure code is displayed, press  key after restoration is Confirmed.
- (3) Communication reset. Please refer to annex description.
- (4) Cut off power supply.

8.4 Alarm reset

When an alarm occurs, must eliminate alarm source which cause alarm, otherwise the alarm can not be eliminated, also cannot be reset by button reset.

9 Maintenance

9.1 Routine maintenance

When you use this series you must assemble and operate it according to demand listed in this “service manual” strictly. During run state, temperature, humidity, vibration and aging parts will affect it, which may cause failure of the inverter. To avoid this, it is recommended to perform routine inspections and maintenance.

Table 9-1 Daily inspection and maintenance items

period		Inspection item
daily	periodic	
√		Daily cleaning: (1) Inverter should be maintained in a clean state (2) Clean up the dust on the surface of inverter, prevent the dust into the inverter internal (especially metal dust). (3) Clean up the oil stain of cooling fan
	√	Check the air duct, and regularly clean.
	√	Check whether the screws is loose
	√	Check whether the inverter is corrode
√		Whether inverter installation environment changes
√		Whether the inverter cooling fan is working properly
√		Whether the inverter is overheating
√		When running whether voice of motor abnormal change.
√		Whether occur abnormal vibration when motor running
	√	Check wiring terminals have arc trace
	√	The main circuit insulation test

Recommend to inspect with following instrument:

Input voltage: electric voltmeter; output voltage: rectifying voltmeter; input output current: pincers ammeter.

9.2 Inspection and replacement of damageable parts

Some component parts in the inverter will be abraded or bear descending performance for long-term usage, to assure that the inverter can run stably and reliably, it is recommended to perform defending maintenance and replace corresponding parts if necessary.

(1) cooling fan

Abnormal noise, even oscillation may take place if the fan have wearing bearing, aging blade, here replacement of the fan should be considered.

(2) filter electrolyte capacitance

When frequent-changing load causes increasing pulsant current and aging electrolyte under high ambient temperature, the electrolyte capacitance may be damaged and here should replace it.

9.3 Repair guarantee

(1) We provide the free maintenance within warranty time if any failure or damage under normal usage, the warranty time can be seen in the warranty card, we will charge some when exceed warranty time.

(2) We will take some upkeep if one of following situations takes place within period of repair guarantee.

a. If did not use the inverter according to 《service manual》 strictly or did not use it under ambient demanded in 《service manual》 , which cause failure.

b. Failure caused by applying the inverter to non-normal function;

c. Failure caused by self-repair, refit which is not already allowed;

d. Damage caused by bad keeping, falling down from high place or other extrinsic factor after purchasing the inverter;

e. Failure caused by natural disaster or its reason such as unwonted voltage, thunderbolt, water fog, fire, salt corroding, gas corroding, earthquake and storm etc.;

f. Make bold to tear up product logo (such as: nameplate etc.); Body serial number don't accord with that in repair guarantee card.

(3) We calculate service fee based on actual cost, which is subject to contract if any.

(4) You can contact the agent and also our company directly if you have questions. After repair guarantee period, we shall also provide lifetime charged repair service for our products.



Note

Our company will also provide lifetime repair service with fee for inverter which is not within period of repair guarantee.

9.4 Storage

The user must pay attention to following points for temporary storage and long-term storage after purchasing the inverter:

- (1) Avoid storing the inverter in high temperature, moist place and place of dust, metal powder and assure good ventilation.
- (2) Longtime storage will cause low quality of electrolyte capacitance, so must assure that it's electrified for one time within 1 year and electrification time is not shorter than 1 hour and input voltage must be increased to rated value gradually by voltage regulator of 250w, meanwhile the inverter should be cutted off from the motor.

10 Modbus communication protocol

10.1 Summarization

We provide general RS485 communication interface in our inverters for the user. Through this communication interface upper device (such as HMI, PC, PLC controller and etc.) can perform centralized monitor to the inverter (such as to set inverter parameter, control run of inverter, read work state of the inverter).

This communication protocol is interface criterion file designed for realizing above-mentioned function, please read it earnestly and program according to it so that realize long-distance and network control to the inverter.

10.2 Communication net buildup mode

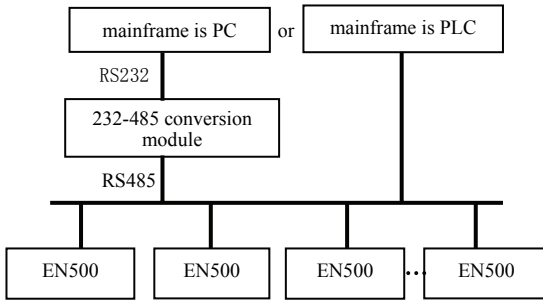

Fig.1 net buildup graph

10.3 Communication mode

At present, EN500 inverter can be used only as auxiliary device in RS485 net. Can realize communication between inverters through PC, PLC or HMI if it's needed. Specific communication mode is as mentioned below:

- (1) PC or PLC as mainframe, inverter as auxiliary device, point-to-point communication between mainframe and auxiliary device.
- (2) Auxiliary device don't response when mainframe send out command by broadcast address.
- (3) User can set local address, baud rate and data format of the inverter through auxiliary device keypad or serial communication mode.
- (4) EN500 provides optional RS485 interface.
- (5) Default mode: Asynchronous serial, semiduplex transport mode. RTU and ASII two mode. Default format and transport rate: 8-N-1, 9600bps.

10.4 Data communication structure

10.4.1 Data frame format

Using RTU mode, messages are sent at least 3.5 character time interval pause. The first transmitted field is device address, the character you can transfer is hexadecimal 0x00 ~ 0xFF. Network equipment continuously monitor the bus, including pauses. When the address field is received, all equipment determine whether it is sent to their own. when the last character of the packet transfer is complete, at least a 3.5 character times pause mean the end of the message. A new message can begin after this pause.

The entire message frame must be transmitted as a continuous flow. If a new message start transmitting in less than 3.5 character times after a message and then receiving device will consider it a continuation of the previous message. This will cause an error, because in the final CRC field value can not be right.

RTU frame format as the table below:

Frame Header	3.5 characters time pause
Slave address	Slave address: 0~247
Communication command code	03H: read slave parameter 06H: write slave parameter
Data content DATA	The contents of packet: Parameter address (16bit) ; Number of parameter or bytes of parameter value; Parameter value (16bit)
Data content DATA	
.....	
.....	
CRC check value low byte	16bit Unsigned check value
CRC check value high byte	
Closing Flag	3.5 characters time pause

Regarding generation method of CRC check value, please refer to 10.8.
ASCII frame format as the table below:

Frame Header	';' (0x3A)
Slave address Hi	Slave address: Combined by 2 ASCII code
Slave address Lo	8 bit slave address 0~247
Command code Hi	Command code: 8 bit command code combined by 2 ASCII code
Command code Lo	03H: read slave parameter 06H: write slave parameter
Data content DATA	The contents of data packet:
Data content DATA	N pieces of 8bit data content combined by 2*N pieces of ASCII code
.....	
.....	
LRC CHK Hi	LRC check value includes 2 pieces of ASCII code
LRC CHK Lo	
Closing Flag Hi	Closing Flag Hi = CR (0x0D)
Closing Flag Lo	Closing Flag Lo = LF (0x0A)

10.4.2 Host read slave parameter

Command code 03H. Host can read or one or more parameter(up to ten) by initiating a communication transaction .

E.g., read 2 contiguous inverter parameter values from the address 0000H of inverter whose address is 01, the contents of host command :

ADR	01H
CMD	03H
Parameters initial address high byte	00H
Parameters initial address low byte	00H
Number of parameter high byte	00H
Number of parameter low byte	02H
CRC check value low byte	Be calculated
CRC check value high byte	Be calculated

The contents of slave reply:

ADR	01H
CMD	03H
Parameter value bytes	04H
Address 0000H content high byte	00H
Address 0000H content low byte	00H
Address 0001H content high byte	00H
Address 0001H content low byte	03H
CRC check value low byte	Be calculated
CRC check value high byte	Be calculated

10.4.3 Host write slave parameter

Command code 06H. Host can write an parameter by initiating a communication transaction .

E.g.,The decimal system 5000 (1388H) written to the inverter 0101H address whose slave address is 02, host command including:

ADR	02H
CMD	06H
Parameter address high byte	01H
Parameter address low byte	01H
Parameter value high byte	13H
Parameter value low byte	88H
CRC check value low byte	Be calculated
CRC check value high byte	Be calculated

The contents of slave reply:

ADR	02H
CMD	06H
Parameter address high byte	01H
Parameter address low byte	01H
Address 0101H content high byte	13H
Address 0101H content low byte	88H
CRC check value low byte	Be calculated
CRC check value high byte	Be calculated

10. 5 Data communication address allocation

10.5.1 Function code F00-F26 group communication address

Inverter function parameter's MODBUS communication address addressing process follows PPnn way: PP means high byte of the address, corresponding to function parameter's group number; nn means low byte of the address, corresponding to function code parameter's group internal code. For example: F3.21 function code's communication address is 0315H, 03H is the hex form of group number 3, 15H is the hex form of group internal code 21.

F00.00~F26.17 communication address is 0000H~1A11H, F26 group fault record parameter start address is 1A00H.

10.5.2 control command and status word communication address

Variable Name	Communication address	Reading-writing attribute	Command data or response value meaning
Run command word	1E 00H	Reading and writing	1: reserved
			2: reserved
			3: forward JOG run
			4: reversal JOG run
			5: run
			6: stop
			7: forward run
			8: reversal run
			9: fault reset
			10: reserved
Serial port value setting	1E 01H	Reading and writing	0~10000(0~max)
Inverter status	1E 02H	Reading only	BIT0: bus voltage set BIT1: the ordinary run command effectively BIT2: JOG command effectively BIT3: Running BIT4: the current running direction is reverse BIT5: the operating instructions is reverse direction BIT6: deceleration braking BIT7: acceleration BIT8: deceleration BIT9: alarm BIT10: fault BIT11: current limit BIT12: fault self recovery BIT13: self tuning BIT14: Free stop State BIT15: speed tracking start
Alarm code	1E 03H	Reading only	0: no alarm 1 ~ 50: the current alarm code

10.5.3 Monitor parameter communication address

Variable name	Communication address	read-write attribute	Command data or response value
C-00	1C00H	Reading	Monitoring parameters 1
C-01	1C01H	Reading	Monitoring parameters 2
C-02	1C02H	Reading	Monitoring parameters 3
C-03	1C03H	Reading	Monitoring parameters 4
C-04	1C04H	Reading	Monitoring parameters 5

C-05	1C05H	Reading	Monitoring parameters 6
------	-------	---------	-------------------------

10.5.4 Inside hidden parameters

Variable name	Communication address	read-write attribute	means of command data or response value
Reserved	1D00H	/	
Reserved	1D01H	/	
Communication AO1 given value	1D02H	read-write	Range: 0~4000
Communication AO2 given value	1D03H	read-write	Range: 0~4000
Communication EAO1 given value	1D04H	read-write	Range: 0~4000
Communication EAO2 given value	1D05H	read-write	Range: 0~4000
Communication HDO given value	1D06H	read-write	Range: 0~4000
Communication EHDO given value	1D07H	read-write	Range: 0~4000
The communication terminal output given value	1D08H	read-write	BIT0: Y1 BIT1: Y2 BIT2: Y3 BIT3: Y4 BIT4: RLY BIT5: EY1 BIT6: EY2 BIT7: EY3 BIT8: EY4 BIT9: ERLY1 BIT10: ERLY2
Communication virtual input terminal given value	1D09H	read-write	BIT0: CX1 ... BIT7: CX8
Reserved	1D0AH	/	
Reserved	1D0BH	/	
Reserved	1D0CH	/	
Reserved	1D0DH	/	

10.6 Communication error processing

Inverter receiving data packet detection error, it finds reading&writing parameter address or parameter value invalid, so reply to the host with communication error response packet. Communication error response packet (host command code +80H) as command code, with 1 byte error code.

Format for communication error response packet as follows:

ADR	01H
CMD	83H/86H
Communication error code	01H~06H (for details, please check below table)
Low byte of CRC checksum	Obtain by calculating
High byte of CRC checksum	Obtain by calculating

Meaning for each communication error code value as follows:

Communication error code value	Communication error type	Priority
0x01	CRC checksum error	1
0x02	Command code illegal	2
0x03	Register address visited illegal	3
0x04	Value to register illegal	4
0x05	Not allow to modify parameters	5
0x06	Register number read illegal	6

10.7 Data frames examples

10.7.1 RTU Mode

1. Start 1# inverter running

Data Field	Auxiliary Inverter Address	Order code	Register address High byte	Register address Low byte	Data High byte	Low High byte	CRC high bit	CRC Low bit
host command frames	01	06	1E	00	00	05	4F	E1
Auxiliary respond frames	01	06	1E	00	00	05	4F	E1

2. Stop 1# inverter running

Data Field	Auxiliary Inverter Address	Order code	Register address High byte	Register address Low byte	Data High byte	Low High byte	CRC high bit	CRC Low bit
host command frames	01	06	1E	00	00	06	0F	E0
Auxiliary respond frames	01	06	1E	00	00	06	0F	E0

3. Set 1# inverter given value to 50Hz

Data Field	Auxiliary Inverter Address	Order code	Register address High byte	Register address Low byte	Data High byte	Low High byte	CRC high bit	CRC Low bit
host command frames	01	06	1E	01	13	88	D3	74
Auxiliary respond frames	01	06	1E	01	13	88	D3	74

4. Read 1# inverter running state

Data Field	Auxiliary Inverter Address	Order code	Register address High byte	Register address Low byte	Data High byte	Low High byte	CRC high bit	CRC Low bit
host command frames	01	03	1E	02	00	01	23	E2
Auxiliary respond frames	01	03	(Respond value byte quantity) 02		00	01	79	84

10.7.2 ACSII Mode**Start 1# inverter running**

Data Field	Frame start symbol	Auxiliary Inverter Address	Order code	Register address High byte	Register address Low byte	Data High byte	Low High byte	LRC checking	Ending mark
host command frames	:	01	06	1E	00	00	05	D6	CR(enter) 4F(newline)
Auxiliary respond frames	:	01	06	1E	00	00	05	D6	CR.LF

LRC check code generation:

Check code = (Auxiliary address+Order code + Register address

High byte+Register address low byte+ Data High byte+Data low byte) 's sixteen hexadecimal 's Complement

Follow above to start the #1 inverter operation command LRC code generation process:

$0xD6 = 0x100 (0x01+0x06+0x1E+0x00+0x00+0x05)$

10.8 CRC checksum mode

CRC checksum value calculating function written by C language is as follows:

```
unsigned int cal_crc_value (unsigned char *pval, unsigned char len)
{
    unsigned int crc_value=0xFFFF;
    unsigned int i;

    while(len--)
    {
        crc_value ^= *pval++;
        for(i=0; i<8; i++)
        {
            if(crc_value & 0x0001)
            {
                crc_value >>= 1;
                crc_value ^= 0xA001;
            }
            else
            {
                crc_value >>= 1;
            }
        }
    }
    return(crc_value);
}
```



Address: 5-6F, Bldg.4, Minqi Technology Park,
Lishan Rd., Nanshan Area, Shenzhen 518055, China
E-mail: encvfd@encvfd.com
Website: <http://www.encvfd.com>